



# COMPACT ATTACHMENTS



# YOUR "ONE-STOP SHOP"

## FOR HYDRAULIC TOOLS AND ATTACHMENTS



Paladin is the trusted name and global leader for quality, productive, and powerful mini, compact, and heavy equipment attachments. Our hydraulic tools and attachments are made to work as hard as the people that use them.

# FEATURED PRODUCT

## FD60 FORESTRY DISK MULCHER



### Maximize Productivity and Up-Time

- Wide-angle intake promotes mulching and helps avoid jams
- Ultra-efficient drive system starts up fast and delivers tremendous power to the head

### Minimize Service Time and Costs

- Zero-maintenance bearing housing never needs to be greased
- Reinforced debris shovel keeps teeth out of the dirt and places material perfectly for optimal processing
- Interchangeable QUADCO teeth simplifies service and allows for tooth rotation to combat uneven wear patterns

### Flexible Across Applications

- Control debris projection with a two-position, adjustable deflector
- Removable debris shovel allows teeth to work below grade and provides easier processing of light brush
- Dual-function push bar smoothly pulls trees in on the right side, grabs to manipulate trees on the left side

### Reap the Benefits of Superior Power

Paladin MulchPower™ Technology provides live, dynamic power and loading feedback to the operator through a unique pressure monitoring gauge. With MulchPower™ operators can see when the tool is fully charged and also when it is nearing a state of being overloaded, so that operating technique can be adjusted to maximize performance.



- **RUN AT PEAK POWER:** Greater starting power improves cutting efficiency and tool life, increasing overall job productivity and decreasing total operating costs.
- **AVOID JAMMING:** Greater starting power dramatically reduces the likelihood of jamming and stalling.
- **WORK WITH CONFIDENCE:** Conditions change from job to job. MulchPower™ lets you be more aggressive when the job will allow it, letting you maximize your production.

# MANUFACTURING FACILITIES

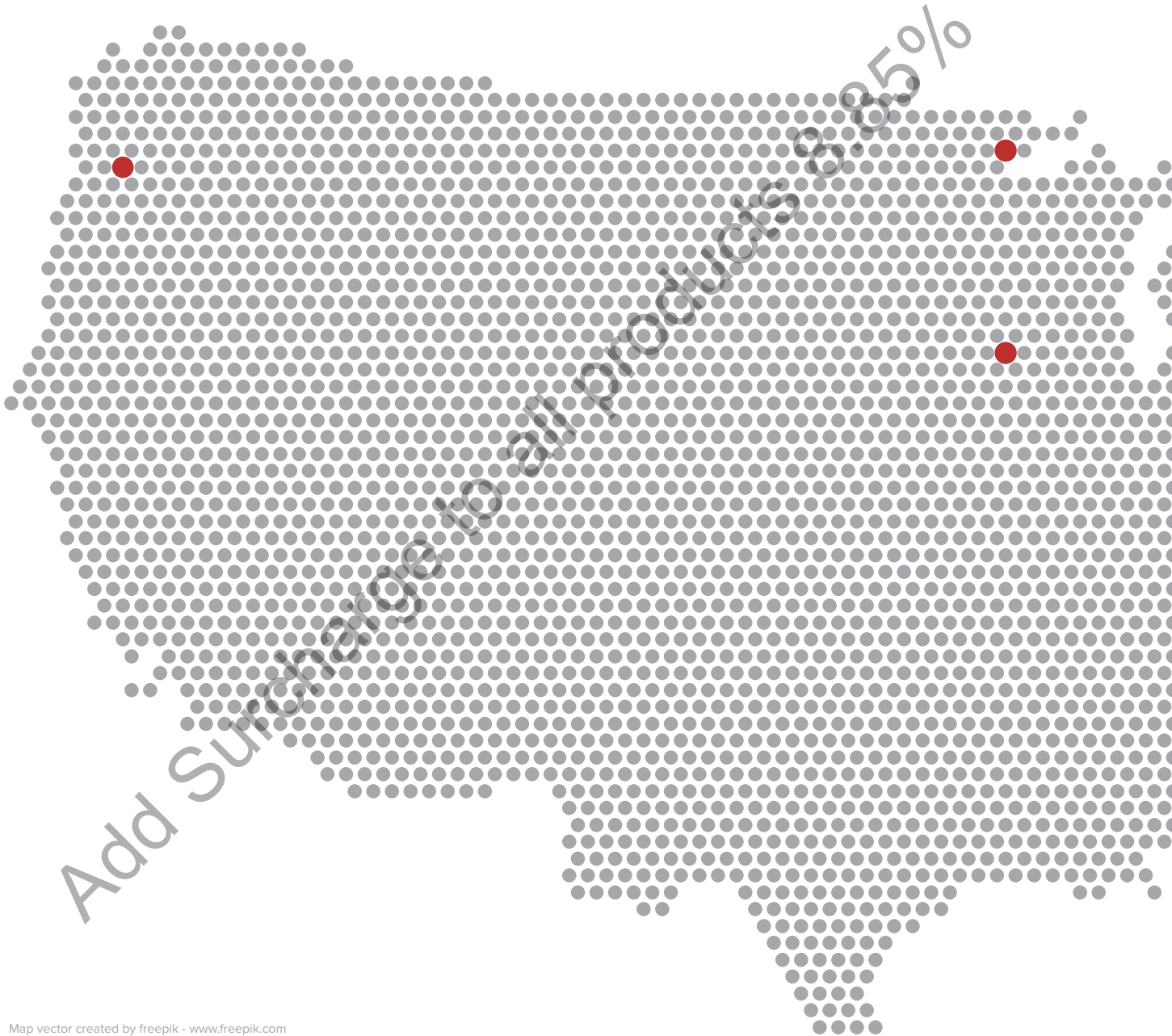

Map vector created by freepik - www.freepik.com

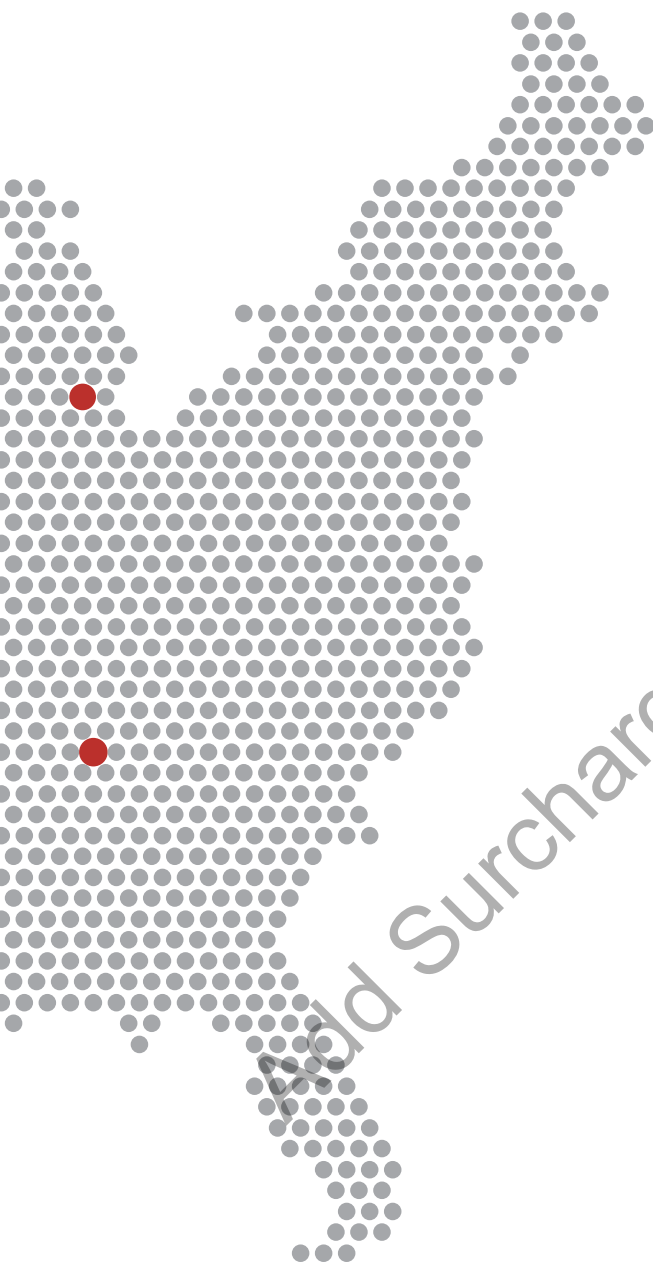

### **Dexter Facility**

2800 Zeeb Road  
Dexter, MI, 48130

### **Delhi Facility**

503 Gay Street  
Delhi, IA, 52223

### **Ooltewah Facility**

8822 Apison Pike  
Ooltewah, TN, 37363

### **Surrey Facility**

19490 92<sup>nd</sup> Avenue  
Surrey, B.C. Canada V4N 4G7

### **Milwaukie Facility**

3810 SE Naef Road  
Milwaukie, OR 97267

### **Two Harbors Facility**

1538 Hwy 2  
Two Harbors, MN 55616

Add Surcharge to all products 8.85%

## AVAILABLE OPTIONS



HEAVY-DUTY BUMPER



GRILLE GUARD



SWEEPS



TOP GUARD W/ LIGHT GUARDS



HYDRAULIC CONNECTOR GUARD



INTAKE SCREENS



FRONT LIGHT GUARDS



SIDE WINDOW GUARDS

## FEATURES AND BENEFITS

- Heavy-duty design protects machine from harsh forestry, scrap, and demolition environments while maintaining visibility and functionality
- Rear screen utilizes quick-release latches, allowing for quick egress in emergency situations
- Grille guard provides protection while maintaining easy access to engine compartment
- Modular kit design allows customization of guarding level
- Installation may require minimal welding to machine frame

## MACHINE COMPATIBILITY

Available for 90+ HP T4F Machines:

- |           |        |
|-----------|--------|
| • DL55    | • C234 |
| • SR270B  | • C238 |
| • SV300   | • C334 |
| • SV340/B | • C345 |
| • TR340/B | • C362 |
| • TV380   | • C334 |
| • TV450/B |        |
| • TV620B  |        |

## AVAILABLE OPTIONS



HEAVY-DUTY TOP GUARD



FRONT LIGHT GUARDS



REAR LIGHT GUARDS



HYDRAULIC CONNECTOR GUARD



REAR GUARD



DEBRIS SHIELD

## FEATURES AND BENEFITS

- Heavy-duty design protects machine from harsh forestry, scrap, and demolition environments while maintaining visibility and functionality
- Rear screen provides protection without compromising airflow
- Grille guard provides protection while maintaining easy access to engine compartment
- Bolt-on design: installation requires no modification

## MACHINE COMPATIBILITY

Available for Kubota SVL Machines:

- SVL75-2
- SVL90-2
- SVL95-2/2S
- SVL97-2
- Does not fit SSV machines

# Warranty Period and Covered Products

WARRANTY PERIOD	COVERED PRODUCTS		
	BRAND	PRODUCT	
FIVE YEARS	PENGO	CS SERIES - GEARBOX ONLY. NOTE: Requires annual maintenance performed	
THREE YEARS	PENGO	CS SERIES - HYDRAULIC MOTOR NOTE: Requires annual maintenance performed	
TWO YEARS	STRIKE FORCE	HYDRAULIC TOOLS (BREAKERS, PLATE COMPACTORS & WHEEL COMPACTORS)	
	PENGO	GEARBOX (OR 500 OPERATIONAL HOURS WHICHEVER COMES FIRST). NOTE: PENGO Drives are not warranted for DTH applications.	
ONE YEAR	JRB	WHEEL LOADER COUPLERS (JRB E SERIES, 416, 418, 420, 422 & ISO SERIES)	
	BRADCO:	BACKHOES, TRENCHERS, DOZER BLADES, PALLET FORKS, GRAPPLE BUCKETS, 4-IN-1 BUCKETS, DIRT BUCKETS, TREE SPADES, POST DRIVERS, STUMP GRINDERS, MULCHERS, COLD PLANERS, BRUSH CUTTERS, FLAIL MOWERS, TREE SHEARS, JAWZ GRABBING TOOL, QUICK PIK MULTI-PURPOSE GRAPPLE, VIBRATORY ROLLER, VIBRATORY PLOW, ROCK SAWS, SILAGE DEFACER, MINI SKID STEER PRODUCTS	
	CP	ALL PRODUCTS	
	CUSTOM WORKS	ALL PRODUCTS (OTHER THAN JRB CUSTOM WORKS)	
	CWS	ALL PRODUCTS	
	FFC	ALL PRODUCTS	
	HARLEY	ALL PRODUCTS	
	MCMILLEN	ALL PRODUCTS	
	SWEEPSTER	ALL PRODUCTS	
	JRB	ALL PRODUCTS (EXCEPT CUSTOM WORKS & HITCH LATCH KITS)	
	PENGO	ALL PRODUCTS	
	PENGO	CS SERIES - ENTIRE DRIVE UNIT	
	90 DAYS	JRB	CUSTOM WORKS & HITCH LATCH KITS
		BRADCO	REAR STABILIZER KITS
JRB		HITCH LATCH KITS	
PALADIN		NEW REPLACEMENT PARTS	

NOTE: JRB couplers and JRB adapters are manufactured to interface only with JRB attachments, OEM attachments and JRB female adaptors (ribs) and the use of a JRB coupler or a JRB adapter with any other attachments (including non-standard attachments, OEM attachments or JRB female adaptors (ribs)) may not be covered and has the potential to void warranty.

JRB hydraulic kits and couplers are designed and tested to be used together. The use of a non-JRB coupler with a JRB kit or the use of a non-JRB kit with a JRB coupler may not be covered and has the potential to void warranty.



For comprehensive warranty information, please visit [www.paladinattachments.com/support/warranty-information](http://www.paladinattachments.com/support/warranty-information), or scan the QR code.

# TABLE OF CONTENTS

<p>ADAPTERS</p>  <p><b>18</b></p>	<p>CS AUGER DRIVES</p> <p><b>NEW</b></p>  <p><b>22</b></p>	<p>CS AUGER MOUNTS</p>  <p><b>25</b></p>	<p>PENGO DT-5 AUGER DRIVES</p>  <p><b>26</b></p>	<p>PENGO DT-15 AUGER DRIVES</p>  <p><b>27</b></p>
<p>PENGO DV-20 AUGER DRIVES</p>  <p><b>28</b></p>	<p>PENGO DV-30 AUGER DRIVES</p>  <p><b>29</b></p>	<p>PENGO DV-40 AUGER DRIVES</p>  <p><b>30</b></p>	<p>PENGO AUGER MOUNTS</p>  <p><b>32</b></p>	<p>LANDSCAPE AGGRESSOR AUGER BITS</p>  <p><b>37</b></p>
<p>AGGRESSOR AUGER BITS</p>  <p><b>38</b></p>	<p>AGGRESSOR TREE AUGER BITS</p>  <p><b>39</b></p>	<p>TRIMAX AUGER BITS</p>  <p><b>40</b></p>	<p>SEVERE ROCK RIPPER AUGER BITS</p>  <p><b>42</b></p>	<p>AUGER TEETH</p>  <p><b>43</b></p>
<p>PILOT BITS</p>  <p><b>44</b></p>	<p>BORH AND EXTENSIONS</p>  <p><b>45</b></p>	<p>HUBS AND INSTALL TOOLS</p>  <p><b>46</b></p>	<p>QUICK CHANGE EXCAVATOR AUGERS</p>  <p><b>47</b></p>	<p>EXCAVATOR AUGERS</p>  <p><b>50</b></p>
<p>BALE/HAY GRAPPLE BUCKET</p>  <p><b>56</b></p>	<p>BALE/HAY GRAPPLE BUCKET HEAVY-DUTY</p>  <p><b>57</b></p>	<p>BALE CARRIAGE - DUAL LARGE SQUARE</p>  <p><b>58</b></p>	<p>BALE HUGGER</p>  <p><b>59</b></p>	<p>BALE SPEARS</p>  <p><b>60</b></p>
<p>BOOMS - LOADER</p>  <p><b>62</b></p>	<p>BOOMS - TREE</p>  <p><b>63</b></p>	<p>BOOMS - TRUSS</p>  <p><b>63</b></p>	<p>GROUND SHARK - STANDARD DUTY</p>  <p><b>70</b></p>	<p>GROUND SHARK - HEAVY DUTY</p>  <p><b>72</b></p>
<p>GROUND SHARK - HIGH PERFORMANCE</p> <p><b>NEW</b></p>  <p><b>74</b></p>	<p>GROUND SHARK - EXTREME DUTY</p>  <p><b>76</b></p>	<p>SSL GUARDING PACKAGES</p>  <p><b>78</b></p>	<p>MX SERIES BRUSH CUTTER</p>  <p><b>80</b></p>	

Note: All manufacturer's names, symbols, numbers and descriptions are used for reference purposes only and does not mean that any part is the product of these manufacturers or approved by these manufacturers.

# TABLE OF CONTENTS

<p>LOW PROFILE LONG FLOOR BUCKETS</p>  <p><b>87</b></p>	<p>LOW PROFILE STANDARD FLOOR BUCKETS</p>  <p><b>88</b></p>	<p>BUCKET ACCESSORIES</p>  <p><b>90</b></p>	<p>4-IN-1 STANDARD DUTY MULTI-PURPOSE BUCKETS</p>  <p><b>92</b></p>	<p>4-IN-1 HEAVY DUTY MULTI-PURPOSE BUCKETS</p>  <p><b>93</b></p>
<p>4-IN-1 MULTI-PURPOSE BUCKETS</p>  <p><b>95</b></p>	<p>FORK POCKET BUCKET</p>  <p><b>98</b></p>	<p>HEAVY-DUTY CONSTRUCTION BUCKETS</p>  <p><b>99</b></p>	<p>HEAVY-DUTY GENERAL PURPOSE BUCKETS</p>  <p><b>101</b></p>	<p>HEAVY-DUTY MATERIAL BUCKET</p>  <p><b>105</b></p>
<p>HEAVY-DUTY AG LOADER TRACTOR BUCKET</p>  <p><b>107</b></p>	<p>HIGH-CAPACITY HEAVY-DUTY BUCKET</p>  <p><b>109</b></p>	<p>HIGH-CAPACITY LIGHT MATERIAL BUCKET</p>  <p><b>110</b></p>	<p>HIGH DUMP BUCKET</p>  <p><b>111</b></p>	<p>LARGE FRAME SKID-STEER BUCKET</p>  <p><b>112</b></p>
<p>LIGHT MATERIAL LOADER BUCKETS</p>  <p><b>113</b></p>	<p>ROCK BUCKET <b>NEW</b></p>  <p><b>114</b></p>	<p>COLD PLANER</p>  <p><b>118</b></p>	<p>COLD PLANER SERIES II</p>  <p><b>120</b></p>	<p>CONCRETE CHUTER</p>  <p><b>122</b></p>
<p>CONCRETE CLAW</p>  <p><b>122</b></p>	<p>COUPLERS</p>  <p><b>123</b></p>	<p>DOZER BLADE</p>  <p><b>124</b></p>	<p>FLAIL MOWERS</p>  <p><b>125</b></p>	<p>CAR FORK CARRIAGES</p>  <p><b>130</b></p>
<p>PALLET FORK FRAME</p>  <p><b>131</b></p>	<p>PALLET RAIL STYLE FORK</p>  <p><b>135</b></p>	<p>FLOATING PIN CARRIAGES</p>  <p><b>136</b></p>	<p>PALLET FORK FRAME - SHAFT</p>  <p><b>137</b></p>	<p>FORK POSITIONERS - SIDE SHIFT</p>  <p><b>137</b></p>
<p>FORK POSITIONERS - SIDE TILT WITH FLOATING PIN</p>  <p><b>138</b></p>	<p>FORKS - BLOCK TINES</p>  <p><b>141</b></p>	<p>FORKS - FLOATING PIN</p>  <p><b>142</b></p>	<p>HOOK ON FORKS</p>  <p><b>144</b></p>	

Note: All manufacturer's names, symbols, numbers and descriptions are used for reference purposes only and does not mean that any part is the product of these manufacturers or approved by these manufacturers.

# TABLE OF CONTENTS

<p>ITA TINES</p>  <p><b>144</b></p>	<p>SHARKBITE GRAPPLE</p>  <p><b>146</b></p>	<p>HEAVY-DUTY BRUSH GRAPPLES <b>NEW</b></p>  <p><b>147</b></p>	<p>STANDARD-DUTY BRUSH GRAPPLES</p>  <p><b>148</b></p>	<p>HEAVY-DUTY SCRAP GRAPPLES</p>  <p><b>150</b></p>
<p>HEAVY-DUTY SCRAP GRAPPLES - MODEL 120</p>  <p><b>151</b></p>	<p>HEAVY-DUTY SCRAP GRAPPLES - MODEL 130</p>  <p><b>154</b></p>	<p>STANDARD-DUTY SCRAP GRAPPLES</p>  <p><b>155</b></p>	<p>LOG GRAPPLE</p>  <p><b>156</b></p>	<p>SKELETON FORK &amp; GRAB</p>  <p><b>157</b></p>
<p>TRASH CLAMP</p>  <p><b>157</b></p>	<p>LAND SCULPTOR</p>  <p><b>158</b></p>	<p>FORK MOUNTED CRANE HOOK</p>  <p><b>159</b></p>	<p>LIFTING HOOK</p>  <p><b>159</b></p>	<p>AUXILIARY HYDRAULIC CONVERSION KIT</p>  <p><b>160</b></p>
<p>MANURE PUSH</p>  <p><b>161</b></p>	<p>MINI ADAPTERS</p>  <p><b>164</b></p>	<p>MINI AUGER DRIVES <b>NEW</b></p>  <p><b>165</b></p>	<p>MINI ANGLE BROOM</p>  <p><b>167</b></p>	<p>MINI DIRT BUCKETS <b>NEW</b></p>  <p><b>168</b></p>
<p>MINI LIGHT MATERIAL BUCKETS <b>NEW</b></p>  <p><b>169</b></p>	<p>MINI ROCK BUCKETS</p>  <p><b>170</b></p>	<p>MINI 4-IN-1 BUCKETS</p>  <p><b>170</b></p>	<p>MINI DOZER BLADE</p>  <p><b>171</b></p>	<p>MINI BRUSH GRAPPLES <b>NEW</b></p>  <p><b>172</b></p>
<p>MINI ROOT GRAPPLES <b>NEW</b></p>  <p><b>172</b></p>	<p>MINI SCRAP GRAPPLES <b>NEW</b></p>  <p><b>173</b></p>	<p>MINI LEVELER</p>  <p><b>174</b></p>	<p>MINI POWER SHOVEL</p>  <p><b>174</b></p>	<p>MINI PALLET FORKS</p>  <p><b>175</b></p>
<p>MINI POWER BOX RAKE</p>  <p><b>175</b></p>	<p>MINI SKID/SWING HOES</p>  <p><b>176</b></p>	<p>MINI SNOW BLADE</p>  <p><b>176</b></p>	<p>MINI SNOW BLOWER</p>  <p><b>177</b></p>	<p>MINI STUMP GRINDER</p>  <p><b>178</b></p>

Note: All manufacturer's names, symbols, numbers and descriptions are used for reference purposes only and does not mean that any part is the product of these manufacturers or approved by these manufacturers.

# TABLE OF CONTENTS

<p>MINI TILLER</p>  <p><b>179</b></p>	<p>MINI TREE FORK</p>  <p><b>179</b></p>	<p>MINI TRENCHER</p>  <p><b>180</b></p>	<p>MINI VIBRATORY PLOW</p>  <p><b>182</b></p>	<p>MINI VIBRATORY ROLLER</p>  <p><b>183</b></p>
<p>MULCHERS - SERIES II FOR SKID-STEER LOADERS</p>  <p><b>186</b></p>	<p>MULCHERS - SERIES II FOR EXCAVATORS</p>  <p><b>191</b></p>	<p>FD60 FORESTRY DISK MULCHER</p>  <p><b>204</b></p>	<p>POST DRIVER</p>  <p><b>205</b></p>	<p>AUTORAKE</p>  <p><b>208</b></p>
<p>PERPARATOR</p>  <p><b>209</b></p>	<p>MX SERIES POWER RAKE <b>NEW</b></p>  <p><b>210</b></p>	<p>POWER BOX RAKE - 3 POINT</p>  <p><b>212</b></p>	<p>POWER BOX RAKE - DIRECT DRIVE</p>  <p><b>213</b></p>	<p>ROOT RAKE</p>  <p><b>215</b></p>
<p>ROCK SAW</p>  <p><b>218</b></p>	<p>SILAGE DEFACER</p>  <p><b>220</b></p>	<p>SKID/SWING HOE</p>  <p><b>221</b></p>	<p>ICESHARK SNOW BLOWERS</p>  <p><b>224</b></p>	<p>SNOW BLADES - 114 SERIES</p>  <p><b>226</b></p>
<p>SNOW BLADES - 115 SERIES</p>  <p><b>228</b></p>	<p>SNOW BLADES - 5700 SERIES</p>  <p><b>230</b></p>	<p>SNOW BLADES - 120 SERIES V-BLADE</p>  <p><b>232</b></p>	<p>SNOW BUCKETS</p>  <p><b>234</b></p>	<p>SNOW PUSH - 228 SERIES</p>  <p><b>235</b></p>
<p>SNOW PUSH - 232 SERIES</p>  <p><b>236</b></p>	<p>SNOW PUSH - 233 SERIES</p>  <p><b>238</b></p>	<p>COMPACT TRACTOR SNOW PUSH</p>  <p><b>240</b></p>	<p>COMPACT TRACTOR TRIP EDGE SNOW PUSH</p>  <p><b>241</b></p>	<p>STRIKEFORCE BREAKERS</p>  <p><b>244</b></p>
<p>STRIKEFORCE PLATE COMPACTORS</p>  <p><b>245</b></p>	<p>STUMP GRINDER</p>  <p><b>246</b></p>	<p>QCSS ANGLE SWEEPER</p>  <p><b>251</b></p>	<p>WLA ANGLE SWEEPER</p>  <p><b>254</b></p>	<p>LA ANGLE SWEEPER</p>  <p><b>256</b></p>















Note: All manufacturer's names, symbols, numbers and descriptions are used for reference purposes only and does not mean that any part is the product of these manufacturers or approved by these manufacturers.

# TABLE OF CONTENTS

<p>CTH ANGLE SWEEPER</p>  <p><b>258</b></p>	<p>CTM ANGLE SWEEPER</p>  <p><b>260</b></p>	<p>MRHL ANGLE SWEEPER</p>  <p><b>261</b></p>	<p>MRH ANGLE SWEEPER</p>  <p><b>264</b></p>	<p>RMRM ANGLE SWEEPER</p>  <p><b>266</b></p>
<p>RHFA ANGLE SWEEPER</p>  <p><b>267</b></p>	<p>RLH ANGLE SWEEPER</p>  <p><b>269</b></p>	<p>AH/CH ANGLE SWEEPER</p>  <p><b>272</b></p>	<p>QTCL ANGLE SWEEPER</p>  <p><b>275</b></p>	<p>SB HOPPER COLLECTOR SWEEPER</p>  <p><b>278</b></p>
<p>SB HOPPER COLLECTOR SWEEPER - HEAVY-DUTY</p>  <p><b>279</b></p>	<p>SB HOPPER COLD PLANER SPECIAL</p>  <p><b>281</b></p>	<p>VRS COLLECTOR SWEEPER</p>  <p><b>282</b></p>	<p>VS COLLECTOR SWEEPER</p>  <p><b>283</b></p>	<p>CS COLLECTOR SWEEPER</p>  <p><b>285</b></p>
<p>VCS COLLECTOR SWEEPER</p>  <p><b>287</b></p>	<p>REPLACEMENT BRUSHES</p>  <p><b>290</b></p>	<p>TILLERS</p>  <p><b>295</b></p>	<p>TREE FORKS</p>  <p><b>296</b></p>	<p>TREE SCOOP</p>  <p><b>296</b></p>
<p>TREE SPADE</p>  <p><b>297</b></p>	<p>TRENCHER MODEL 330</p>  <p><b>301</b></p>	<p>TRENCHER MODEL 612</p>  <p><b>303</b></p>	<p>TRENCHER MODEL 625</p>  <p><b>305</b></p>	<p>TRENCHER MODEL 640</p>  <p><b>310</b></p>
<p>VIBRATORY PLOW</p>  <p><b>312</b></p>	<p>VIBRATORY ROLLER</p>  <p><b>313</b></p>			

Note: All manufacturer's names, symbols, numbers and descriptions are used for reference purposes only and does not mean that any part is the product of these manufacturers or approved by these manufacturers.

## ICON KEY

	Ag Loader		Excavator		Telehandler
	Backhoe		Mini Excavator		Tractor
	Commercial Turf Mower		Wheel Loader		Truck
	Compact Tractor		Compact Tool Carrier		Walk Behind
	Skid-Steer		Compact Wheel Loader		

Add Surcharge to all products 8.85%

Note: All manufacturer's names, symbols, numbers and descriptions are used for reference purposes only and does not mean that any part is the product of these manufacturers or approved by these manufacturers.

# HOW TO ORDER AN ATTACHMENT

Since many of our attachments are customized to your needs, when you place your order you will need to choose your attachment, the mounting, and any options you would like. As you look through the products, notice the red headings in the charts - they will alert you to the choices you need to make.

Choose your attachment - be sure to check loader capacity before ordering

<b>BUCKET</b>		
<b>CHECK LOADER CAPACITY BEFORE ORDERING</b>		
	ORDER CODE	SHIP WEIGHT (LBS)
<b>(75 degree back)</b>		
73" OD Construction 4-in-1	LAF0976	1390
78" OD Construction 4-in-1	LAF0977	1475
82" OD Construction 4-in-1	LAF0985	1540
87" OD Construction 4-in-1	LAF0990	1620
<b>(Designed for Track Machines)</b>		
84" OD Construction 4-in-1 (70° back)	LAF0988	1343
90" OD Construction 4-in-1 (70° back)	LAF0992	1434

LIST PRICE of loader mounting must be added to the attachment LIST PRICE

Choose a mount

<b>MOUNTING</b>		
<b>ADDITIONAL COST MAY APPLY</b>		
	ORDER CODE	SHIP WEIGHT (LBS)
Contact Customer Service at (833) 723-1843		

Decide what options you want

<b>OPTIONS</b>		
<b>EXCLUSIVE TO FFC BUCKETS</b>		
	ORDER CODE	SHIP WEIGHT (LBS)
<b>Extra Heavy-Duty Toothbar for Buckets with Bolt-On Edge</b>		
For Bucket LAF0976 with 8 teeth	LAF9173-FF41	
For Bucket LAF0977 with 9 teeth	LAF9179-FF41	
For Bucket LAF0985 with 9 teeth	LAF9183-FF41	
For Bucket LAF0988	10640	
For Bucket LAF0992	10641	

The blue information bar will tell you what is included in the LIST PRICE and what you need to choose to order a complete attachment. It may also include other helpful information.



**INCLUDES: FLAIL MOWER ASSEMBLY. SHIPS WITHOUT HOSES AND COUPLERS DUE TO VARIATIONS BETWEEN MACHINES WITH REGARDS TO HYDRAULIC COUPLER PLACEMENT. TO ORDER :CHOOSE FLAIL MOWER ASSEMBLY AND MOUNT.**

The warning box contains important information pertaining to the attachment and prime mover and/or other safety information.



**IMPORTANT: FFC Skid-Steer buckets have a 70° angle on the back. This may increase or decrease the effective rollback and dump angles of your Skid-Steer. Specify Skid-Steer make and model when ordering.**



**IMPORTANT: Prime Movers with tracks and with an operating weight of 7,000 lbs. or more MUST have port reliefs installed on the prime mover's main control valve to protect both sides of the auxiliary circuit.**

If you have any questions about placing your order, contact Customer Service at (833) 723-1843.

Add Surcharge to all products 8.85%

# ADAPTERS



# ADAPTERS

## ADAPTER PLATES FOR SKID-STEER LOADERS



ADAPTERS

### DROP HEIGHT ADAPTER



- Clamps to existing skid-steer loader mounted attachments
- Lowers attachment by 2.38"
- Use with track over tire machines or oversized tires

DROP HEIGHT	ORDER CODE	SHIP WEIGHT (LBS)	LIST PRICE
drop height adapter	108953	50	\$1,213

### TILT ATTACH



- Attaches to skid-steer universal hitch to tilt 14° left and right
- Tilts buckets and landscaping implements for precise grading and leveling
- Trenchers can be tilted to cut a vertical trench

TILT ATTACH	ORDER CODE	SHIP WEIGHT (LBS)	LIST PRICE
tilt attach heavy-duty	17446	400	\$3,963
66" hose kit for standard & heavy duty models	103577	10	\$365
94" hose kit for standard & heavy duty models	103603	10	\$305
<b>Required to Operate Additional Hydraulic Attachments</b>			
universal valve package	88725	23	\$1,325

ADAPTER HARNESS FOR IN-CAB CONTROL (REQUIRES ONE OF THE BELOW) ONLY COMPATIBLE WITH VALVE PACKAGE	ORDER CODE	SHIP WEIGHT (LBS)	LIST PRICE
Control box w/ power lead	28-10754	5	\$383
7-pin for Bobcat	07-9548	5	\$985
Wire Harness (multi function in cab controls) for CNH, JCB, Bobcat, Mustang, Kubota, Takeuchi, Volvo 14 Pin-8 Pin	LAF9360-0000	5	\$268
14 pin - 8 pin for CAT XPS D	119740	5	\$770
14 pin - 8 pin for CAT XHP D	119741	5	\$784
8-pin, Fits F2-H Series, for CAT B and C	07-10170	5	\$553
8-pin for Komatsu	07-10057	5	\$585
14-pin, Fits All Series, for John Deere-8 button	LAF9361	5	\$362

## ADAPTER PLATES FOR SKID-STEER LOADERS CONT.

### UNIVERSAL MOUNT TO CATEGORY I OR II 3-POINT HITCH



- Attaches to skid-steer universal hitch for using 3-point hitch attachments

UNIVERSAL MOUNT TO CATEGORY I OR II 3-POINT HITCH	ORDER CODE	SHIP WEIGHT (LBS)	LIST PRICE
adapter plate	88020	210	\$1,443

### UNIVERSAL WELD-ON



- Welds to your implement to convert it to a universal hitch

UNIVERSAL WELD-ON ADAPTER	ORDER CODE	SHIP WEIGHT (LBS)	LIST PRICE
universal weld-on adapter	86914	75	\$379
heavy-duty universal weld-on adapter	88987	123	\$484

## ADAPTER PLATES FOR COMPACT TRACTORS



### COMPACT TRACTOR ADAPTER



COMPACT TRACTOR ADAPTER	ORDER CODE	SHIP WEIGHT (LBS)	LIST PRICE
attaches to tractor 3-point, category 1 & 2 for using Skid-Steer universal attachments	87640	137	\$1,725
attaches to skid-steer universal hitch for using 3-point hitch attachments	88020	210	\$1,443

### UNIVERSAL ADAPTER TO OEM HITCHES



UNIVERSAL ADAPTER TO OEM HITCHES	ORDER CODE	SHIP WEIGHT (LBS)	LIST PRICE
blank adapter (weld your own hitch)	12626	400	\$3,076
Cat IT/TH	12670	325	\$3,315
Ingersoll-Rand VR530 / VR642 (post-2002) / VR843 / 1044 / 1056	12492	359	\$3,076
JCB 506/508, Terex, Upright	11634	302	\$3,076
JCB Q-fit	13228	400	\$3,103
Manitou/New Holland LM5000 Series	17176	316	\$3,125
New Holland-Versattach	13228	400	\$3,103
SkyTrak/New Holland M400/Case TX Series	11634	302	\$3,076
Universal Adapter to QCP 7000	122689	530	\$4,826

# ADAPTERS

ADAPTERS

## ADAPTER PLATES FOR TRACTOR LOADERS/BACKHOES



### BLANK ADAPTER PLATE

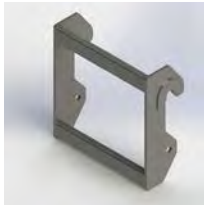

ADAPTER PLATE - BLANK	ORDER CODE	SHIP WEIGHT (LBS)	LIST PRICE
Cat IT/TH	12246	250	\$1,470
JCB 210S / 212S	12067	250	\$1,470
JCB Q-fit	12076	250	\$994
JCB Q-fit equipped 214/215/217 heavy duty	12325	300	\$1,383

## ADAPTER PLATES FOR TRACTOR LOADERS/BACKHOES AND WHEEL LOADERS



### BLANK ADAPTER PLATE



ADAPTER PLATE - BLANK	ORDER CODE	SHIP WEIGHT (LBS)	LIST PRICE
Cat IT/TH	12246	250	\$1,470
JCB 406/Volvo L25 ZL402	13107	184	\$916
JCB 407/409 BZ w/ Zettlemeyer ZL602	12068	400	\$1,383
JCB 411/416/426/436 Volvo L40-L 120 with HT coupler, ISO 23727	12072	400	\$2,161
John Deere 244J/304J/Volvo L30/L35/ZL602	12068	400	\$1,383
Komatsu WA75/WA85/WA95	12068	400	\$1,383
Wacker WL50	117106	94	POR

## ADAPTER PLATES FOR WHEEL LOADERS



### UNIVERSAL ADAPTER TO OEM HITCHES



UNIVERSAL ADAPTER TO OEM HITCHES	ORDER CODE	SHIP WEIGHT (LBS)	LIST PRICE
Universal Adapter, ISO 23727 / Zettlemeyer ZL802	13434	325	\$4,004
Universal Adapter, JRB 416	13465	398	\$4,205
blank adapter (weld your own hitch)	12626	400	\$3,076
Atlas / Coyote AR95	12760	245	POR
Atlas / Coyote AR45E, AR65, 55, 75, 85	12712	330	\$3,515
Cat IT/TH	12670	325	\$3,315
John Deere 304J - 244J ZL602	14820	400	\$2,598
Kawasaki 45ZV-2	119091	335	\$3,386
Komatsu WA65 ZL602	14820	400	\$2,598
Komatsu WA75 / 85 / 95 (this is a bolt-on plate that locks into the universal female and converts the unit to the host machine - stays with each attachment)	12532	245	POR
Komatsu WA75 / 85 / 95 & Zettlemeyer ZL602	14820	400	\$2,598
Takeuchi TW65	108869	345	\$3,794
TCM E804 / E806	12193	400	
Volvo L30-L35 ZL602	14820	400	\$2,598
Volvo ZL402 (this is a bolt-on plate that locks into the universal female and converts the unit to the host machine - stays with each attachment)	33670	245	POR

# AUGERS



# AUGERS

## PENGO CS SERIES AUGER DRIVES

**NEW PRODUCT**



- Advanced gearing as standard for increased life and efficiency
- Secure lock shaft
- Compact housing design for easy handling and increased strength and durability
- Oversized bearing for improved load handling
- Extreme shaft seals for reduced service intervals
- Compact, high torque, efficient hydraulic motors for improved drilling productivity
- Easy access service points for user friendly maintenance
- Full connection contact between auger hub and auger drive unit

	CS 11-12	CS 16-15	CS 20-17	CS 22-20	CS 28-22	CS 35-25
CARRIER WEIGHT MIN	1.8 K-LBS	2.2 K-LBS	4.4 K-LBS	5.5 K-LBS	6.6 K-LBS	6.6 K-LBS
CARRIER WEIGHT MAX	3.3 K-LBS	5.5 K-LBS	6.6 K-LBS	8.8 K-LBS	9.9 K-LBS	11.0 K-LBS
PRODUCT WEIGHT	130 LBS	130 LBS	130 LBS	156 LBS	156 LBS	158 LBS
OIL FLOW RATE MIN	5.3 GPM	6.6 GPM	9.2 GPM	9.2 GPM	10.6 GPM	10.6 GPM
OIL FLOW RATE MAX	11.9 GPM	14.5 GPM	17.2 GPM	19.8 GPM	22.5 GPM	25.1 GPM
OIL PRESSURE MIN	2031 PSI	2031 PSI	2031 PSI	2321 PSI	2321 PSI	2321 PSI
OIL PRESSURE MAX	3046 PSI	3481 PSI	3481 PSI	3771 PSI	3771 PSI	3771 PSI
ROTATIONAL SPEED MIN	45 RPM	45 RPM	51 RPM	48 RPM	44 RPM	35 RPM
ROTATIONAL SPEED MAX	101 RPM	98 RPM	94 RPM	103 RPM	93 RPM	83 RPM
OUTPUT TORQUE MIN	734 FT-LBS	918 FT-LBS	1138 FT-LBS	1362 FT-LBS	1716 FT-LBS	2149 FT-LBS
OUTPUT TORQUE MAX	1101 FT-LBS	1574 FT-LBS	1952 FT-LBS	2213 FT-LBS	2788 FT-LBS	3492 FT-LBS
CASE PRESSURE MAX	508 PSI	551 PSI	580 PSI	580 PSI	653 PSI	580 PSI
SHAFT TYPE	2 IN. HEX / 2.563 IN. ROUND	2 IN. HEX / 2.563 IN. ROUND	2 IN. HEX / 2.563 IN. ROUND	2 IN. HEX / 2.563 IN. ROUND	2 IN. HEX / 2.563 IN. ROUND	2 IN. HEX / 2.563 IN. ROUND

	CS 41-25	CS 38-30	CS 49-36	CS 39-37	CS 49-45	CS 62-48
CARRIER WEIGHT MIN	6.6 K-LBS	8.8 K-LBS	9.9 K-LBS	8.8 K-LBS	11.0 K-LBS	15.4 K-LBS
CARRIER WEIGHT MAX	12.1 K-LBS	13.2 K-LBS	15.4 K-LBS	13.2 K-LBS	17.6 K-LBS	22.0 K-LBS
PRODUCT WEIGHT	161 LBS	253 LBS	255 LBS	268 LBS	271 LBS	273 LBS
OIL FLOW RATE MIN	10.6 GPM	15.9 GPM	18.5 GPM	15.9 GPM	18.5 GPM	18.5 GPM
OIL FLOW RATE MAX	25.1 GPM	30.4 GPM	34.3 GPM	37.0 GPM	39.6 GPM	42.3 GPM
OIL PRESSURE MIN	2321 PSI	2321 PSI	2321 PSI	2321 PSI	2321 PSI	2031 PSI
OIL PRESSURE MAX	3771 PSI	3771 PSI	3771 PSI	3771 PSI	3771 PSI	3771 PSI
ROTATIONAL SPEED MIN	27 RPM	47 RPM	44 RPM	51 RPM	49 RPM	39 RPM
ROTATIONAL SPEED MAX	65 RPM	91 RPM	81 RPM	118 RPM	105 RPM	89 RPM
OUTPUT TORQUE MIN	2539 FT-LBS	2364 FT-LBS	3025 FT-LBS	2394 FT-LBS	3031 FT-LBS	3203 FT-LBS
OUTPUT TORQUE MAX	4125 FT-LBS	3841 FT-LBS	4916 FT-LBS	3890 FT-LBS	4925 FT-LBS	5948 FT-LBS
CASE PRESSURE MAX	580 PSI	580 PSI	580 PSI	319 PSI	406 PSI	566 PSI
SHAFT TYPE	2 IN. HEX / 2.563 IN. ROUND	2.5 IN. HEX	2.5 IN. HEX	2.5 IN. HEX	2.5 IN. HEX	2.5 IN. HEX

CS AUGER DRIVES CONTINUED NEXT PAGE

## PENGO CS SERIES AUGER DRIVES CONT.

CS SERIES AUGER DRIVES FOR COMPACT TOOL CARRIERS, TRACTORS, TELEHANDLERS, BACKHOE LOADERS, SKID-STEER LOADERS, MINI EXCAVATORS, AND EXCAVATORS



**INCLUDES: AUGER DRIVE, HOSES, AND PIN.**  
**YOU MUST ORDER MOUNTING KIT, FLUSH FACE COUPLERS, AUGER BITS, EXTENSIONS SEPARATELY**

CS SERIES AUGER DRIVES Hose routed out the side	ORDER CODE	SHIP WEIGHT (LBS)	LIST PRICE
CS 11-12 2.56" Round Auger Drive, 0.8 - 2 MT	810231N	130	\$2,190
CS 11-12 2" Hex Auger Drive, 0.8 - 2 MT	810232N	130	\$2,190
CS 16-15 2.56" Round Auger Drive, 1 - 2.5 MT	810237N	130	\$2,190
CS 16-15 2" Hex Auger Drive, 1 - 2.5 MT	810238N	130	\$3,125
CS 20-17 2.56" Round Auger Drive, 2 - 3 MT	810243N	130	\$3,195
CS 20-17 2" Hex Auger Drive, 2 - 3 MT	810244N	130	\$3,195
CS 22-20 2.56" Round Auger Drive, 2.5 - 4 MT	810330N	156	\$2,328
CS 22-20 2" Hex Auger Drive, 2.5 - 4 MT	810331N	156	\$2,328
CS 28-22 2.56" Round Auger Drive, 3 - 4.5 MT	810335N	156	\$2,450
CS 28-22 2" Hex Auger Drive, 3 - 4.5 MT	810336N	156	\$2,450
CS 35-25 2.56" Round Auger Drive, 3.5 - 5 MT	810340N	158	\$2,790
CS 35-25 2" Hex Auger Drive, 3.5 - 5 MT	810341N	158	\$2,790
CS 41-25 2.56" Round Auger Drive, 4 - 6 MT	810345N	161	\$3,190
CS 41-25 2" Hex Auger Drive, 4 - 6 MT	810346N	161	\$3,190
CS 38-30 2.5" Hex Auger Drive, 4 - 6 MT	810395N	253	\$3,560
CS 49-36 2.5" Hex Auger Drive, 4.5 - 7 MT	810398N	255	\$6,190
CS 39-37 2.5" Hex Auger Drive, 4.5 - 7 MT	810404N	268	\$6,190
CS 49-45 2.5" Hex Auger Drive, 5 - 8 MT	810407N	271	\$6,380
CS 62-48 2.5" Hex Auger Drive, 7 - 10 MT	810410N	273	\$6,380

\*To mount CS drives to existing McMillen mounts, you must order swivel part number 810098N

Add Surchage to all Products 8.85%

# AUGERS

## PENGO CS SERIES KITTED BUNDLES



INCLUDES: MOUNT, DRIVE, AND SELECT BUNDLES INCLUDE QUICK DISCONNECT FITTINGS. SEE TABLE FOR PROPER OUTPUT SHAFT AND DETAILS.



### CS SERIES KITTED BUNDLES FOR SKID STEER LOADERS

SKID STEER MOUNT BUNDLES						
Hose routed out the side						
ORDER CODE	DESCRIPTION	OUTPUT SHAFT	MOUNT	QD INCLUDED	SHIP WEIGHT (LBS)	LIST PRICE
810237N-0022	CS 16-15 AUGER DRIVE	2.563 IN ROUND	Universal SSL	1/2	277	\$3,125
810238N-0022	CS 16-15 AUGER DRIVE	2 IN HEX	Universal SSL	1/2	277	\$3,125
810335N-0022	CS 28-22 AUGER DRIVE	2.563 IN ROUND	Universal SSL	1/2	305	\$3,385
810336N-0022	CS 28-22 AUGER DRIVE	2 IN HEX	Universal SSL	1/2	305	\$3,385
810340N-0022	CS 35-25 AUGER DRIVE	2.563 IN ROUND	Universal SSL	1/2	305	\$3,725
810341N-0022	CS 35-25 AUGER DRIVE	2 IN HEX	Universal SSL	1/2	305	\$3,725
810345N-0022	CS 41-25 AUGER DRIVE	2.563 IN ROUND	Universal SSL	1/2	307	\$4,125
810346N-0022	CS 41-25 AUGER DRIVE	2 IN HEX	Universal SSL	1/2	307	\$4,125
810410N-9925	CS 62-48 AUGER DRIVE	2.5 IN HEX	Universal SSL	3/4	433	\$7,499

### CS SERIES KITTED BUNDLES FOR QUICK CHANGE BETWEEN SKID STEERS AND EXCAVATORS



EXCAVATOR AND SKID STEER C&P 027 TO SKID STEER QUICK CHANGE MOUNT BUNDLES						
Hose routed out the side						
ORDER CODE	DESCRIPTION	OUTPUT SHAFT	MOUNT	SHIP WEIGHT (LBS)	LIST PRICE	
810335N-E0852-0022	CS 28-22 AUGER DRIVE	2.563 IN ROUND	C&P 027	635	\$4,855	
810336N-E0852-0022	CS 28-22 AUGER DRIVE	2 IN HEX	C&P 027	633	\$4,855	
810340N-E0852-0022	CS 35-25 AUGER DRIVE	2.563 IN ROUND	C&P 027	633	\$5,195	
810341N-E0852-0022	CS 35-25 AUGER DRIVE	2 IN HEX	C&P 027	633	\$5,195	
810345N-E0852-0022	CS 41-25 AUGER DRIVE	2.563 IN ROUND	C&P 027	635	\$5,595	
810346N-E0852-0022	CS 41-25 AUGER DRIVE	2 IN HEX	C&P 027	635	\$5,595	

### CS SERIES KITTED BUNDLES FOR EXCAVATORS

EXCAVATOR MOUNT BUNDLES						
Hose routed out the side						
ORDER CODE	DESCRIPTION	OUTPUT SHAFT	MOUNT	SHIP WEIGHT (LBS)	LIST PRICE	
810335N-E0852	CS 28-22 AUGER DRIVE	2.563 IN ROUND	C&P 027	278	\$3,417	
810336N-E0852	CS 28-22 AUGER DRIVE	2 IN HEX	C&P 027	276	\$3,417	
810340N-E0852	CS 35-25 AUGER DRIVE	2.563 IN ROUND	C&P 027	276	\$3,757	
810341N-E0852	CS 35-25 AUGER DRIVE	2 IN HEX	C&P 027	276	\$3,757	
810345N-E0852	CS 41-25 AUGER DRIVE	2.563 IN ROUND	C&P 027	278	\$4,157	
810346N-E0852	CS 41-25 AUGER DRIVE	2 IN HEX	C&P 027	278	\$4,157	
810335N-E0333	CS 28-22 AUGER DRIVE	2.563 IN ROUND	C&P 030	400	\$4,640	
810336N-E0333	CS 28-22 AUGER DRIVE	2 IN HEX	C&P 030	398	\$4,640	
810340N-E0333	CS 35-25 AUGER DRIVE	2.563 IN ROUND	C&P 030	398	\$4,980	
810341N-E0333	CS 35-25 AUGER DRIVE	2 IN HEX	C&P 030	398	\$4,980	
810345N-E0333	CS 41-25 AUGER DRIVE	2.563 IN ROUND	C&P 030	400	\$5,380	
810346N-E0333	CS 41-25 AUGER DRIVE	2 IN HEX	C&P 030	400	\$5,380	



## PENGO CS SERIES AUGER DRIVES - MOUNTS

**Quick Attach Mount**



**Double Pin Mount**



**Universal Mount**



**SSL Mount**



CS SERIES AUGERS	ORDER CODE	SHIP WEIGHT (LBS)	LIST PRICE
<b>Quick Attach Mount</b>			
C&P 027 COUPLER, CRADLE-READY	239261	101	\$967
C&P 030 COUPLER, CRADLE-READY	239262	233	\$2,190
KUBOTA KX41-3/U15, U17, KX018-4, K7966, CRADLE NOT AVAILABLE	239263	79	\$725
KUBOTA KX040, KX71-3, KX91-3, KX121-3, U35, KX033-K7870, CRADLE-READY	239264	117	\$725
KUBOTA KX057, U55, USA ONLY K7915, CRADLE-READY	239265	140	\$725
KUBOTA KX161-3, U45, K9940, CRADLE NOT AVAILABLE	239266	121	\$725
KUBOTA KX080 MINI EXCAVATOR K7402, CRADLE-READY	239267	169	\$725
JD 27D ZTS/35D ZTS MINI EXCAVATOR, CRADLE NOT AVAILABLE	239268	96	\$725
JOHN DEERE WEDGE-STYLE COUPLER WITH 9" EAR SPACING, INCLUDES CRADLE	239257	127	\$938
BOBCAT XCHANGE QA	239282	40	\$2,648
<b>Double Pin Mount</b>			
PIN GRAB, YANMAR VIO27/VIO35, CRADLE NOT AVAILABLE	239270	73	\$1,075
PIN GRAB, CAT 303.5, 303, 304, DX35Z, CX37C, R35Z, CRADLE-READY	239271	116	\$1,075
PIN GRAB, YANMAR VIO45/55/40/50, CX60, CRADLE NOT AVAILABLE	239272	112	\$1,075
PIN GRAB, HYUNDAI R60CR-9 / CASE CX57C, CX60C, CRADLE-READY	239273	182	\$1,075
PIN GRAB, CAT 305/305.5 / DOOSAN DX62, CRADLE-READY	239274	139	\$1,075
PIN GRAB, YANMAR VIO75/B7/SV100, KOM PC78, JD 75G85G, CRADLE NOT AVAILABLE	239275	138	\$1,075
<b>Universal Mounts</b>			
WELD ON PLATE W/SWIVEL LINK, NO CRADLE	239276	82	\$332
BOLT ON PLATE W/SWIVEL LINK	239277	82	\$377
<b>SSL Mount</b>			
SSL MOUNT OFFSET, WITH CRADLE	239278	159	\$600
SSL MOUNT WITH CRADLE	239279	150	\$800
SSL TO C&P 027 ADAPTER (AUGER DRIVE REQUIRED TO HAVE 239261 COUPLER)	13-18456	357	\$2,545
<b>Add on Parts</b>			
BOLT-ON CRADLE FOR CRADLE-READY MOUNTS	21670	15.5	\$134
CS SWIVEL - ADAPTOR FOR MCMILLEN MOUNTS	810098N	11	\$106

# AUGERS

AUGERS

## PENGO AUGER DRIVES DT-5 DRILLING 2-SPEED PLANETARY DRIVE



- Removable Top Section
- Standard cross-over pressure relief system that is designed to protect the motor from pressure spikes and potential overload conditions
- Attached Manual Holder for Quick Access
- Highly Efficient Gearbox designed for long duty cycles
- 2 1/2" Hex Output Shaft

Hydraulic Motor Information	
Displacement	2.98 cu/in (97.6cc)
Motor Type	Two Speed Bi-Directional
Motor Output Shaft	1 1/4" Spline 14T
Motor Mount	SAE - C 4 Bolt
Motor Ports	1 5/8" - 12 UN-2B
Cross Over Pressure Relief	Set at 3,100 psi

Planetary Gearbox Information	
Gearbox Type	Planetary Two Stage
Reduction Ratio	25.36:1
Output Shaft	2 1/2" Hex
Internal Oil Capacity	2.0 Gallons
Oil Type	SAE 80W90 GL-5
Shaft Pull Out (lbs.)	22,500 lbs.

Output Speed			Output Torque (LT/HS)			Output Torque (HT/LS)		
Flow	LOW	HIGH	PRESSURE	THEORETICAL	ACTUAL	PRESSURE	THEORETICAL	ACTUAL
20 GPM	25 RPM	50 RPM	1000 PSI	1002 FT/LB	822 FT/LB	1000 PSI	2004 FT/LB	1643 FT/LB
25 GPM	31 RPM	63 RPM	1200 PSI	1202 FT/LB	986 FT/LB	1200 PSI	2404 FT/LB	1971 FT/LB
30 GPM	38 RPM	75 RPM	1400 PSI	1402 FT/LB	1150 FT/LB	1400 PSI	2805 FT/LB	2300 FT/LB
35 GPM	44 RPM	88 RPM	1600 PSI	1603 FT/LB	1314 FT/LB	1600 PSI	3206 FT/LB	2629 FT/LB
40 GPM	50 RPM	100 RPM	1800 PSI	1803 FT/LB	1478 FT/LB	1800 PSI	3607 FT/LB	2958 FT/LB
			2000 PSI	2004 FT/LB	1643 FT/LB	2000 PSI	4008 FT/LB	3287 FT/LB
			2200 PSI	2204 FT/LB	1807 FT/LB	2200 PSI	4409 FT/LB	3615 FT/LB
			2400 PSI	2404 FT/LB	1971 FT/LB	2400 PSI	4809 FT/LB	3943 FT/LB
			2600 PSI	2605 FT/LB	2136 FT/LB	2600 PSI	5210 FT/LB	4272 FT/LB
			2800 PSI	2805 FT/LB	2300 FT/LB	2800 PSI	5611 FT/LB	4601 FT/LB
			3000 PSI	3006 FT/LB	2465 FT/LB	3000 PSI	6012 FT/LB	4930 FT/LB

Note that both theoretical and actual torque values are listed, but that Pengo recommends to go by ACTUAL torque listings.

## DT-5 DRILLING AUGER DRIVE FOR SKID-STEER LOADERS AND 3T-6T MINI EXCAVATORS



**INCLUDES: AUGER DRIVE ONLY. YOU MUST ORDER MOUNTING KIT, AUGER BITS, AND EXTENSIONS SEPARATELY.**

DT-5 DRILLING AUGER DRIVE	ORDER CODE	SHIP WEIGHT (LBS)	LIST PRICE
DT-5 2.5" Hex Auger Drive 20-40 GPM	610173	645	\$14,971

## PENGO AUGER DRIVES DT-15 DRILLING 2-SPEED PLANETARY DRIVE



- Removable Top Section
- Standard cross-over pressure relief system that is designed to protect the motor from pressure spikes and potential overload conditions
- Attached Manual Holder for Quick Access
- Highly Efficient Gearbox designed for long duty cycles
- 3" Hex Output Shaft

Hydraulic Motor Information	
Displacement	17.8 cu/in (293cc)
Motor Type	Two Speed Bi-Directional
Motor Output Shaft	1 1/4" Spline 14T
Motor Mount	SAE - C 4 Bolt
Motor Ports	1 5/8" - 12 UN-2B
Cross Over Pressure Relief	Set at 3,100 psi

Planetary Gearbox Information	
Gearbox Type	Planetary Two Stage
Reduction Ratio	26.52:1
Output Shaft	3" Hex
Internal Oil Capacity	3.0 Gallons
Oil Type	SAE 80W90 GL-5
Shaft Pull Out (lbs.)	22,500 lbs.

Output Speed		
Flow	LOW	HIGH
20 GPM	8 RPM	16 RPM
30 GPM	12 RPM	24 RPM
40 GPM	16 RPM	32 RPM
50 GPM	20 RPM	40 RPM

Output Torque (LT/HS)		
PRESSURE	THEORETICAL	ACTUAL
1000 PSI	3145 FT/LB	2579 FT/LB
1200 PSI	3775 FT/LB	3096 FT/LB
1400 PSI	4404 FT/LB	3611 FT/LB
1600 PSI	5033 FT/LB	4127 FT/LB
1800 PSI	5662 FT/LB	4643 FT/LB
2000 PSI	6291 FT/LB	5159 FT/LB
2200 PSI	6920 FT/LB	5674 FT/LB
2400 PSI	7550 FT/LB	6191 FT/LB
2600 PSI	8179 FT/LB	6707 FT/LB
2800 PSI	8808 FT/LB	7223 FT/LB
3000 PSI	9437 FT/LB	7738 FT/LB

Output Torque (HT/LS)		
PRESSURE	THEORETICAL	ACTUAL
1000 PSI	6291 FT/LB	5159 FT/LB
1200 PSI	7550 FT/LB	6191 FT/LB
1400 PSI	8808 FT/LB	7223 FT/LB
1600 PSI	10066 FT/LB	8254 FT/LB
1800 PSI	11325 FT/LB	9287 FT/LB
2000 PSI	12583 FT/LB	10318 FT/LB
2200 PSI	13841 FT/LB	11350 FT/LB
2400 PSI	15100 FT/LB	12382 FT/LB
2600 PSI	16358 FT/LB	13414 FT/LB
2800 PSI	17616 FT/LB	14445 FT/LB
3000 PSI	18875 FT/LB	15478 FT/LB

Note that both theoretical and actual torque values are listed, but that Pengo recommends to go by ACTUAL torque listings.

## DT-15 DRILLING AUGER DRIVE FOR 12T-20T EXCAVATORS



**INCLUDES: AUGER DRIVE ONLY. YOU MUST ORDER MOUNTING KIT, AUGER BITS, AND EXTENSIONS SEPARATELY.**

DT-15 DRILLING AUGER DRIVE	ORDER CODE	LIST PRICE
DT-15 3" Hex Auger Drive 20-50 GPM	610174	\$19,670

# AUGERS

## PENGO AUGER DRIVES

### DV-20 DRILLING VARIABLE SPEED PLANETARY DRIVE



- Removable Top Section
- Motor equipped with Quick Coupler
- Powerful and efficient motor
- Attached Manual Holder for Quick Access
- Highly Efficient Gearbox designed for long duty cycles
- 3" Hex Output Shaft

Hydraulic Motor Information	
Displacement	8.25 cu/in (135cc)
Motor Type	Variable Speed Bi-Directional
Motor Output Shaft	8/16" Spline 13T
Motor Mount	SAE - D 2 Bolt
Motor Ports	Code 62 SAE Split Flange
Cross Over Pressure Relief	None

Planetary Gearbox Information	
Gearbox Type	Planetary Three Stage
Reduction Ratio	60.56:1
Output Shaft	3" Hex
Internal Oil Capacity	3.0 Gallons
Oil Type	SAE 80W90 GL-5
Shaft Pull Out (lbs.)	45,000 lbs.

Output Speed			Output Torque (LT/HS)			Output Torque (HT/LS)		
Flow	LOW	HIGH	PRESSURE	THEORETICAL	ACTUAL	PRESSURE	THEORETICAL	ACTUAL
40 GPM	16 RPM	27 RPM	2000 PSI	7845 FT/LB	6668 FT/LB	2000 PSI	13239 FT/LB	11253 FT/LB
45 GPM	18 RPM	30 RPM	2200 PSI	8630 FT/LB	7336 FT/LB	2200 PSI	14563 FT/LB	12379 FT/LB
50 GPM	20 RPM	33 RPM	2400 PSI	9414 FT/LB	8002 FT/LB	2400 PSI	15887 FT/LB	13504 FT/LB
55 GPM	22 RPM	37 RPM	2600 PSI	10199 FT/LB	8669 FT/LB	2600 PSI	17211 FT/LB	14629 FT/LB
60 GPM	24 RPM	40 RPM	2800 PSI	10984 FT/LB	9336 FT/LB	2800 PSI	18535 FT/LB	15755 FT/LB
			3000 PSI	11768 FT/LB	10003 FT/LB	3000 PSI	19859 FT/LB	16880 FT/LB
			3200 PSI	12553 FT/LB	10670 FT/LB	3200 PSI	21183 FT/LB	18006 FT/LB
			3400 PSI	13337 FT/LB	11336 FT/LB	3400 PSI	22507 FT/LB	19131 FT/LB
			3600 PSI	14122 FT/LB	12004 FT/LB	3600 PSI	23831 FT/LB	20256 FT/LB
			3800 PSI	14907 FT/LB	12671 FT/LB	3800 PSI	25155 FT/LB	21382 FT/LB
			4000 PSI	15691 FT/LB	13337 FT/LB	4000 PSI	26479 FT/LB	22507 FT/LB

Note that both theoretical and actual torque values are listed, but that Pengo recommends to go by ACTUAL torque listings.

### DV-20 DRILLING AUGER DRIVE FOR 12T-20T EXCAVATORS



**INCLUDES: AUGER DRIVE ONLY. YOU MUST ORDER MOUNTING KIT, AUGER BITS, AND EXTENSIONS SEPARATELY.**

DV-20 DRILLING AUGER DRIVE	ORDER CODE	SHIP WEIGHT (LBS)	LIST PRICE
DV-20 3" Hex Auger Drive 40-60 GPM	610442	880	\$32,381

## PENGO AUGER DRIVES DV-30 DRILLING VARIABLE SPEED PLANETARY DRIVE



- Removable Top Section
- Motor equipped with Quick Coupler
- Powerful and efficient motor
- Attached Manual Holder for Quick Access
- Highly Efficient Gearbox designed for long duty cycles
- 4" Square Output Shaft

Hydraulic Motor Information	
Displacement	10.06 cu/in (165cc)
Motor Type	Variable Speed Bi-Directional
Motor Output Shaft	8/16" Spline 13T
Motor Mount	SAE - D 2 Bolt
Motor Ports	Code 62 SAE Split Flange
Cross Over Pressure Relief	None

Planetary Gearbox Information	
Gearbox Type	Planetary Three Stage
Reduction Ratio	69.7:1
Output Shaft	4" Square
Internal Oil Capacity	3.17 Gallons
Oil Type	SAE 80W90 GL-5
Shaft Pull Out (lbs.)	60,000 lbs.

Output Speed		
Flow	LOW	HIGH
40 GPM	11 RPM	27 RPM
45 GPM	13 RPM	31 RPM
50 GPM	14 RPM	34 RPM
55 GPM	15 RPM	37 RPM
60 GPM	17 RPM	41 RPM

Output Torque (LT/HS)		
PRESSURE	THEORETICAL	ACTUAL
2000 PSI	7675 FT/LB	6524 FT/LB
2200 PSI	8442 FT/LB	7176 FT/LB
2400 PSI	9210 FT/LB	7829 FT/LB
2600 PSI	9978 FT/LB	8481 FT/LB
2800 PSI	10745 FT/LB	9133 FT/LB
3000 PSI	11513 FT/LB	9786 FT/LB
3200 PSI	12280 FT/LB	10438 FT/LB
3400 PSI	13048 FT/LB	11091 FT/LB
3600 PSI	13815 FT/LB	11743 FT/LB
3800 PSI	14583 FT/LB	12396 FT/LB
4000 PSI	15350 FT/LB	13048 FT/LB

Output Torque (HT/LS)		
PRESSURE	THEORETICAL	ACTUAL
2000 PSI	18624 FT/LB	15830 FT/LB
2200 PSI	20486 FT/LB	17413 FT/LB
2400 PSI	22349 FT/LB	18997 FT/LB
2600 PSI	24211 FT/LB	20579 FT/LB
2800 PSI	26073 FT/LB	22162 FT/LB
3000 PSI	27936 FT/LB	23746 FT/LB
3200 PSI	29798 FT/LB	25328 FT/LB
3400 PSI	31661 FT/LB	26912 FT/LB
3600 PSI	33523 FT/LB	28495 FT/LB
3800 PSI	35386 FT/LB	30078 FT/LB
4000 PSI	37248 FT/LB	31661 FT/LB

Note that both theoretical and actual torque values are listed, but that Pengo recommends to go by ACTUAL torque listings.

### DV-30 DRILLING AUGER DRIVE FOR 15T-25T EXCAVATORS



**INCLUDES: AUGER DRIVE ONLY. YOU MUST ORDER MOUNTING KIT, AUGER BITS, AND EXTENSIONS SEPARATELY.**

DV-30 DRILLING AUGER DRIVE	ORDER CODE	SHIP WEIGHT (LBS)	LIST PRICE
DV-30 4" Square Auger Drive 40-60 GPM	610384	1250	\$39,899

# AUGERS

## PENGO AUGER DRIVES

### DV-40 DRILLING VARIABLE SPEED PLANETARY DRIVE



- Removable Top Section
- Motor equipped with Quick Coupler
- Powerful and efficient motor
- Attached Manual Holder for Quick Access
- Highly Efficient Gearbox designed for long duty cycles
- 130mm Square Output Shaft

Hydraulic Motor Information	
Displacement	10.06 cu/in (165cc)
Motor Type	Variable Speed Bi-Directional
Motor Output Shaft	8/16" Spline 13T
Motor Mount	SAE - D 2 Bolt
Motor Ports	Code 62 SAE Split Flange
Cross Over Pressure Relief	None

Planetary Gearbox Information	
Gearbox Type	Planetary Three Stage
Reduction Ratio	83.78:1
Output Shaft	130mm Square
Internal Oil Capacity	4.0 Gallons
Oil Type	SAE 80W90 GL-5
Shaft Pull Out (lbs.)	60,000 lbs.

Output Speed			Output Torque (LT/HS)			Output Torque (HT/LS)		
Flow	LOW	HIGH	PRESSURE	THEORETICAL	ACTUAL	PRESSURE	THEORETICAL	ACTUAL
40 GPM	9 RPM	23 RPM	2000 PSI	9225 FT/LB	7841 FT/LB	2000 PSI	22386 FT/LB	19028 FT/LB
45 GPM	10 RPM	25 RPM	2200 PSI	10148 FT/LB	8626 FT/LB	2200 PSI	24625 FT/LB	20931 FT/LB
50 GPM	12 RPM	28 RPM	2400 PSI	11071 FT/LB	9410 FT/LB	2400 PSI	26863 FT/LB	22834 FT/LB
55 GPM	13 RPM	31 RPM	2600 PSI	11993 FT/LB	10194 FT/LB	2600 PSI	29102 FT/LB	24737 FT/LB
60 GPM	14 RPM	34 RPM	2800 PSI	12916 FT/LB	10979 FT/LB	2800 PSI	31341 FT/LB	26640 FT/LB
			3000 PSI	13838 FT/LB	11762 FT/LB	3000 PSI	33579 FT/LB	28542 FT/LB
			3200 PSI	14761 FT/LB	12547 FT/LB	3200 PSI	35818 FT/LB	30445 FT/LB
			3400 PSI	15684 FT/LB	13331 FT/LB	3400 PSI	38057 FT/LB	32348 FT/LB
			3600 PSI	16606 FT/LB	14115 FT/LB	3600 PSI	40295 FT/LB	34251 FT/LB
			3800 PSI	17529 FT/LB	14900 FT/LB	3800 PSI	42534 FT/LB	36154 FT/LB
			4000 PSI	18451 FT/LB	15683 FT/LB	4000 PSI	44772 FT/LB	38056 FT/LB

Note that both theoretical and actual torque values are listed, but that Pengo recommends to go by ACTUAL torque listings.

### DV-40 DRILLING AUGER DRIVE FOR 15T-25T EXCAVATORS



**INCLUDES: AUGER DRIVE ONLY. YOU MUST ORDER MOUNTING KIT, AUGER BITS, AND EXTENSIONS SEPARATELY.**

DV-40 DRILLING AUGER DRIVE	ORDER CODE	SHIP WEIGHT (LBS)	LIST PRICE
DV-40 130MM Square Auger Drive 40-60 GPM	610385	1500	\$43,370

## AUGER DRIVES

PENGO AUGER DRIVE ACCESSORIES	ORDER CODE	SHIP WEIGHT (LBS)	LIST PRICE
Pin Assembly 45mm w/ retainers	660558		\$95
Link Arm 45mm Series	660555		\$1,225
Adapter Drive Tool, H-250 paint	158132		\$364
Adapter Drive Tool, H-300 paint	158137		\$391
Pin 75mm x 10.13	660554		\$294
Link Arm, Painted 7" round 75mm pin	610202		\$2,884
Adapter Drive Tool, S-130mm paint	610301		\$1,935

Add Surcharge to all products 8.85%

## PENGO AUGER MOUNTING KITS AND COMPONENTS



ALL MOUNTS ARE ORGANIZED BY PRIME MOVER AND STYLE (PENDULUM/DIPPER, DIRECT PIN-ON/PIN-GRABBER, OR QUICK ATTACH) MOUNTS ARE ALSO CHARACTERIZED BY CRADLE TYPE

### QUICK ATTACH MOUNTING BRACKETS



NOTE: IF YOUR MOUNT IS NOT LISTED CALL (833) 723-1843

#### PENGO AUGER MODELS DV30, DV40, RT30, RT40 - 75MM

	ORDER CODE	SHIP WEIGHT (LBS)	LIST PRICE
<b>Dedicated Quick Attach Mount</b>			
Komatsu PC 200 TALL	661840		\$6,050
Bobcat E35	661862		\$2,932
Bobcat E85 NO PINS	662067		POR
Case CX-350	662044		\$6,050
Case CX 145	661773		\$4,826
Case CX-240	661200		\$6,050
Case CX-80	661528		\$4,186
Case-210	661844		\$4,010
CAT 303.5E	662074		\$6,050
CAT 303CR	661194		\$3,489
CAT 305.5	661856		\$3,822
CAT 307C	662102		\$6,274
CAT 312	660912		\$3,512
CAT 315-C	661104		\$4,003
CAT 320/322-B	660953		\$3,886
CAT 320	661828		POR
CAT 320D SPEC	662138		\$3,513
CAT 329	661690		\$2,969
CAT 330 L	662124		\$7,302
CAT 336-E	661398		\$8,855
CAT 420-F	661662		\$4,532
CAT-308	661520		\$3,743
CAT 302.5	661849		POR
CAT 320/321 TALL	661350		\$6,050
CAT 320 QC [WIDE]	662082		\$6,050
CAT M322D	662386		\$6,050
CAT 329EL	661834		\$6,050
CAT 330-C	661147		\$6,050
CAT 330 SPEC	662382		\$6,050
CAT 345-F	661550		\$6,050
CAT 4446 BACKHOE	661424		\$6,050
Doosan DX-140	662055		\$3,311
Esco QCK CPLR	660926		

MOUNTING BRACKETS FOR EXCAVATORS CONTINUED NEXT PAGE

## PENGO AUGER MOUNTING KITS AND COMPONENTS

### QUICK ATTACH MOUNTING BRACKETS

PENGO AUGER MODELS DV30, DV40, RT30, RT40 - 75MM	ORDER CODE	SHIP WEIGHT (LBS)	LIST PRICE
<b>Dedicated Quick Attach Mount</b>			
Hitachi ZX245LC	661911		\$4,283
Hitachi 200-3 PNT	661296		\$6,050
Hitachi ZX-450	661451		POR
Hyundai R290LC-9ALR	661932		\$6,050
International 35NX	661779		POR
John Deere 410 BACK HOE	661360		\$4,940
John Deere 350	661352		\$7,065
John Deere 160LC	661107		\$3,762
John Deere 2905	661650		\$6,050
John Deere 350	661276		\$10,267
John Deere 85D	661241		\$3,575
John Deere 85G JR20MPL	662153		\$3,809
John Deere 245,200	661093		\$4,440
John Deere 245 G LC	662321		\$8,724
John Deere 135G	662351		\$2,530
John Deere 270D	661255		\$6,050
John Deere 290 GLC 790 DE	661661		\$6,050
John Deere 470	661580		\$6,050
Kobelco SK 115, 130 & 135	660960		\$6,050
Komatsu PC 200-308	661387		\$7,658
Komatsu PC100 THRU 158	660933		\$3,457
Komatsu PC-228	662149		\$7,405
Komatsu PC 210	662360		\$4,010
Komatsu PC 170	662366		\$3,936
Kobelco SK-160	661445		\$6,050
Komatsu PC-228 TALL	661799		\$6,050
Komatsu PC-240	661748		\$2,060
Komatsu PC-300	661223		\$6,050
Komatsu PC360	661803		\$6,890
Komatsu PC360	662343		\$6,050
Komatsu PC-50	661025		\$6,050
Link Belt 160-X2	661442		\$6,050
Rotoloc 45/55	660927		\$6,050
Sany 335	661903		\$6,050
Solar 175	661204		POR
Takeuchi TB-1140	661820		\$4,468
Takeuchi TB-145	661620		\$6,050
Volvo EC240	661616		\$3,275
Volvo EC-160	661734		\$5,210
Wacker Neuson E 125	662123		\$6,050
Yanmar VIO35	661428		\$3,582
Yanmar SV-100	661210		\$6,050

# AUGERS

## PENGO AUGER MOUNTING KITS AND COMPONENTS



ALL MOUNTS ARE ORGANIZED BY PRIME MOVER AND STYLE (PENDULUM/DIPPER, DIRECT PIN-ON/PIN-GRABBER, OR QUICK ATTACH) MOUNTS ARE ALSO CHARACTERIZED BY CRADLE TYPE

### END OF STICK MOUNTING BRACKETS



NOTE: IF YOUR MOUNT IS NOT LISTED CALL (833) 723-1843

#### PENGO AUGER MODELS DT-5, DT-15, DV-20 - 45MM

	ORDER CODE	SHIP WEIGHT (LBS)	LIST PRICE
<b>End of Stick Mount</b>			
Bobcat E85	662071		\$2,060
Bobcat 331 MINI EX]	661203		\$2,107
Bobcat Skid Steer	662007		\$2,060
Bobcat 709-8709	661609		\$2,060
Case 580M	661461		\$1,708
Case CX-160	661338		\$1,915
Case 210	662043		\$2,060
Case CX75	661867		\$2,107
Case CX-135	661254		\$2,107
CAT 308	661873		\$1,692
CAT 320 DV-30 / 40	661564		\$2,968
CAT 312	661340		\$2,107
CAT 329	661696		\$2,653
CAT 320/322-B	661331		\$1,943
CAT 308	662064		\$2,107
CAT 320C	661826		POR
CAT 320 DV-30 / 40	661766		\$2,060
CAT 336	661686		\$2,107
CAT 420	661649		\$2,107
CAT 325	661629		\$2,060
CAT 420	661470		\$2,107
CAT 420	661405		\$2,107
CAT 315	661337		\$2,107
CAT 426C	661332		\$2,107
CAT 318	661303		\$2,060
CAT 330-B	661300		\$2,107
CAT 311	661236		\$2,107
CAT 325-B	661235		\$2,107
Daewoo S175V	661220		\$2,060
Doosan 225DX	661853		\$2,060
Eskridge 78 X 1.5	661590		\$2,107
Hitachi 160	662167		\$1,810
Hitachi EX230-LC-5	661334		\$2,107

MOUNTING BRACKETS FOR EXCAVATORS CONTINUED NEXT PAGE

## PENGO AUGER MOUNTING KITS AND COMPONENTS

### QUICK END OF STICK MOUNTING BRACKETS

PENGO AUGER MODELS DT-5, DT-15, DV-20 - 45MM	ORDER CODE	SHIP WEIGHT (LBS)	LIST PRICE
<b>End of Stick Mount</b>			
Hitachi 2450	661339		\$2,107
John Deere 160	662167		\$1,810
John Deere 410G	661390		\$2,107
John Deere D-350 MINI EX	661221		\$2,107
Komatsu PC-220	661222		\$1,738
Komatsu PC-120 6E020	662131		\$2,060
Komatsu PC35MR-1&2	661490		\$2,107
Komatsu PC 60	661336		\$2,107
Komatsu PC-138	661333		\$2,107
Komatsu PC-78	661346		\$2,107
Kubota KX040	661968		\$2,107
New Holland EH-50 MINI	661287		\$1,482
Sany 135	661906		POR
Takeuchi TB180FR	661574		\$2,060
Volvo 220 EL	661909		\$2,405
Volvo EC150	661566		\$2,060
Wacker Neuson E125	662117		POR

Add Surcharge to all products 8.85%

# AUGERS

## SOIL CHART

Pengo has developed the below chart to help you decide which auger will be best suited for your project. The above triangles and color guide will be included with all products where applicable.

<b>1</b>	dirt; peat, organic silts, very loose sand, very soft, swamp, marsh
<b>2</b>	sand; loose, fine sand; loess and medium clay, flood plain soils, lake clay
<b>3</b>	silt; coarse sand to stiff clay, dense hydraulic fill, compacted fill, residual soils
<b>4</b>	clay; stiff to very stiff clay, glacial till, hard-pan, marls
<b>5</b>	gravel; basalt, very hard silts and clay, weathered laminated rock
<b>6</b>	fracturable rock; caliche, coarse gravel and cobbles; frozen soil
<b>7</b>	non-fracturable rock; granite, basalt, massive limestone

Add Surcharge to all products 8.85%

## AUGER BITS

### LANDSCAPE AGGRESSOR® AUGER BITS

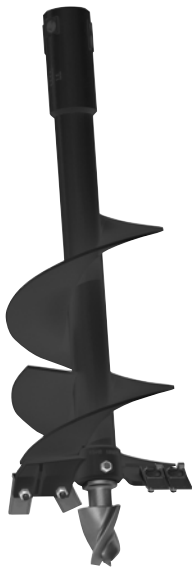

Pengo's® Landscape Aggressor® is the perfect tool for landscaping applications or where smaller prime movers are required. Shorten flight bodies offers substantial weight reduction and performance is enhanced with our double entry flight design. Paired with our TriFlow® 350 pilot, providing three drill points for longer wear, the Landscape Aggressor provides big performance in a small package.



LANDSCAPE AGGRESSOR® AUGERS	ORDER CODE	SHIP WEIGHT (LBS)	LIST PRICE
<b>30" Landscape Aggressor Augers 2" Round</b>			
6" x 30" (2 teeth) 2" round	138400	35	\$377
9" x 30" (4 teeth) 2" round	138405	42	\$395
12" x 30" (4 teeth) 2" round	138410	48	\$411
<b>36" Landscape Aggressor Augers 2" Hex</b>			
6" x 36" (2 teeth) 2" hex	243182	34	\$495
9" x 36" (4 teeth) 2" hex	243183	44	\$525
12" x 36" (4 teeth) 2" hex	243184	48	\$555
15" x 36" (5 teeth) 2" hex	243185	57	\$585
18" x 36" (6 teeth) 2" hex	243186	67	\$615
<b>36" Landscape Aggressor Augers 2.56" Round</b>			
6" x 36" (2 teeth) 2.56" round	243187	33	\$495
9" x 36" (4 teeth) 2.56" round	243188	43	\$525
12" x 36" (4 teeth) 2.56" round	243189	47	\$555
15" x 36" (5 teeth) 2.56" round	243190	56	\$585
18" x 36" (6 teeth) 2.56" round	243191	66	\$615
<b>48" Landscape Aggressor Augers 2" Round</b>			
6" x 48" (2 teeth) 2" round	138010	50	\$550
9" x 48" (4 teeth) 2" round	138011	58	\$585
12" x 48" (4 teeth) 2" round	138012	68	\$620
15" x 48" (5 teeth) 2" round	138013	78	\$675
18" x 48" (6 teeth) 2" round	138014	85	\$710

# AUGERS

## AUGER BITS

### AGGRESSOR® AUGER BITS



Pengo's® Aggressor® Auger is the standard in which all others are measured, a professional grade tool designed for daily and constant use. The patented Tri-Flow pilot provides unmatched auger stability as well as up to 50% longer wear over conventional pilot bits. Double flight technology provides maximum spoil removal and the 5/16" flight thickness provides the long term durability demanded for daily use.



AGGRESSOR® AUGERS	ORDER CODE	SHIP WEIGHT (LBS)	LIST PRICE
<b>36" Aggressor Augers 2" Hex</b>			
6" x 36" (2 teeth) 2" hex	236011	39	\$406
9" x 36" (4 teeth) 2" hex	236012	55	\$498
12" x 36" (4 teeth) 2" hex	236013	68	\$551
15" x 36" (5 teeth) 2" hex	236014	73	\$726
18" x 36" (6 teeth) 2" hex	236015	70	\$846
<b>36" Aggressor Augers 2.56" Round</b>			
6" x 36" (2 teeth) 2.56" round	236016	37	\$406
9" x 36" (4 teeth) 2.56" round	236017	54	\$498
12" x 36" (4 teeth) 2.56" round	236018	66	\$551
15" x 36" (5 teeth) 2.56" round	236019	72	\$726
18" x 36" (6 teeth) 2.56" round	236020	69	\$846
<b>49" Aggressor Augers 2" Hex</b>			
6" x 49" (2 teeth) 2" hex	PNG104152	54	\$410
9" x 49" (4 teeth) 2" hex	PNG104153	78	\$520
<b>49" Aggressor Augers 2.56" Round</b>			
6" x 49" (2 teeth) 2.56" round	PNG104168	54	\$410
9" x 49" (4 teeth) 2.56" round	PNG104169	78	\$520

AGGRESSOR AUGERS CONTINUED NEXT PAGE

## AUGER BITS

### AGGRESSOR® AUGER BIT CONT.

AGGRESSOR® AUGERS	ORDER CODE	SHIP WEIGHT (LBS)	LIST PRICE
<b>51" Aggressor Augers 2" Hex</b>			
12" x 51" (4 teeth) 2" hex	PNG104154	114	\$645
15" x 51" (5 teeth) 2" hex	PNG104155	117	\$836
18" x 51" (6 teeth) 2" hex	PNG104156	145	\$999
24" x 51" (8 teeth) 2" hex	PNG104157	210	\$1,180
30" x 51" (10 teeth) 2" hex	PNG104158	225	\$1,477
36" x 51" (12 teeth) 2" hex	PNG104159	295	\$1,800
<b>51" Aggressor Augers 2.56" Round</b>			
12" x 51" (4 teeth) 2.56" round	PNG104170	114 lbs	\$645
15" x 51" (5 teeth) 2.56" round	PNG104171	117 lbs	\$836
18" x 51" (6 teeth) 2.56" round	PNG104172	145 lbs	\$999
24" x 51" (8 teeth) 2.56" round	PNG104173	210 lbs	\$1,180
30" x 51" (10 teeth) 2.56" round	PNG104174	225 lbs	\$1,477
36" x 51" 12 teeth) 2.56" round	104175	295 lbs	\$1,800

### AGGRESSOR® TREE AUGER BITS



Pengo's® Aggressor® tree auger is a more robust version of our Landscape Aggressor Tree Auger and made specifically for high-duty cycle applications. Offering the same two-stage design that produces a tailored fit for the root ball, and the ability to change the pilot and teeth to accommodate light rock and permafrost soil conditions.



AGGRESSOR® TREE AUGERS	ORDER CODE	SHIP WEIGHT (LBS)	LIST PRICE
<b>51" Aggressor Tree Augers 2" Hex</b>			
9"/18" x 51" (8 teeth) 2" hex	135554	155	\$925
12"/24" x 51" (9 teeth) 2" hex	135555	160	\$1,050
15"/30" x 51" (11 teeth) 2" hex	135556	255	\$1,300
18"/36" x 51" (13 teeth) 2" hex	135557	290	\$1,520

# AUGERS

## AUGER BITS

### TRIMAX® AUGER BITS



Pengo's® TriMax® auger is designed to handle your most challenging applications across a variety of drilling conditions. Available in both single and double flight configurations, the TriMax features our TriFlow® Pilot, which provides unmatched stability and wear characteristics. Combined with our Fas-N-Lok® teeth and cast head with compound angles; dirt, sand, silt or gravel are no match for the TriMax.



TRIMAX® AUGERS	ORDER CODE	SHIP WEIGHT (LBS)	LIST PRICE
<b>36" Trimax Augers 2" Hex</b>			
6" x 36" (2 teeth) 2" hex	243192	43	\$515
9" x 36" (4 teeth) 2" hex	243193	51	\$600
12" x 36" (4 teeth) 2" hex	243194	64	\$695
16" x 36" (6 teeth) 2" hex	243195	85	\$809
18" x 36" (6 teeth) 2" hex	243196	95	\$949
24" x 36" (8 teeth) 2" hex	243197	98	\$1,150
30" x 36" (10 teeth) 2" hex	243198	133	\$1,360
36" x 36" (12 teeth) 2" hex	243199	171	\$1,514
<b>36" Trimax Augers 2.56" Round</b>			
6" x 36" (2 teeth) 2.56" round	243200	42 lbs	\$515
9" x 36" (4 teeth) 2.56" round	243201	50 lbs	\$600
12" x 36" (4 teeth) 2.56" round	243202	63 lbs	\$695
16" x 36" (6 teeth) 2.56" round	243203	84 lbs	\$809
18" x 36" (6 teeth) 2.56" round	243204	94 lbs	\$949
24" x 36" (8 teeth) 2.56" round	243205	97 lbs	\$1,150
30" x 36" (10 teeth) 2.56" round	243206	132 lbs	\$1,360
36" x 36" (12 teeth) 2.56" round	243207	170 lbs	\$1,514

TRIMAX AUGERS CONTINUED NEXT PAGE

## AUGER BITS

### TRIMAX<sup>®</sup> AUGER BIT CONT.

TRIMAX <sup>®</sup> AUGERS	ORDER CODE	SHIP WEIGHT (LBS)	LIST PRICE
<b>48" Trimax Augers 2" Hex</b>			
6" x 48" (2 teeth) 2" hex	104091	62	\$640
9" x 48" (4 teeth) 2" hex	104093	78	\$758
12" x 48" (4 teeth) 2" hex	104095	106	\$804
16" x 48" (6 teeth) 2" hex	104097	100	\$1,030
18" x 48" (6 teeth) 2" hex	104098	124	\$1,212
24" x 48" (8 teeth) 2" hex	104100	166	\$1,570
30" x 48" (10 teeth) 2" hex	104101	207	\$1,745
36" x 48" (12 teeth) 2" hex	104102	270	\$1,945
48" x 48" (18 teeth) 2" hex	104104	375	\$2,245
<b>48" Trimax Augers 2.5" Hex</b>			
6" x 48" (2 teeth) 2.5" hex	243230	77	\$690
9" x 48" (4 teeth) 2.5" hex	243231	91	\$800
12" x 48" (4 teeth) 2.5" hex	243232	95	\$850
16" x 48" (6 teeth) 2.5" hex	243233	136	\$1,080
18" x 48" (6 teeth) 2.5" hex	243234	187	\$1,260
24" x 48" (8 teeth) 2.5" hex	243235	171	\$1,620
30" x 48" (10 teeth) 2.5" hex	243236	228	\$1,795
36" x 48" (12 teeth) 2.5" hex	243237	269	\$1,995
<b>48" Trimax Augers 2.56" Round</b>			
6" x 48" (2 teeth) 2.56" round	104108	61	\$640
9" x 48" (4 teeth) 2.56" round	104110	77	\$758
12" x 48" (4 teeth) 2.56" round	104112	105	\$804
16" x 48" (6 teeth) 2.56" round	104114	99	\$1,030
18" x 48" (6 teeth) 2.56" round	104115	123	\$1,212
24" x 48" (8 teeth) 2.56" round	104117	165	\$1,570
30" x 48" (10 teeth) 2.56" round	104118	206	\$1,745
36" x 48" (12 teeth) 2.56" round	104119	269	\$1,945

Single flight Trimax models available. Speak to your local representative for more information.

# AUGERS

## AUGER BITS

### SEVERE ROCK RIPPER® AUGER BITS



Pengo's® Severe Rock Ripper® (SRR) is specifically designed to handle the most difficult rock applications. Featuring our Rock Ripper® Pilot, ½" thick hard faced flighting, and carbide conical teeth; the SRR is the most robust tool in the GP line-up. Our SRR can also be equipped with our Strata series of teeth, which provides drilling grade carbide and maximizes both performance and drilling efficiencies



SEVERE ROCK RIPPER® AUGERS	ORDER CODE	SHIP WEIGHT (LBS)	LIST PRICE
<b>48" Severe Rock Ripper Augers 2" Hex</b>			
6" x 48" (8 teeth) 2" hex	137950	80	\$1,125
9" x 48" (10 teeth) 2" hex	137951	108	\$1,424
12" x 48" (12 teeth) 2" hex	137952	130	\$1,579
16" x 48" (15 teeth) 2" hex	137953	170	\$2,050
18" x 48" (16 teeth) 2" hex	137954	192	\$2,270
24" x 48" (20 teeth) 2" hex	137956	285	\$3,050
30" x 48" (24 teeth) 2" hex	137957	345	\$3,615
36" x 48" (26 teeth) 2" hex	137958	415	\$4,295

The SRR Auger comes standard with the S-RL08 conical teeth.  
 Replace with SR-76SW Strata® conical teeth for increased performance and life-cycle.

Add Surcharge to all products 8.85%

## AUGER TEETH

### 40/50 AUGER TEETH



40/50 AUGER TEETH	COMPATABILITY	SOIL	ORDER CODE	SHIP WEIGHT (LBS)	LIST PRICE
40/50	Aggressor	1 2 3	134501	.5	\$9
40/50HFF	Aggressor	2 3 4	134802	.5	\$17
40/50C	Aggressor	4 5	134519	.65	\$31
Carriage Bolt	-	-	1872	-	\$3
Hex Nut Lock	-	-	1841	-	\$4

### FAS-N-LOK AUGER TEETH

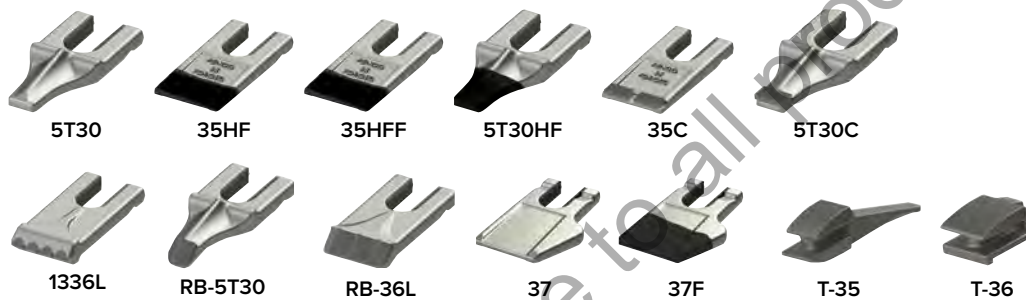

40/50 AUGER TEETH	COMPATABILITY	SOIL	ORDER CODE	SHIP WEIGHT (LBS)	LIST PRICE
35	Trimax	1 2 3	133835	.4	\$8
5T30	Trimax	1 2 3	140029	.4	\$8
37	Trimax	1 2 3	140027	.5	\$9
37F	Trimax	2 3 4	140010	.6	\$13
35 HF	Trimax	2 3 4	140008	.6	\$14
35 HFF	Trimax	2 3 4	140009	.6	\$18
5T30 HF	Trimax	2 3 4	140014	.4	\$16
35 C	Trimax	4 5	140007	.4	\$27
5T30 C	Trimax	4 5	140012	.4	\$20
1336L	Trimax	4 5	140016	.6	\$28
RB-5T30	Trimax	4 5 6	140013	.4	\$20
RB-36L	Trimax	4 5 6	140021	.6	\$28
T-35 Holder	-	-	171221	1	\$28
T-36 Holder	-	-	171231	1	\$32

# AUGERS

## AUGER TEETH

### CONICAL AUGER TEETH

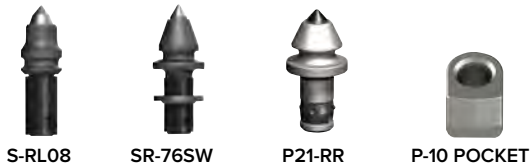

CONICAL AUGER TEETH	COMPATABILITY	SOIL	ORDER CODE	SHIP WEIGHT (LBS)	LIST PRICE
S-RL08	Severe Rock Ripper		PNG990021	.5	\$14
SR-76SW	Severe Rock Ripper		780001	.5	\$17
P21-RR	BoRH		137990	.65	\$25
P-10	Severe Rock Ripper	-	PNG990043	-	\$30

### PILOT BITS

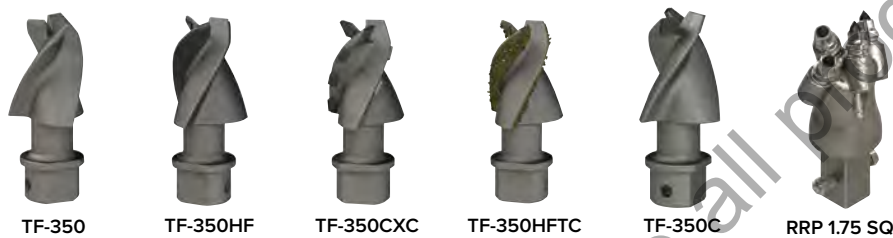

PILOT BITS	COMPATABILITY	SOIL	ORDER CODE	SHIP WEIGHT (LBS)	LIST PRICE
TF-350	Aggressor / Trimax		135088	5	\$45
TF-350HF	Aggressor / Trimax		135089	5.5	\$162
TF-350CXC	Aggressor / Trimax		135091	5.8	\$265
TF-350HFTC	Aggressor / Trimax		135092	5.5	\$467
TF-350C	Aggressor / Trimax		135090	5.5	\$130
RRP 1.75 SQ	Severe Rock Ripper		137208	15	\$264
3.5" Hex Bolt 6" - 9" Dia.	-	-	1098	-	POR
4" Hex Bolt 12"+ Dia.	-	-	1100	-	\$5
Hex Nut Lock	-	-	1841	-	\$4

## AUGERS BORH AND EXTENSIONS

### BORH® KITS FOR AGGRESSOR AUGERS

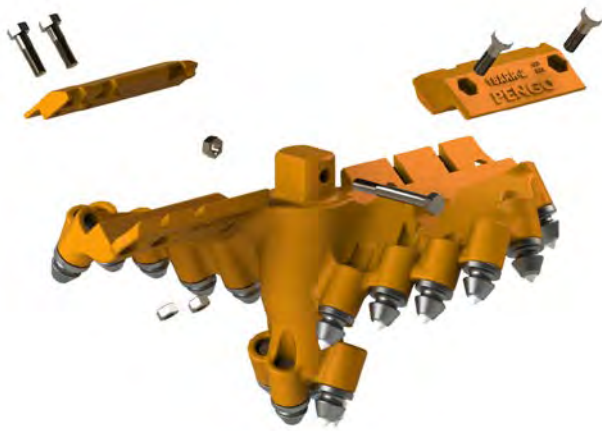

Pengo's patented BoRH® (Bolt on Rock Head) provides the ultimate solution for all your drilling applications. Designed to convert a standard Aggressor Dirt Auger into a rock auger, the BoRH eliminates the need for an additional and dedicated Rock Auger. The BoRH kit contains our boring head, pilot bit, wear caps, bullet-style carbide teeth and all hardware needed to complete the installation. Featuring innovative wear caps and enlarged shoulders on the teeth for increased wear, the BoRH system provides the ultimate solution across a wide variety of soil conditions.



BoRH KITS	ORDER CODE	SHIP WEIGHT (LBS)	LIST PRICE
6" Diameter BoRH (8 teeth)	137991	24	\$450
9" Diameter BoRH (10 teeth)	137992	36	\$553
12" Diameter BoRH (12 teeth)	137993	43	\$601
15" Diameter BoRH (15 teeth)	137994	47	\$642
18" Diameter BoRH (18 teeth)	137995	56	\$678
24" Diameter BoRH (24 teeth)	137996	79	\$830

### EXTENSIONS

AUGER EXTENSIONS	ORDER CODE	SHIP WEIGHT (LBS)	LIST PRICE
<b>Telescoping Extensions 2" Hex</b>			
12" Length, 2" hex	557142	22	\$400
24" Length, 2" hex	557143	34	\$427
36" Length, 2" hex	557144	46	\$644
48" Length, 2" hex	557145	58	\$466
60" Length, 2" hex	557146	69	\$856
72" Length, 2" hex	557147	82	\$905
<b>Fixed Extensions 2" Round</b>			
12" Length, 2" round	557176	20	\$408
24" Length, 2" round	557178	31	\$592
36" Length, 2" round	557174	40	\$631
<b>Fixed Extensions 2.56" Round</b>			
12" Length, 2.56" round	134203	20	\$395
24" Length, 2.56" round	134204	31	\$438
36" Length, 2.56" round	134205	40	\$427
48" Length, 2.56" round	134206	50	\$432
60" Length, 2.56" round	134207	61	\$465



# AUGERS

## AUGER HUBS, ADAPTERS, AND INSTALL TOOLS

### HUBS

HUBS	ORDER CODE	SHIP WEIGHT (LBS)	LIST PRICE
<b>Replacement Hubs</b>			
2" Round Case	154080	5.2	\$110
2 9/16" Universal	154115	9.5	\$127
2" Hex Universal	154121	10.5	\$147
<b>Hub Adapters</b>			
2" Hex Female x 2 9/16" Round Male	134211	20	\$304
2" Hex Female x 2" Round Male	557156	14	\$427
2 1/2" Hex Female x 2" Hex Male	132419	30	\$409
2 1/4" Hex Female x 2" Hex Male	557159	20	\$398
2" Round Female x 2" Hex Male	132804	13	\$353
2" Round Female x 2 9/16" Round Male	134210	15	\$279
2 9/16" Round Female x 2 1/2" Hex Male	133906	21	\$488
2 9/16" Round Female x 2" Round Male	132068	13	\$537
2 9/16" Round Female x 2" Square Male	557155	19	\$560
2 9/16" Round Female x 2" Hex Male	557153	18	\$336



### INSTALLATION & REMOVAL TOOLS



Soft Hammer



Drift Punch



C30 Puller



C123 Puller

INSTALLATION & REMOVAL TOOLS	COMPATABILITY	ORDER CODE	SHIP WEIGHT (LBS)	LIST PRICE
Soft Hammer	-	137737	3.5	\$50
Drift Punch	-	137750	1	\$48
C30 Puller	SR-76SW Strata Tooth	134090	3	\$124
C123 Puller	S-RL08 Teeth	134091	3	\$107

## PENGO AUGER BITS

### EXCAVATOR AUGERS - QUICK CHANGE

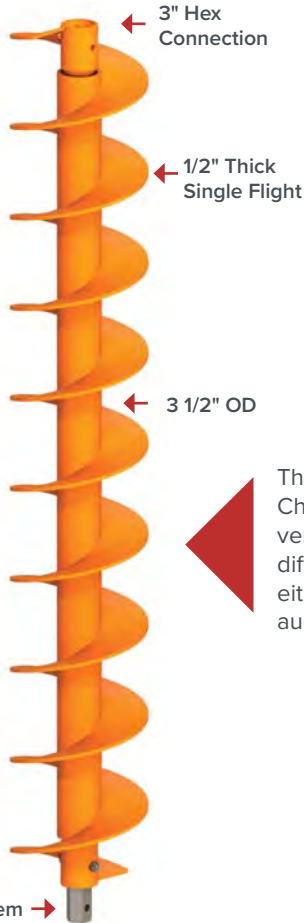

Pengo's Excavator Quick Change system is the perfect solution for turning your excavator into a dedicated drilling machine. Regardless of excavator brand or size our quick change system provides maximum flexibility and customization for a tailored made installation. Each system is a total package designed to match your excavator specifications. Featuring Revolution hydraulic drive heads, your choice between end of stick or quick connect mounting systems, multiple length flight bodies, and (3) separate drill head options, you can drill effectively in all soil conditions, from dirt to rock, both fracturable and non-fracturable

The Excavator Quick Change allows the versatility to use three different heads with either a 5', 10' or 20' auger flight section.



#### AVAILABLE OPTIONS:

##### 1. Standard Dirt

TF-1000 Pilot,  
2070Band  
2072 Fas-N-Lok®  
Teeth

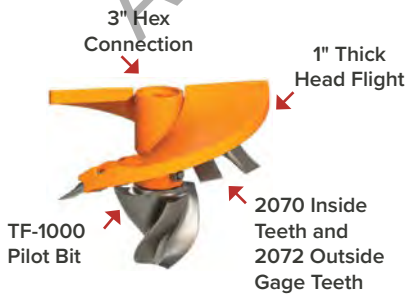

##### 2. Step Rock

P-6000 Pilot  
and  
604C Drag  
Style Tooth



##### 3. Rock Option

C31-HD Pilot  
and  
SR-100 STRATA®  
Conical Teeth



QUICK CHANGE AUGERS CONTINUED NEXT PAGE

# AUGERS

## EXCAVATOR AUGERS - QUICK CHANGE CONT.

### FLIGHT SECTIONS

	ORDER CODE	SHIP WEIGHT (LBS)	LIST PRICE
<b>5' Section   3" Hex</b>			
16" x 5', 3" hex	165442	275	\$3,018
18" x 5', 3" hex	165443	335	\$3,218
20" x 5', 3" hex	165444	415	\$3,418
24" x 5', 3" hex	165445	470	\$3,668
30" x 5', 3" hex	165446	480	\$3,918
36" x 5', 3" hex	165447	610	\$4,218
42" x 5', 3" hex	165448	760	\$4,518
48" x 5', 3" hex	165449	935	\$4,818
<b>10' Section   3" Hex</b>			
16" x 10', 3" hex	165450	490	\$8,563
18" x 10', 3" hex	165452	570	\$8,763
20" x 10', 3" hex	165454	660	\$8,963
24" x 10', 3" hex	165456	730	\$9,263
30" x 10', 3" hex	165458	914	\$9,463
36" x 10', 3" hex	165460	1170	\$9,663
42" x 10', 3" hex	165462	1260	\$9,863
48" x 10', 3" hex	165464	1325	\$10,063

### PIN ON HEAD ASSEMBLIES

	ORDER CODE	SHIP WEIGHT (LBS)	LIST PRICE
<b>Step Rock Heads - P-6000 Pilot Bit and 604C Drag Style Tooth</b>			
16" diameter, 8 teeth	165490		\$4,478
18" diameter, 9 teeth	165492		POR
20" diameter, 10 teeth	165494		POR
24" diameter, 12 teeth	165496	123	\$4,718
30" diameter, 15 teeth	165498		\$5,453
36" diameter, 18 teeth	165500		\$5,643
42" diameter, 21 teeth	165502		\$6,809
48" diameter, 24 teeth	165504		POR
<b>Rock Heads - C31HD-8.5 Pilot (12"-30"), B47-10 Pilot (36"-54"), STRATA SR-100 Teeth</b>			
16" diameter, 12 teeth	165510	165	\$2,273
18" diameter, 13 teeth	165512	185	\$2,308
20" diameter, 15 teeth	165514	210	POR
24" diameter, 16 teeth	165516	265	\$2,390
30" diameter, 21 teeth	165518	276	POR
36" diameter, 24 teeth	165520	320	\$3,405
42" diameter, 28 teeth	165522	336	\$3,769
48" diameter, 32 teeth	165524	346	\$3,772

PIN ON HEAD ASSEMBLIES CONTINUED NEXT PAGE

## EXCAVATOR AUGERS - QUICK CHANGE CONT.

### PIN ON HEAD ASSEMBLIES

	ORDER CODE	SHIP WEIGHT (LBS)	LIST PRICE	
<b>Carbide Heads - TF-1000 Pilot Bit, 2078 and 2079 Fas-N-Lok Gage Teeth</b>				
16" diameter, 2 (2079) teeth	165471	135	\$820	
18" diameter, 3 (2079) teeth	165473	155	\$1,347	
20" diameter, 4 (2079) teeth	165475	167	\$1,677	
24" diameter, 5 (2079) teeth	165477	185	\$2,654	
30" diameter, 6 (2079) teeth	165479	185	POR	
36" diameter, 2 (2078) teeth, 8 (2079) teeth	165481	340	\$2,750	
42" diameter, 2 (2078) teeth, 10 (2079) teeth	165483	355	\$4,212	
48" diameter, 2 (2078) teeth, 10 (2079) teeth	165485	403	\$4,412	
<b>Dirt Heads - TF-1000 Pilot Bit, 2070 and 2072 Fas-N-Lok Dirt Teeth</b>				
16" diameter, 2 (2072) teeth	165470	136	\$1,043	
18" diameter, 1 (2070) teeth, 2 (2072) teeth	165472	155	\$1,147	
20" diameter, 2 (2070) teeth, 2 (2072) teeth	165474	183	\$1,332	
24" diameter, 3 (2070) teeth, 2 (2072) teeth	165476	206	\$1,835	
30" diameter, 4 (2070) teeth, 2 (2072) teeth	165478	249	\$2,264	
36" diameter, 6 (2070) teeth, 2 (2072) teeth	165480	333	POR	
42" diameter, 8 (2070) teeth, 2 (2072) teeth	165482	376	POR	
48" diameter, 10 (2070) teeth, 2 (2072) teeth	165484	426	POR	
<b>ACCESSORIES</b>				
	SOIL	ORDER CODE	SHIP WEIGHT (LBS)	LIST PRICE
Pin Auger [DP-2] Drive Pin	-	157779	0.1	\$12
Pin Auger [DP-3] Drive Pin	-	157780	0.1	\$11
Pin Auger [DP-4] Drive Pin	-	157781	0.3	\$17
Pin Auger [DP-5] Drive Pin	-	157782	0.5	\$33
Tooth [2070] Dirt Fas-N-Lok		140002	2	\$26
Tooth [2072] Dirt Gage Fas-N-Lok		140000	2.3	\$25
Tooth [2077] Carbide Fas-N-Lok		140003	.7	\$49
Tooth [2078] Carbide Gage Fas-N-Lok		140004	1	\$55
Tooth [2079] Carbide Fas-N-Lok		140001	3.3	\$60
Tooth [604-C] Carbide Rock		140065	1	\$28
Tooth [SR-100]		780002	1.1	\$16
Pilot Bit [TF-1000HFTC] 2-1/2 SQ		137354	46	\$689
Pilot Bit [P-6000] 4 3/4 Dia 4 Step		151275	8	\$661
Pilot Bit [C31HD-8.5] 2.5 SQ Pin/Washer		135913	30	\$451
Pilot Adapter [2.5" SQ x 6"OD] Cast	-	151598		\$98

## EXCAVATOR AUGERS - S-400 OR S-130MM CONNECTION

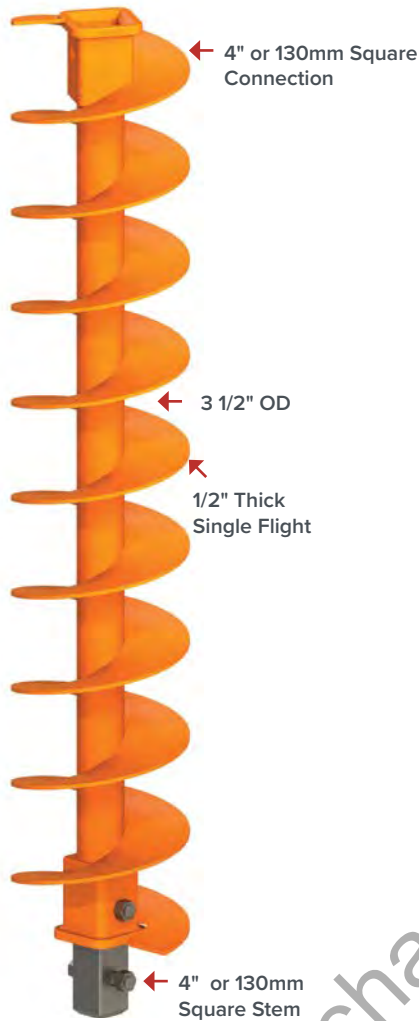

Pengo continues to provide solutions for our customers. With the introduction of the Revolution Series Drilling drives came the need for a complete excavator auger system. This system is available for both rock and dirt drilling and come in five foot sections. Each five foot section attaches to a five foot or ten foot flight section.



### AVAILABLE LEAD SECTIONS:

#### ROCK



#### DIRT



Add Surcharge to all products @ 35%

EXCAVATOR AUGERS CONTINUED NEXT PAGE

## EXCAVATOR AUGERS - S-400 OR S-130MM CONNECTION CONT.

### FLIGHT SECTIONS

	ORDER CODE	SHIP WEIGHT (LBS)	LIST PRICE
<b>5' Section   4" Square</b>			
16" x 5', 4" square	165759		\$6,245
18" x 5', 4" square	165762		\$6,445
20" x 5', 4" square	165763		\$6,645
24" x 5', 4" square	165764		\$6,845
30" x 5', 4" square	165765		\$7,045
36" x 5', 4" square	165766		\$7,245
42" x 5', 4" square	165767		\$7,445
48" x 5', 4" square	165768		\$7,645
<b>10' Section   4" Square</b>			
16" x 10', 4" square	165712		\$10,635
18" x 10', 4" square	165713		\$10,835
20" x 10', 4" square	165714		\$11,035
24" x 10', 4" square	165715		\$11,235
30" x 10', 4" square	165592		\$11,435
36" x 10', 4" square	165716		\$11,635
42" x 10', 4" square	165717		\$11,835
48" x 10', 4" square	165718		\$12,035
<b>5' Rock Lead Section for S-400 Connection - C31-HD 8.5 Pilot Bit, Strata SR-100 Conical Teeth</b>			
16" x 5', 4" square, 12 teeth	165700		POR
18" x 5', 4" square, 13 teeth	165701		POR
20" x 5', 4" square, 15 teeth	165702		POR
24" x 5', 4" square, 16 teeth	165584		POR
30" x 5', 4" square, 21 teeth	165587		POR
36" x 5', 4" square, 24 teeth	165703		POR
42" x 5', 4" square, 28 teeth	165704		POR
48" x 5', 4" square, 32 teeth	165705		POR
<b>5' Dirt Lead Section for S-400 Connection - TF-1000 Pilot Bit, 2070 and 2072 Fas-N-Lok Dirt Teeth</b>			
16" x 5', 4" square, 2 (2072) teeth	165706		POR
18" x 5', 4" square, 1 (2070), 2 (2072) teeth	165707		POR
20" x 5', 4" square, 2 (2070), 2 (2072) teeth	165708		POR
24" x 5', 4" square, 3 (2070), 2 (2072) teeth	165585		POR
30" x 5', 4" square, 4 (2070), 2 (2072) teeth	165588		POR
36" x 5', 4" square, 6 (2070), 2 (2072) teeth	165709		POR
42" x 5', 4" square, 8 (2070), 2 (2072) teeth	165710		POR
48" x 5', 4" square, 10 (2070), 2 (2072) teeth	165711		POR

EXCAVATOR FLIGHT SECTIONS CONTINUED NEXT PAGE

# AUGERS

## EXCAVATOR AUGERS - S-400 OR S-130MM CONNECTION CONT.

AUGERS

### FLIGHT SECTIONS

	ORDER CODE	SHIP WEIGHT (LBS)	LIST PRICE
<b>5' Section   130mm Square</b>			
16" x 5', 130mm square	165769		\$9,041
18" x 5', 130mm square	165770		\$9,241
20" x 5', 130mm square	165771		\$9,441
24" x 5', 130mm square	165772		\$9,641
30" x 5', 130mm square	165773		\$9,841
36" x 5', 130mm square	165774		\$10,041
42" x 5', 130mm square	165775		\$10,241
48" x 5', 130mm square	165776		\$10,591
<b>10' Section   130mm Square</b>			
16" x 10', 130mm square	165743		\$13,335
18" x 10', 130mm square	165744		\$13,535
20" x 10', 130mm square	165745		\$13,735
24" x 10', 130mm square	165746		\$13,935
30" x 10', 130mm square	165747		\$14,235
36" x 10', 130mm square	165748		\$14,635
42" x 10', 130mm square	165749		\$15,135
48" x 10', 130mm square	165750		\$15,735
<b>5' Rock Lead Section for S-130mm Connection - C31-HD 8.5 Pilot Bit, Strata SR-100 Conical Teeth</b>			
16" x 5', 130mm square, 12 teeth	165727		POR
18" x 5', 130mm square, 13 teeth	165728		POR
20" x 5', 130mm square, 15 teeth	165729		POR
24" x 5', 130mm square, 16 teeth	165730		POR
30" x 5', 130mm square, 21 teeth	165731		POR
36" x 5', 130mm square, 24 teeth	165732		POR
42" x 5', 130mm square, 28 teeth	165733		POR
48" x 5', 130mm square, 32 teeth	165734		POR
<b>5' Dirt Lead Section for S-130mm Connection - TF-1000 Pilot Bit, 2070 and 2072 Fas-N-Lok Dirt Teeth</b>			
16" x 5', 130mm square, 2 (2072) teeth	165735		POR
18" x 5', 130mm square, 1 (2070), 2 (2072) teeth	165736		POR
20" x 5', 130mm square, 2 (2070), 2 (2072) teeth	165737		POR
24" x 5', 130mm square, 3 (2070), 2 (2072) teeth	165738		POR
30" x 5', 130mm square, 4 (2070), 2 (2072) teeth	165739		POR
36" x 5', 130mm square, 6 (2070), 2 (2072) teeth	165740		POR
42" x 5', 130mm square, 8 (2070), 2 (2072) teeth	165741		POR
48" x 5', 130mm square, 10 (2070), 2 (2072) teeth	165742		POR

EXCAVATOR AUGERS ACCESSORIES CONTINUED NEXT PAGE

## EXCAVATOR AUGERS - S-400 OR S-130MM CONNECTION CONT.

ACCESSORIES	SOIL	ORDER CODE	SHIP WEIGHT (LBS)	LIST PRICE
Tooth [2070] Dirt Fas-N-Lok		140002	2	\$26
Tooth [2072] Dirt Gage Fas-N-Lok		140000	2.3	\$25
Tooth [1656] Carbide Rock Fas-N-Lok		140005	.7	\$65
Tooth [1658] Carbide Gage Fas-N-Lok		140006	1	\$77
Tooth [2079] Carbide Fas-N-Lok		140001	3.3	\$60
Tooth [SR-100]		780002	1.1	\$16
Tooth [S31HD]		140065	1.1	\$28
Pilot Bit [TF-1000] 2-1/2 SQ		137348	46	\$279
Pilot Adapter [2.5" SQ x 6"OD] Cast	-	151598		\$98
Pilot Bit [C31HD-8.5] 2.5 SQ Pin/Washer		135913	30	\$451
P30 Pocket	-	990001	.7	\$26
C30 Puller	-	134090	3	\$124
Soft Hammer	-	137737	3.5	\$50

Add Surcharge to all products 8.85%

Add Surcharge to all products 8.85%

# BALE/HAY HANDLING



# BALE TOOLS

## BALE/HAY GRAPPLE BUCKET

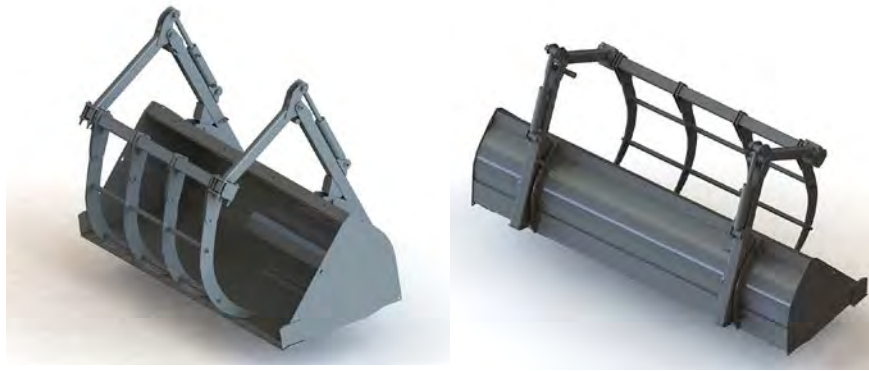

- Single auxiliary hydraulic circuit
- Includes grapple with spill screen
- Optional bolt-on cutting edge

Specifications					
Model	Weight (approx)	Width	Height	Depth	Height
LAF2501	400 lbs	67.68"	56"	48"	85"

Carrier Specifications	
Lift Capacity	Operating Weight
<5,000 lbs.	<15,000 lbs.

## BALE/HAY GRAPPLE BUCKET FOR COMPACT TRACTORS



**INCLUDES: BUCKET, MOUNTING. AND GRAPPLE.**  
**TO ORDER: SELECT ATTACHMENT, ANY OPTIONS.**

BALE / HAY GRAPPLE BUCKET CHECK LOADER CAPACITY BEFORE ORDERING			
	ORDER CODE	SHIP WEIGHT (LBS)	LIST PRICE
72" OD Round Utility Bucket w/ Grapple Kit and Universal Hitch	124472	972	\$6,248
84" OD Round Utility Bucket w/ Grapple Kit and Universal Hitch	124474	1044	\$6,519
96" OD Round Utility Bucket w/ Grapple Kit and Universal Hitch	124476	1086	\$6,763
72" OD Round Utility Bucket w/ Grapple Kit and Euro Global Hitch	124513	972	POR
84" OD Round Utility Bucket w/ Grapple Kit and Euro Global Hitch	124515	1044	\$6,519
96" OD Round Utility Bucket w/ Grapple Kit and Euro Global Hitch	124517	1086	\$7,001

BOLT-ON BALE GRAPPLE* HOSES AND QUICK COUPLER NOT INCLUDED			
	ORDER CODE	SHIP WEIGHT (LBS)	
Bale Grapple	LAF2501-0000	400	\$3,698
Weld-On Rib Kit (required if purchasing Bolt-On Grapple)	LAF2502-0000	NA	\$302

\*For adding to existing buckets

MOUNTING - ADDITIONAL COST MAY APPLY		ORDER CODE	SHIP WEIGHT (LBS)
--------------------------------------	--	------------	-------------------

Contact Customer Service at (833) 723-1843

OPTIONAL - REVERSIBLE CUTTING EDGE KIT INCLUDES BOE, GRADE 8 PLOW BOLTS, LOCK WASHERS & NUTS DRILLED FOR FFC BOLT-ON EDGE (HOLES SPACED 6" APART, CENTER TO CENTER)			
	ORDER CODE	SHIP WEIGHT (LBS)	

For Bucket LAF2572 (7 holes, 11" spacing)	102236	123	\$718
For Bucket LAF2584 (9 holes, 10" spacing)	113978	143	\$963
For Bucket LAF2596 (9 holes, 10.82" spacing)	114197	163	\$881

For Optional Bolt-On Edge Drill Patterns (i.e. Case Hole Patterns) - Call (833) 723-1843

## BALE/HAY GRAPPLE BUCKET - HEAVY-DUTY



### BALE/HAY GRAPPLE BUCKET - HEAVY-DUTY FOR TRACTOR LOADERS/BACKHOES



**INCLUDES: GRAPPLE BUCKET AND MOUNT.**

	ORDER CODE	SHIP WEIGHT (LBS)	LIST PRICE
Cat IT / TH 1.75 cu yd	307150	2100	POR
Cat IT/TH optional edge kit for 307150 1.75 cu yd, 12 holes	14611	225	\$804
JCB Q-fit	308403	2100	POR
JCB (optional edge kit for above 308403)	11002	185	\$800
New Holland-Versattach	308403	2100	POR

### BALE/HAY GRAPPLE BUCKET - HEAVY-DUTY FOR WHEEL LOADERS



**INCLUDES: GRAPPLE BUCKET AND MOUNT.**

	ORDER CODE	SHIP WEIGHT (LBS)	LIST PRICE
CAT IT/TH 1.75 cu yd	307150	2100	POR
Cat IT/TH optional edge kit for 307150 1.75 cu yd, 12 holes	14611	225	\$804

# BALE TOOLS

## BALE CARRIAGE - DUAL LARGE SQUARE



- Designed to pick-up & transfer agriculture materials
- Excellent visibility through frame
- For round or square bale application
- Large heavy duty frame
- Includes tapered forged tines

## BALE CARRIAGE - DUAL LARGE SQUARE FOR TELEHANDLERS



	ORDER CODE	SHIP WEIGHT (LBS)	LIST PRICE
CAT IT/TH	15892	975	\$3,726
JCB Q-fit	12393	975	\$3,726
New Holland-Versattach	12393	975	\$3,726

## BALE CARRIAGE - DUAL LARGE SQUARE FOR TRACTOR LOADERS/BACKHOES



	ORDER CODE	SHIP WEIGHT (LBS)	LIST PRICE
JCB Q-fit	12393	975	\$3,726
CAT IT/TH	15892	975	\$3,726
New Holland - Versattach	12393	975	\$3,726

## BALE CARRIAGE - DUAL LARGE SQUARE FOR WHEEL LOADERS



	ORDER CODE	SHIP WEIGHT (LBS)	LIST PRICE
CAT IT/TH	15892	975	\$3,726
John Deere 544J w/JRB 416MTG	13173	931	\$4,750

Add Surcharge to all products @ 35%

## BALE HUGGER

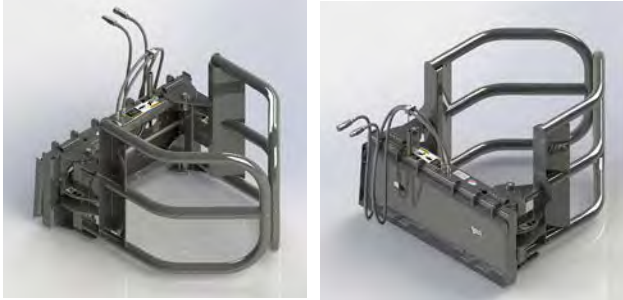

- Provides constant pressure that eliminates risk of dropped bales
- Ideal for 1,000 lb. silage bale, max. load of 2,400 lbs.
- Can lift, move and stack round or rectangular bales

Carrier Specifications	
Lift Capacity	Operating Weight
<10,000 lbs.	<32,000 lbs.

 **NOTE: All replacement hydraulic hoses and fittings must have a minimum rated working pressure of 4000 PSI.**

Specifications				
Model	Width Open	Height	Depth	Weight (approx)
LAF1960	89"	47"	54"	520 lbs

## BALE HUGGER FOR SKID-STEER LOADERS/COMPACT TRACTORS



**INCLUDES: BALE HUGGER AND UNIVERSAL MOUNTING. TO ORDER CHOOSE A BALE HUGGER AND MOUNTING.**

BALE HUGGER CHECK LOADER CAPACITY BEFORE ORDERING			
	ORDER CODE	SHIP WEIGHT (LBS)	LIST PRICE
Bale Hugger (clamps loads from 28" to 80" wide)	LAF1960-0022	520	\$4,280

MOUNTING ADDITIONAL COST MAY APPLY			
	ORDER CODE	SHIP WEIGHT (LBS)	LIST PRICE
Contact Customer Service at (833) 723-1843			

## BALE HUGGER - LARGE ROUND



- 4 to 5 ft opening arms holds wrapped round bales
- Single cylinder allows arms to hug equally
- Fully assembled including hoses & couplers
- Designed with round tubing to prevent damage to wrapped bale coverings

## BALE HUGGER - LARGE ROUND FOR EURO/GLOBAL MOUNTS



	ORDER CODE	SHIP WEIGHT (LBS)	LIST PRICE
Assembly 6 ft.	111776	835	\$6,293

# BALE TOOLS

## BALE SPEAR - CROSS BOLT DESIGN



- Designed to fit compact tractors up to 50 hp
- Picks up one large round bale up to 6' in diameter (see weight limits below)
- Available in single, dual, and triple spears

Bale Spear Specifications							
Model	Weight (approx)	Width OD	Height OD	Depth OD	Round Bale Capacity	Main Spear	Stabilizer Spear
17200-Single	145 lbs	45.25"	22.375"	50.5"	2000 lbs @ 24"	(1) 1.75" x 49"	(2) 1" x 19"
17212-Dual	155 lbs	45.25"	22.375"	50.5"	3000 lbs @ 24"	(2) 1.75" x 49"	NA
11910-Single	195 lbs	45.25"	22.375"	50.5"	3000 lbs @ 24"	(1) 2.1875" x 53"	(2) 1" x 19"
11920-Dual	235 lbs	45.25"	22.375"	50.5"	4000 lbs @ 24"	(2) 2.1875" x 53"	(1) 1" x 19"
17213-triple	230 lbs	45.25"	22.375"	50.5"	4000 lbs @ 24"	(3) 1.75" x 49"	NA
10712	150 lbs	45.25"	22.375"	50.5"	3000 lbs @ 24"	(1) 2.1875" x 53"	(2) 1" x 19"

## BALE SPEAR - CROSS BOLT DESIGN FOR SKID-STEER LOADERS



BALE SPEAR - CHECK LOADER CAPACITY	ORDER CODE	SHIP WEIGHT (LBS)	LIST PRICE
Single Bale Spear (2000 lb. maximum bale size)	17200-0022	145	\$773
Dual Bale Spear (3000 lb. maximum bale size)	17212-0022	155	\$890
Single Heavy Duty Bale Spear (3000 lb. maximum bale size)	11910-0022	222	\$910
Dual Heavy Duty Bale Spear (4000 lb. maximum bale size)	11920-0022	240	\$1,090
Triple Spear (4000 lb. maximum bale size)	17213-0022	230	\$1,328
3 Point Hitch (3000 lb. maximum bale size)	10712-0052	145	\$758

## BALE SPEAR - HEAVY DUTY FOR TRACTOR LOADER/BACKHOES AND WHEEL LOADERS



BALE SPEAR - CHECK LOADER CAPACITY	ORDER CODE	SHIP WEIGHT (LBS)	LIST PRICE
Single Heavy Duty Bale Spear - JRB 418 (3000 lb. maximum bale size)	118186	431	\$2,019
Single Heavy Duty Bale Spear - QCP7000 (3000 lb maximum bale size)	11910-0733	296	\$1,616
Single Heavy Duty Bale Spear - JD TLB QA/JRB E SERIES (3000 lb maximum bale size)	11910-0869	239	\$1,618
Single Heavy Duty Bale Spear - JRB 416 (3000 lb maximum bale size)	12828	399	\$2,019
Dual Heavy Duty Bale Spear - QCP7000 (4000 lb maximum bales size)	11920-0733	356	\$1,227
Dual Heavy Duty Bale Spear	11920-0934	475	\$1,809

REPLACEMENT TINES	ORDER CODE	SHIP WEIGHT (LBS)	LIST PRICE
Bale Spear, 53" x 55mm, Heavy Duty fits 11910, 11920, and 10712	07-10150	38	\$391
Bale Spear, 45mm x 1250mm, cross bolts fits 17200, 17212, 17213	116336	25	\$176

OPTIONAL REPLACEMENT PARTS	ORDER CODE	SHIP WEIGHT (LBS)	LIST PRICE
Small Spike (1" x 19")	13-52026	NA	\$36
Large Spike w/Nut (1-3/4" x 41")	07-10141	NA	\$196

# BOOMS



# BOOMS

## BOOMS - LOADER



- Ideal for moving trees for transplanting
- Use to load and unload attachments, etc.
- Ideal for placing & removing concrete forms
- Adds 6.5 feet of reach to your loader
- Does not include chains or clevis
- Must be shipped with SSL Mounting

Carrier Specifications	
Lift Capacity	Operating Weight
<10,000 lbs.	<32,000 lbs.

Specifications						
Model	Weight (approx)	Width	Load Depth	Depth	Height	Reach
LAF2210	440 lbs	47"	25.1"	31"	73.2"	83.1"



**NOTE:** All replacement hydraulic hoses and fittings must have a minimum rated working pressure of 4000 PSI.

### Maximum Loads That Can Be Safely Lifted



#### Vertical Mast

70% of operating load not to exceed 6,000 lbs



#### Max. Reach

30% of operating load not to exceed 6,000 lbs

## BOOMS - LOADER FOR SKID-STEER LOADERS/COMPACT TRACTORS/TRACTOR LOADER BACKHOES/WHEEL LOADERS EQUIPPED WITH SSL UNIVERSAL MOUNTING



**INCLUDES: LOADER BOOM AND UNIVERSAL SSL MOUNTING.**

LOADER BOOM			
CHECK LOADER CAPACITY BEFORE ORDERING			
	ORDER CODE	SHIP WEIGHT (LBS)	LIST PRICE
Loader Boom	LAF2210-0022	440	\$1,916

MOUNTING			
ADDITIONAL COST MAY APPLY			
	ORDER CODE	SHIP WEIGHT (LBS)	LIST PRICE
Contact Customer Service at (833) 723-1843			

## BOOMS - TREE (LIFTING ARMS)



- Fully welded square tube design
- Pintle hook with safety latch on front plate
- Quick attach mounting system for optimal safety & ease of operation
- Ideal for landscapers & nurseries

## BOOMS - TREE FOR WHEEL LOADERS



	ORDER CODE	SHIP WEIGHT (LBS)	LIST PRICE
Cat 902/906/908 (8,000 design rating)	12609	560	\$2,306

## BOOMS - TRUSS (ADJUSTABLE)



- Adjusts to 8', 11', & 13'
- Load ratings: 8' is 4,000 lbs, 11' is 3,000 lbs, & 13' is 2,000 lb
- Pintle hook with safety latch on front plate
- Excellent for all contractors

## BOOMS - TRUSS (ADJUSTABLE) FOR TRACTOR LOADERS/BACKHOES



	ORDER CODE	SHIP WEIGHT (LBS)	
Cat 416C/420D pin mount adjustable truss boom	12688	1175	\$6,195

## BOOMS - TRUSS (ADJUSTABLE) FOR WHEEL LOADERS



	ORDER CODE	SHIP WEIGHT (LBS)	
Cat IT38/IT62	12689	1210	\$6,195
Cat IT14/IT24/IT28	12397	1120	\$6,195
JCB 411/416 & Volvo L40-L120	12396	1120	POR
JRB 416 QA	13225	1220	\$5,063
New Holland LW130-170 adj truss boom	12396	1120	\$6,195

# BOOMS

## BOOMS - TRUSS (ADJUSTABLE)



- Adjusts to 8', 11', & 13'
- Load ratings: 8' is 4,000 lbs, 11' is 3,000 lbs, & 13' is 2,000 lb
- Pintle hook with safety latch on front plate
- Excellent for all contractors

## BOOMS - TRUSS (ADJUSTABLE) FOR TRACTOR LOADERS/BACKHOES



	ORDER CODE	SHIP WEIGHT (LBS)	LIST PRICE
Cat 416C/420D pin mount adjustable truss boom	12688	1175	POR

## BOOMS - TRUSS (ADJUSTABLE) FOR WHEEL LOADERS



	ORDER CODE	SHIP WEIGHT (LBS)	LIST PRICE
Cat IT38/IT62	12689	1210	POR
Cat IT14/IT24/IT28	12397	1120	\$6,195
JCB 411/416 & Volvo L40-L120	12396	1120	POR
JRB 416 QA	13225	1220	\$5,063
New Holland LW130-170 adj truss boom	12396	1120	POR

## BOOMS - TRUSS WITH QUICK ATTACH



- Fully welded square tube design
- Quick attach mounting system standard
- Pintle hook with safety latch on front plate

## BOOMS - TRUSS WITH QUICK ATTACH FOR TRACTOR LOADERS/BACKHOES



12' TRUSS BOOMS W/QUICK ATTACH (2,000 LB. DESIGN RATING)	ORDER CODE	SHIP WEIGHT (LBS)	LIST PRICE
Cat IT/TH	11140	600	\$2,763

**BOOMS - TRUSS WITH HYDRAULIC WINCH**



- 4,000 lb design on 3' & 2,000 lb design on 12' models
- Includes 65' of 7/16" wire rope cable
- Tulsa winch with oil cooled brake & roller bearing swivel hook with latch

**BOOMS - TRUSS WITH HYDRAULIC WINCH FOR WHEEL LOADERS**



3' TRUSS BOOM W/HYDRAULIC WINCH (4,000 LB. DESIGN RATING)	ORDER CODE	SHIP WEIGHT (LBS)	LIST PRICE
Volvo L30-L35	12340	615	\$6,517

Add Surcharge to all products 8.25%

# BRUSH CUTTERS



# BRUSH CUTTERS

GROUND SHARK® BRUSH CUTTERS			
STANDARD DUTY (SD)	HEAVY DUTY (HD)	HIGH PERFORMANCE (HP)	EXTREME DUTY (XD)
			
<b>ROUTINE LAND MAINTENANCE</b>	<b>MORE AGGRESSIVE</b>	<b>MOST RANGE</b>	<b>MOST AGGRESSIVE</b>
Cuts back grass overgrowth and heavy brush up to 4" in diameter. Low-profile design slips easily under fences. The perfect general purpose brush cutter for routine land maintenance.	For heavier brush and trees up to 7" in diameter. Includes carbide mulching teeth and a retractable front shield, allowing blades to fully engage with trees for deep, aggressive cuts.	Handles wider range of vegetation conditions including grass, brush and trees up to 10". Optimized blade carrier design with forged AR400 blades for fast startup and recovery time. Wide 84" cutting path offered for increased productivity. Includes retractable front shield and MulchPower feedback technology.	For very heavy brush and trees up to 10" in diameter. Heavier than the Heavy-Duty version by having; bigger blades, bigger deck, and double-pin blade retention. Includes carbide stump grinding teeth, retractable front shield and MulchPower feedback technology.
Grass, Shrubs, Small Trees	Grass, Shrubs, Medium Trees	Grass, Shrubs, Large Trees	Grass, Shrubs, Large Trees
			
Up to 4" Capacity	Up to 7" Capacity	Up to 10" Capacity	Up to 10" Capacity
15 - 40 GPM	20 - 34 GPM	30 - 40/45 GPM	30 - 45 GPM
1,120 - 1,405 LBS	1,605 - 1,800 LBS	1,780 - 2,260 LBS	2,008 - 2,267 LBS
 Optional	 Optional	 Technology Included	 Technology Included

# BRUSH CUTTERS

FAMILY	MODEL	CUT WIDTH	CUT DIA	MIN CUT HT	WT LBS	FLOW GPM	MOTOR	MULCHPOWER GAUGE	HOSE WRAP	BI-DIRECTIONAL CUTTING
Standard Duty (SD)	GS60SD	60	4	2	1120	15-25	Gerotor	Optional		●
Standard Duty (SD)	GS72SD (A)	72	4	2	1280	15-25	Gerotor	Optional		●
Standard Duty (SD)	GS72SD (B)	72	4	2	1280	26-32	Gerotor	Optional		●
Standard Duty (SD)	GS72SD (C)	72	4	2	1320	33-40	Gerotor	Optional		●
Standard Duty (SD)	GS78SD (A)	78	4	2	1365	15-25	Gerotor	Optional		●
Standard Duty (SD)	GS78SD (B)	78	4	2	1365	26-32	Gerotor	Optional		●
Standard Duty (SD)	GS78SD (C)	78	4	2	1405	33-40	Gerotor	Optional		●
Heavy Duty (HD)	GS66HD	66	7	2.5*	1605	20-34	Gerotor	Optional	●	●
Heavy Duty (HD)	GS72HD	72	7	2.5*	1800	20-34	Gerotor	Optional	●	●
High Performance (HP)	GS72HP	72	10	2.5*	1865	30-45	Radial Piston	●	●	
High Performance (HP)	GS84HP	84	10	2.5*	2178	30-40	Radial Piston	●	●	
Extreme Duty (XD)	GS72XD	72	10	3.25*	2008	30-45	Radial Piston	●	●	
Extreme Duty (XD)	GS78XD	78	10	3.25*	2267	30-45	Radial Piston	●	●	

\*Angled Front Allows Cut to Ground Level

## STANDARD DUTY (SD)

### ROUTINE LAND MAINTENANCE

Cuts back grass overgrowth and heavy brush up to 4" in diameter. Low-profile design slips easily under fences. The perfect general purpose brush cutter for routine land maintenance.

## HEAVY DUTY (HD)

### MORE AGGRESSIVE

For heavier brush and trees up to 7" in diameter. Includes carbide mulching teeth and a patented retractable front shield, allowing blades to fully engage with trees for deep, aggressive cuts.

## HIGH PERFORMANCE (HP)

### MOST RANGE

Handles wider range of vegetation conditions including grass, brush and trees up to 10". Optimized blade carrier design with forged AR400 blades for fast startup and recovery time. Wide 84" cutting path offered for increased productivity. Includes patented retractable front shield and MulchPower™ feedback technology.

## EXTREME DUTY (XD)

### MOST AGGRESSIVE

For very heavy brush and trees up to 10" in diameter. Heavier than the Heavy-Duty version by having; bigger blades, bigger deck, and double-pin blade retention. Includes carbide stump grinding teeth, patented retractable front shield and MulchPower™ feedback technology.

# BRUSH CUTTERS

FAMILY	MODEL	BLADE QTY & TYPE	HEX SHANK BOLT	PUCK BLADE MOUNT	CARBIDE TEETH QTY	DECK THICKNESS	PUSH BAR	SERRATED EDGES - BAR & DECK	DUAL WHEEL KIT	RETRACTABLE SHIELD
Standard Duty (SD)	GS60SD	3 - Bi-Directional				0.25			Opt	
Standard Duty (SD)	GS72SD (A)	3 - Bi-Directional				0.25			Opt	
Standard Duty (SD)	GS72SD (B)	3 - Bi-Directional				0.25			Opt	
Standard Duty (SD)	GS72SD (C)	3 - Bi-Directional				0.25			Opt	
Standard Duty (SD)	GS78SD (A)	3 - Bi-Directional				0.25			Opt	
Standard Duty (SD)	GS78SD (B)	3 - Bi-Directional				0.25			Opt	
Standard Duty (SD)	GS78SD (C)	3 - Bi-Directional				0.25			Opt	
Heavy Duty (HD)	GS66HD	3 - Bi-Directional	•		24	0.25	•	•		•
Heavy Duty (HD)	GS72HD	4 - Bi-Directional	•		48	0.25	•	•		•
High Performance (HP)	GS72HP	3 - Uni-Directional Single Edge	•			0.25	•	•		•
High Performance (HP)	GS84HP	3 - Uni-Directional Single Edge	•			0.31	•	•		•
Extreme Duty (XD)	GS72XD	4 - Uni-Directional Double Bevel Edge / Flippable		•	18	0.25	•	•		•
Extreme Duty (XD)	GS78XD	4 - Uni-Directional Double Bevel Edge / Flippable		•	22	0.25	•	•		•

## FEATURES - ALL MODELS

- Route Hoses Either Side
- Deck Steps on Both Sides
- Blade Accessible Cover
- Bolt-On Replaceable Skid Shoes
- Shielded Motor & Valve Assembly
- Leading Edge Radius Guide
- High-Strength Chain Guard
- Safety Lift Limit Chain
- Braking System
- Audible Braking Signal
- Hydraulic Couplers Included
- Direct Drive
- Tie Down & Lift Points
- High Grade 50 KPSI Yield Deck Steel

# BRUSH CUTTERS

## GROUND SHARK™ STANDARD DUTY

BRUSH CUTTERS



- Dual pressure reliefs on the hydraulic motor allow for bi-directional operation protect against pressure spikes that could damage the drive system.
- Bi-directional forged steel blades (3) allow operator to cut in both directions extending operational life and reducing maintenance cost by cutting heavier brush in one-direction and grass or smaller vegetation in the other.
- The Ground Shark line of brush cutters include special hydraulic valving to shut the cutter head down quickly and safely. There is a distinct audible sound during the shutdown which will indicate to the operator that the blades are coming to a stop.
- Direct drive motor for efficient performance.
- Deck steps on both sides to facilitate different carriers with entry on left or right side. Hose routing can also be configured on either side.
- Deck Leading Edge Radius Guide enables smoother material glide path.
- .25 thick steel deck design.
- Bolt-on replaceable skid shoes.
- An optional MulchPower™ gauge is visible to the operator and helps prevent excessive stalling and overheating.
- Optional dual wheel kits are available that mount to the underside of the front deck to keep the blades off the ground and prevent scalping.

	GS60SD	GS72SD (A)	GS72SD (B)	GS72SD (C)	GS78SD (A)	GS78SD (B)	GS78SD (C)
ORDER CODE	30360A-0022	30372A-0022*	30372B-0022*	30372C-0022*	30378A-0022*	30378B-0022*	30378C-0022*
COUPLER SIZE	1/2 IN.	1/2 IN.	1/2 IN.	1/2 IN.	1/2 IN.	1/2 IN.	1/2 IN.
OVERALL HEIGHT	24 IN.	24 IN.	24 IN.	27 IN.	24 IN.	24 IN.	27 IN.
OVERALL WIDTH	64 IN.	76 IN.	76 IN.	76 IN.	82 IN.	82 IN.	82 IN.
OVERALL LENGTH	76 IN.	88 IN.	88 IN.	88 IN.	9 IN.	94 IN.	94 IN.
CUTTING WIDTH	60 IN.	72 IN.	72 IN.	72 IN.	78 IN.	78 IN.	78 IN.
MINIMUM CUTTING HEIGHT	2 IN.	2 IN.	2 IN.	2 IN.	2 IN.	2 IN.	2 IN.
CUTTING CAPACITY	4 IN.	4 IN.	4 IN.	4 IN.	4 IN.	4 IN.	4 IN.
DECK THICKNESS	.25 IN.	.25 IN.	.25 IN.	.25 IN.	.25 IN.	.25 IN.	.25 IN.
RECOMMENDED FLOW	15-25 GPM	15-25 GPM	26-32 GPM	33-40 GPM	15-25 GPM	26-32 GPM	33-40 GPM
REQUIRED LIFT CAPACITY	1200 LBS	1400 LBS	1400 LBS	1500 LBS	1500 LBS	1500 LBS	1600 LBS
WEIGHT	1120 LBS	1280 LBS	1280 LBS	1320 LBS	1360 LBS	1365 LBS	1405 LBS

\* 5/8" and 3/4" Coupler Models Available, Please Contact Your Local Paladin Rep for More Information

## GROUND SHARK™ STANDARD DUTY CONT.

### GROUND SHARK™ STANDARD DUTY BRUSH CUTTER FOR SKID-STEER LOADERS



**Note:** We highly recommend the purchase of guarding to protect operator and machine from flying debris in harsh forestry and land clearing environments. Please refer to the SSL Forestry Guarding section on page 79 for more information. For Skid-Steer loaders only.

ATTACHES TO SKID-STEER UNIVERSAL HITCH	ORDER CODE	SHIP WEIGHT (LBS)	LIST PRICE
60" Standard Duty (15-25 GPM) with 1/2" couplers, no case drain	30360A-0022	1120	\$8,908
72" Standard Duty (15-25 GPM) with 1/2" couplers, no case drain	30372A-0022*	1280	\$9,656
72" Standard Duty (26-32 GPM) with 1/2" couplers, no case drain	30372B-0022*	1280	\$11,179
72" Standard Duty (33-40 GPM) with 1/2" couplers, with case drain	30372C-0022*	1320	\$11,179
78" Standard Duty (15-25 GPM) with 1/2" couplers, no case drain	30378A-0022*	1360	\$9,842
78" Standard Duty (26-32 GPM) with 1/2" couplers, no case drain	30378B-0022*	1365	\$12,116
78" Standard Duty (33-40 GPM) with 1/2" couplers, with case drain	30378C-0022*	1405	\$12,116

\* 5/8" And 3/4" Coupler Models Available, Please Contact Your Local Paladin Rep for More Information

REPLACEMENT PARTS	ORDER CODE	SHIP WEIGHT (LBS)	LIST PRICE
Replacement Blade Kit - 60"	118330	40	\$366
Replacement Blade Kit - 72"	118331	45	\$412
Replacement Blade Kit - 78"	118332	50	\$437
Skid Shoe Kit	117810	9	\$106
Hose w/Sock .75x96 12MB-12MB 100R19 HS	38742		\$268
Hose w/Sock .38x112 6FJ-8MB 100R2AT HS	38162		\$118
Hose Coupler .38" body female QD 6 FF F 8FB	84928		POR
Hose Coupler .38" body male QD 6 FF M 8FB	84923		POR
Hose Coupler .50" body female QD 8 FF F 12FB	22518		\$80
Hose Coupler .50" body female QD 8 FF M 12FB	22519		\$55
Hose Coupler .625" body female QD 10 FF F 12FB	84921		\$231
Hose Coupler .625" body male QD 10 FF M 12FB	84922		POR
Hose Coupler .75" body female QD 12 FF F 12FB	22520		\$303
Hose Coupler .75" body male QD 12 FF M 12FB	22521		\$263

OPTIONS	ORDER CODE	SHIP WEIGHT (LBS)	LIST PRICE
Dual Wheel Kit	118333		\$1,274
MulchPower Gauge	117824		\$394

# BRUSH CUTTERS

## GROUND SHARK™ HEAVY DUTY



- Deck steps on both sides to facilitate different carriers with entry on left or right side.
- The hydraulic hoses can be easily rerouted to allow hookup to multiple machine brands.
- Exclusive patented retractable cutting forward shield. When using the Ground Shark on brush/trees that are bigger than 4" in diameter, the shield will retract on its own to allow for maximum performance.
- Serrated Edges on Push Bar and Chassis front corners enable better control when moving material.
- The motor and valve assembly are fully shielded preventing contact with debris.
- Three 5/8" thick bevel edge blades on 66" model and four on 72" model. Forged from top grade steel for excellent cutting in most applications.
- Direct drive motor for efficient performance.
- The Ground Shark line of brush cutters include special hydraulic valving to shut the cutter head down quickly and safely. There is a distinct audible sound during the shutdown which will indicate to the operator that the blades are coming to a stop.
- Bi-directional operation allows operators to utilize both edges of each blade without having to rotate or change blades.
- Optional MulchPower™ gauge is visible to the operator and helps prevent excessive stalling and overheating.
- Blade retention bolt hex shank is design to prevent the bolt from rotating under extreme cutting conditions.
- Bolt on carbide stump grinding teeth increases mulching performance and takes the stump down to ground level.
- .25" thick steel deck design.

	GS66HD			GS72HD		
ORDER CODE	31766-0022	31766-9903	31766-9925	31772-0022	31772-9903	31772-9925
COUPLER SIZE	1/2 IN.	5/8 IN.	3/4 IN.	1/2 IN.	5/8 IN.	3/4 IN.
OVERALL HEIGHT	28.13 IN.	28.13 IN.	28.13 IN.	28.13 IN.	28.13 IN.	28.13 IN.
OVERALL WIDTH	71.13 IN.	71.13 IN.	71.13 IN.	77.13 IN.	77.13 IN.	77.13 IN.
OVERALL LENGTH	81.75 IN.	81.75 IN.	81.75 IN.	85.59 IN.	85.59 IN.	85.59 IN.
CUTTING WIDTH	66 IN.	66 IN.	66 IN.	72 IN.	72 IN.	72 IN.
MINIMUM CUTTING HEIGHT	2.5" IN.	2.5" IN.	2.5" IN.	2.5" IN.	2.5" IN.	2.5" IN.
MINIMUM STUMP GRINDING HEIGHT	.75 IN.	.75 IN.	.75 IN.	.5 IN.	.5 IN.	.5 IN.
CUTTING CAPACITY	7 IN.	7 IN.	7 IN.	7 IN.	7 IN.	7 IN.
DECK THICKNESS	.25 IN.	.25 IN.	.25 IN.	.25 IN.	.25 IN.	.25 IN.
RECOMMENDED FLOW	20-34 GPM	20-34 GPM	20-34 GPM	20-34 GPM	20-34 GPM	20-34 GPM
REQUIRED LIFT CAPACITY	2200 LBS	2200 LBS	2200 LBS	2200 LBS	2200 LBS	2200 LBS
WEIGHT	1605 LBS	1605 LBS	1605 LBS	1800 LBS	1800 LBS	1800 LBS

\*Angled Front Allows Cut to Ground Level

## GROUND SHARK™ HEAVY DUTY CONT.

### GROUND SHARK™ HEAVY DUTY BRUSH CUTTER FOR SKID-STEER LOADERS



**Note:** We highly recommend the purchase of guarding to protect operator and machine from flying debris in harsh forestry and land clearing environments. Please refer to the SSL Forestry Guarding section on page 79 for more information. For Skid-Steer loaders only.

ATTACHES TO SKID-STEER UNIVERSAL HITCH	ORDER CODE	SHIP WEIGHT (LBS)	LIST PRICE
66" Heavy Duty (20-34 GPM) with 1/2" couplers, no case drain	31766-0022	1605	\$13,810
66" Heavy Duty (20-34 GPM) with 5/8" couplers, no case drain	31766-9903	1605	\$14,146
66" Heavy Duty (20-34 GPM) with 3/4" couplers, no case drain	31766-9925	1605	\$13,872
72" Heavy Duty (20-34 GPM) with 1/2" couplers, no case drain	31772-0022	1800	\$14,755
72" Heavy Duty (20-34 GPM) with 5/8" couplers, no case drain	31772-9903	1800	\$14,899
72" Heavy Duty (20-34 GPM) with 3/4" couplers, no case drain	31772-9925	1800	\$14,831

REPLACEMENT PARTS	ORDER CODE	SHIP WEIGHT (LBS)	LIST PRICE
Blade Kit - 66" Model	123735		\$666
Blade Kit - 72" Model	123736		\$825
Carbide Tooth Kit - 66" Model	117193		\$631
Carbide Tooth Kit - 72" Model	123781		\$762
Carbide Tooth - Individual	19917		\$41
Carbide Tooth Nut - Crown Lock UNF	10003		\$3
Skid Shoe Kit - 66" Model	123544		\$209
Skid Shoe Kit - 72" Model	117192		\$225
Hose w/Sock .75x96 12MB-12MB 100R19 HS	38742		\$268
Hose w/Sock .38x112 6FJ-8MB 100R2AT HS	38162		\$118
Hose Coupler .38" body female QD 6 FF F 8FB	84928		POR
Hose Coupler .38" body male QD 6 FF M 8FB	84923		POR
Hose Coupler .50" body female QD 8 FF F 12FB	22518		\$80
Hose Coupler .50" body female QD 8 FF M 12FB	22519		\$55
Hose Coupler .625" body female QD 10 FF F 12FB	84921		\$231
Hose Coupler .625" body male QD 10 FF M 12FB	84922		POR
Hose Coupler .75" body female QD 12 FF F 12FB	22520		\$303
Hose Coupler .75" body male QD 12 FF M 12FB	22521		\$263

OPTIONS	ORDER CODE	SHIP WEIGHT (LBS)	LIST PRICE
MulchPower Gauge	123642		\$603

# BRUSH CUTTERS

## GROUND SHARK™ HIGH PERFORMANCE

**NEW PRODUCT**

BRUSH CUTTERS



- Deck steps on both sides to facilitate different carriers with entry on left or right side.
- The hydraulic hoses can be easily rerouted to allow hookup to multiple machine brands.
- Exclusive patented retractable cutting forward shield. When using the Ground Shark on brush/trees that are bigger than 4" in diameter, the shield will retract on its own to allow for maximum performance.
- Serrated Edges on Push Bar and Chassis front corners enable better control when moving material.
- The motor and valve assembly are fully shielded preventing contact with debris.
- 3 blades 5/8" thick by 5" wide made from high grade abrasive resistant AR400 steel.
- Tri-lobe blade carrier 1" thick high grade steel.
- Blade retention bolt hex shank is design to prevent the bolt from rotating under extreme cutting conditions.
- Standard MulchPower™ gauge is visible to the operator and helps prevent excessive stalling and overheating.
- Bolt-on replaceable skid shoes.
- The Ground Shark line of brush cutters include special hydraulic valving to shut the cutter head down quickly and safely. There is a distinct audible sound during the shutdown which will indicate to the operator that the blades are coming to a stop.
- 84" deck plate constructed of thick .31" grade 50 KPSI thick steel.
- High torque radial piston direct drive hydraulic motor for more efficient power, improved startup and recovery.
- Higher recovery rate than extreme duty models.
- Optimized for horizontal cutting.

	GS72HP			GS84HP		
ORDER CODE	31872-0022	31872-9903	31872-9925	31884-0022	31884-9903	31884-9925
COUPLER SIZE	1/2 IN.	5/8 IN.	3/4 IN.	1/2 IN.	5/8 IN.	3/4 IN.
OVERALL HEIGHT	30.5 IN.	30.5 IN.	30.5 IN.	30.5 IN.	30.5 IN.	30.5 IN.
OVERALL WIDTH	77.13 IN.	77.13 IN.	77.13 IN.	89.13 IN.	89.13 IN.	89.13 IN.
OVERALL LENGTH	89.4 IN.	89.4 IN.	89.4 IN.	98.5 IN.	98.5 IN.	98.5 IN.
CUTTING WIDTH	72 IN.	72 IN.	72 IN.	84 IN.	84 IN.	84 IN.
MINIMUM CUTTING HEIGHT	2.5* IN.	2.5* IN.	2.5* IN.	2.5* IN.	2.5* IN.	2.5* IN.
CUTTING CAPACITY	10 IN.	10 IN.	10 IN.	10 IN.	10 IN.	10 IN.
DECK THICKNESS	.25 IN.	.25 IN.	.25 IN.	.31 IN.	.31 IN.	.31 IN.
RECOMMENDED FLOW	30-45 GPM	30-45 GPM	30-45 GPM	30-40 GPM	30-40 GPM	30-40 GPM
REQUIRED LIFT CAPACITY	2600 LBS	2600 LBS	2600 LBS	3000 LBS	3000 LBS	3000 LBS
WEIGHT	1895 LBS	1895 LBS	1895 LBS	2178 LBS	2178 LBS	2178 LBS

\*Angled Front Allows Cut to Ground Level

## GROUND SHARK™ HIGH PERFORMANCE CONT.

### GROUND SHARK™ HIGH PERFORMANCE BRUSH CUTTER FOR SKID-STEER LOADERS



**Note:** We highly recommend the purchase of guarding to protect operator and machine from flying debris in harsh forestry and land clearing environments. Please refer to the SSL Forestry Guarding section on page 79 for more information. For Skid-Steer loaders only.

ATTACHES TO SKID-STEER UNIVERSAL HITCH	ORDER CODE	SHIP WEIGHT (LBS)	LIST PRICE
72" High Performance (30-45 GPM) with 1/2" couplers, with case drain	31872-0022	1895	\$15,400
72" High Performance (30-45 GPM) with 5/8" couplers, with case drain	31872-9903	1895	\$15,400
72" High Performance (30-45 GPM) with 3/4" couplers, with case drain	31872-9925	1895	\$15,400
84" High Performance (30-40 GPM) with 1/2" couplers, with case drain	31884-0022	2178	\$16,900
84" High Performance (30-40 GPM) with 5/8" couplers, with case drain	31884-9903	2178	\$16,900
84" High Performance (30-40 GPM) with 3/4" couplers, with case drain	31884-9925	2178	\$16,900

REPLACEMENT PARTS	ORDER CODE	SHIP WEIGHT (LBS)	LIST PRICE
Blade Kit - 72" & 84" Models	124686		\$900
Skid Shoe Kit - 72" Model	117192		\$225
Skid Shoe Kit - 84" Model	123343		\$250
Hose w/Sock .75x96 12MB-12MB 100R19 HS	38742		\$268
Hose w/Sock .38x112 6FJ-8MB 100R2AT HS	38162		\$118
Hose Coupler .38" body female QD 6 FF F 8FB	84928		POR
Hose Coupler .38" body male QD 6 FF M 8FB	84923		POR
Hose Coupler .50" body female QD 8 FF F 12FB	22518		\$80
Hose Coupler .50" body female QD 8 FF M 12FB	22519		\$55
Hose Coupler .625" body female QD 10 FF F 12FB	84921		\$231
Hose Coupler .625" body male QD 10 FF M 12FB	84922		POR
Hose Coupler .75" body female QD 12 FF F 12FB	22520		\$303
Hose Coupler .75" body male QD 12 FF M 12FB	22521		\$263

OPTIONS	ORDER CODE	SHIP WEIGHT (LBS)	LIST PRICE
MulchPower Gauge	Included		

# BRUSH CUTTERS

## GROUND SHARK™ EXTREME DUTY

BRUSH CUTTERS



- Deck steps on both sides to facilitate different carriers with entry on left or right side.
- The hydraulic hoses can be easily rerouted to allow hookup to multiple machine brands.
- Exclusive patented retractable cutting forward shield. When using the Ground Shark on brush/trees that are bigger than 4" in diameter, the shield will retract on its own to allow for maximum performance.
- Serrated Edges on Push Bar and Chassis front corners enable better control when moving material.
- The motor and valve assembly are fully shielded preventing contact with debris.
- Bolt-on replaceable skid shoes.
- High torque radial piston direct drive hydraulic motor for more efficient power, improved startup and recovery.
- The Ground Shark line of brush cutters include special hydraulic valving to shut the cutter head down quickly and safely. There is a distinct audible sound during the shutdown which will indicate to the operator that the blades are coming to a stop.
- Four 3/4" thick double bevel reversible edge blades machined from AR400 high strength steel for maximum cutting power and durability.
- Multi-fastener blade retention puck mount. 3 bolts hold puck in place for blade to swivel under extreme conditions.
- Pivoting blades are installed with an alternating blade cut angle. This enables cutting action like a swinging axe which clears the previous cut.
- Bolt-on carbide stump grinding teeth increases mulching performance and takes the stump down to ground level.

	GS72XD			GS78XD		
ORDER CODE	30272-0022	30272-9903	30272-9925	30278-0022	30278-9903	30278-9925
COUPLER SIZE	1/2 IN.	5/8 IN.	3/4 IN.	1/2 IN.	5/8 IN.	3/4 IN.
OVERALL HEIGHT	28.13 IN.	28.13 IN.	28.13 IN.	28.13 IN.	28.13 IN.	28.13 IN.
OVERALL WIDTH	77.13 IN.	77.13 IN.	77.13 IN.	83.13 IN.	83.13 IN.	83.13 IN.
OVERALL LENGTH	85.59 IN.	85.59 IN.	85.59 IN.	91.62 IN.	91.62 IN.	91.62 IN.
CUTTING WIDTH	72 IN.	72 IN.	72 IN.	78 IN.	78 IN.	78 IN.
MINIMUM CUTTING HEIGHT	3.25* IN.	3.25* IN.	3.25* IN.	3.25* IN.	3.25* IN.	3.25* IN.
MINIMUM STUMP GRINDING HEIGHT	.38 IN.	.38 IN.	.38 IN.	.38 IN.	.38 IN.	.38 IN.
CUTTING CAPACITY	10 IN.	10 IN.	10 IN.	10 IN.	10 IN.	10 IN.
DECK THICKNESS	.25 IN.	.25 IN.	.25 IN.	.25 IN.	.25 IN.	.25 IN.
RECOMMENDED FLOW	30-45 GPM	30-45 GPM	30-45 GPM	30-45 GPM	30-45 GPM	30-45 GPM
REQUIRED LIFT CAPACITY	2400 LBS	2400 LBS	2400 LBS	2700 LBS	2700 LBS	2700 LBS
WEIGHT	2008 LBS	2008 LBS	2008 LBS	2267 LBS	2267 LBS	2267 LBS

\*Angled Front Allows Cut to Ground Level

## GROUND SHARK™ EXTREME DUTY CONT.

### GROUND SHARK™ EXTREME DUTY BRUSH CUTTER FOR SKID-STEER LOADERS



**Note:** We highly recommend the purchase of guarding to protect operator and machine from flying debris in harsh forestry and land clearing environments. Please refer to the SSL Forestry Guarding section on page 79 for more information. For Skid-Steer loaders only.

ATTACHES TO SKID-STEER UNIVERSAL HITCH	ORDER CODE	SHIP WEIGHT (LBS)	LIST PRICE
72" Extreme Duty (30-45 GPM) with 1/2" couplers, with case drain	30272-0022	2008	\$17,887
72" Extreme Duty (30-45 GPM) with 5/8" couplers, with case drain	30272-9903	2008	\$18,118
72" Extreme Duty (30-45 GPM) with 3/4" couplers, with case drain	30272-9925	2008	\$17,951
78" Extreme Duty (30-45 GPM) with 1/2" couplers, with case drain	30278-0022	2267	\$18,302
78" Extreme Duty (30-45 GPM) with 5/8" couplers, with case drain	30278-9903	2267	\$18,433
78" Extreme Duty (30-45 GPM) with 3/4" couplers, with case drain	30278-9925	2267	\$18,365

REPLACEMENT PARTS	ORDER CODE	SHIP WEIGHT (LBS)	LIST PRICE
Replacement Blade Kit - 72" & 78" models	117194		\$1,110
Carbide Tooth Kit - 72" model	117193		\$631
Carbide Tooth Kit - 78" model	123734		\$719
Carbide Tooth - Individual	19917		\$41
Carbide Tooth Nut - Crown Lock UNF	10003		\$3
Skid Shoe Kit - 72" model	117192		\$225
Skid Shoe Kit - 78" model	123639		\$241
Hose w/Sock .38x107 6FJ-8MB 100R2AT HS	38665		\$95
Hose w/Sock .75x108 12FJ-12MB 4K HS	37769		\$340
Hose Coupler .38" body female QD 6 FF F 8FB	84928		POR
Hose Coupler .38" body male QD 6 FF M 8FB	84923		POR
Hose Coupler .50" body female QD 8 FF F 12FB	22518		\$80
Hose Coupler .50" body female QD 8 FF M 12FB	22519		\$55
Hose Coupler .625" body female QD 10 FF F 12FB	84921		\$231
Hose Coupler .625" body male QD 10 FF M 12FB	84922		POR
Hose Coupler .75" body female QD 12 FF F 12FB	22520		\$303
Hose Coupler .75" body male QD 12 FF M 12FB	22521		\$263

OPTIONS	ORDER CODE	SHIP WEIGHT (LBS)	LIST PRICE
MulchPower Gauge	Included		

# BRUSH CUTTERS

## SSL GUARDING PACKAGES



**Note: We highly recommend the purchase of guarding to protect operator and machine from flying debris in harsh forestry and land clearing environments. For Skid-Steer loaders only.**

	ORDER CODE	SHIP WEIGHT (LBS)	LIST PRICE
<b>SSL/CTL</b>			
Universal Front Shield	W08290000		POR



## KUBOTA GUARDING PACKAGE

	ORDER CODE	SHIP WEIGHT (LBS)	LIST PRICE
<b>Model SVL95-2</b>			
Complete Package: Top Guard, Working Light, Rear Grille Guard and Hyd Connection	WF8CFSVL2001		POR
Top Guard Kit, KU SVL Series	WF8290000		POR
Working Light Kit (FR/RR)	WF8290020		POR
Rear Grille Guard. KU SVL95-2	WF8290010		POR
Hydraulic Connection Guard Kit	WF8290030		POR
<b>SSL SVL95-2s</b>			
Def Cover, Kit, KU, SVL95-2S			POR
<b>Kubota Excavator Cab Guarding</b>			
Front Window Guard - Wire, KA KXX080-4, Enclosed Cab	WF1290060		POR

Add Surcharge to all products 8.85%

## FORESTRY GUARDING PACKAGES



### HYDRAULIC CONNECTION GUARDS

Heavy-duty formed 3/16" steel plate. Easy bolt-on installation – no welding. Complete Connect Under Pressure (CUP) manifold protection. Hinged guards for CUP manifold access.



### REAR BUMPER

Heavy-duty formed steel plate construction. Bolt-on design requires no welding. Does not interfere with OEM tie-down hook access or compartment doors. Departure angle of 21°



### REAR GRILL GUARD

Attaches to heavy duty rear bumper. Upper mounts weld to frame. Heavy-duty design protects radiator from debris while allowing ample airflow. Swings open to allow unhindered access to engine compartment.



### SWEEP

Protects rear of machine from falling debris. Tool-less opening from the inside and out and hinges up for emergency egress.



### TOP GUARD WITH LIGHT GUARDS

Supported by cab frame and held in place using existing rivnuts. Maintains top window visibility. Low profile design to avoid tree limbs. Includes light guards.



### INTAKE SCREENS

Filters debris from entering air cooler area. Helps prevent overheating issues and prolongs life of coolers. Bolt-on (hole modification required), no welding required. Replaceable steel mesh screen design.



### SIDE SCREENS

Heavy duty design to protect cab glass. Replaces OEM side screens for use in harsh environments.

## CASE FORESTRY GUARDING PACKAGES

	ORDER CODE	SHIP WEIGHT (LBS)	LIST PRICE
<b>Case SV300, SV340 &amp; TV380 Tier 4B</b>			
Hydraulic connection guards, FG	W28190000		POR
Assembly, rear bumper, SSL, FG	W28190010		POR
Rear grill guard, CS SSL/CTL T4F, FG	W28190060		POR
Sweep kit, CS CTL/SSL, 90HP T4F, FG	W28190070		POR
Top guard w light guards, FG	W28190040		POR
Additional intake screens, SV300, FG	W28190050		POR
Side screen kit, CS SSL/CTL T4F, FG	W28290000		POR

# BRUSH CUTTERS

## MX SERIES BRUSH CUTTER



- No-case-drain design and universal bolt-on mounting system means maximum fleet versatility for end-users and rental fleet owners
- Hinged debris shield provides the aggressive, full-depth cutting action of an open-deck design while limiting operator exposure to flying debris
- Patent-pending TiltLatch™ ensures debris shield stays closed with cutter is overhead, ensuring operator safety even in extreme-reach situations

Model	Machine Weight	Lift Capacity Required	Flow* (GPM)	Cutting Width	Max. Brush Size	Adapter Pattern
BC40MX10	3-6mT	700+ lbs	13-19	40"	4"	A
BC40MX20			19-26			
BC50MX10	5-8mT	1,140+ lbs	17-22	50"	5"	B or C
BC50MX20			22-34			
BC60MX10	7-10mT	1,440 lbs	20-28	60"	6"	B or C
BC60MX20			28-35			

\*Flow shown is the required auxiliary flow to power the cutter, not the total machine flow

## MX SERIES 40", 50" & 60" BRUSH CUTTER FOR MINI-EXCAVATORS



	DIMENSIONS**	ORDER CODE	WEIGHT** (LBS)	LIST PRICE
BC40MX10, no case drain	47" x 52" x 22"	125140A-BLNK	660	\$9,392
BC40MX20, no case drain	47" x 52" x 22"	125140B-BLNK	660	\$9,392
BC50MX10, no case drain	57" x 63" x 24"	125150A-BLNK	1,050	\$12,420
BC50MX20, no case drain	57" x 63" x 24"	125150B-BLNK	1,050	\$12,420
BC60MX10, no case drain	67" x 73" x 26"	125160A-BLNK	1,240	\$13,885
BC60MX20, no case drain	67" x 73" x 26"	125160B-BLNK	1,240	\$13,885

\*\*Does not include pallet and other shipping dunnage.

ACCESSORIES	ORDER CODE	SHIP WEIGHT (LBS)	LIST PRICE
Double-bevel AR400 replacement blade kit (fits all models)	125090		\$645
Debris curtain replacement kit for 40" MX models	125132		\$275
Debris curtain replacement kit for 50" MX models	125133		\$331
Debris curtain replacement kit for 60" MX models	125134		\$371

TOP CAPS - "A" PATTERN	ORDER CODE	SHIP WEIGHT (LBS)	LIST PRICE
ASSY MTG TOP CAP A PATTERN F/BOBCAT MT55	28-11090-0128		\$1,038
ASSY MTG TOP CAP SF CORE 03T 30MM PIN	28-11090-03030		\$957
ASSY MTG TOP CAP SF CORE 03T 35MM PIN	28-11090-03035		\$977
ASSY MTG TOP CAP SF CORE 03T 40MM PIN	28-11090-03040		\$985
ASSY MTG TOP CAP A PATTERN F/DINGO	28-11090-0961		\$1,127
ASSY MTG TOP CAP A PATTERN F/TAK TB210R	28-11090-E0007		\$1,112
ASSY MTG TOP CAP A PATTERN F/YAN VIO17-A	28-11090-E0017		\$1,267

EXCAVATOR AUGERS ACCESSORIES CONTINUED NEXT PAGE

## MX SERIES BRUSH CUTTER CONT.

TOP CAPS - "A" PATTERN	ORDER CODE	SHIP WEIGHT (LBS)	LIST PRICE
ASSY MTG TOP CAP A PATTERN F/YANMAR	28-11090-E0030		\$1,619
ASSY MTG TOP CAP A PATTERN F/KUB KX41	28-11090-E0043		\$1,460
ASSY MTG TOP CAP A PATTERN F/KOMATSU	28-11090-E0046		\$1,052
ASSY MTG TOP CAP A PATTERN F/YANMAR	28-11090-E0050		\$1,172
ASSY MTG TOP CAP A PATTERN F/KUBOTA	28-11090-E0091		\$1,658
ASSY MTG TOP CAP A PATTERN F/KUBOTA K008	28-11090-E0117		\$1,226
ASSY MTG TOP CAP A PATTERN F/KUB B26	28-11090-E0126		POR
ASSY MTG TOP CAP A PATTERN F/NH EC17	28-11090-E0179		\$993
ASSY MTG TOP CAP A PATTERN F/WN 3503	28-11090-E0223		\$1,059
ASSY MTG TOP CAP A PATTERN F/JD 35G	28-11090-E0228		\$976
ASSY MTG TOP CAP A PATTERN F/CASE CX26C	28-11090-E0259		\$2,105
ASSY MTG TOP CAP A PATTERN F/KOMATSU	28-11090-E0418		\$1,052
ASSY MTG TOP CAP A PATTERN F/CASE CX37C	28-11090-E0535		\$1,127
ASSY MTG TOP CAP A PATTERN F/HYUNDAI	28-11090-E0809		\$3,105
ASSY MTG TOP CAP A PATTERN CP 027 QH	28-11090-E0852		\$1,127
ASSY MTG TOP CAP A PATTERN F/KUBOTA	28-11090-E1043		\$1,150
ASSY MTG TOP CAP A PATTERN F/VOLVO ECR58	28-11090-E1056		\$1,306
ASSY MTG TOP CAP A PATTERN F/KUBOTA	28-11090-E1090		\$1,158
ASSY MTG TOP CAP A PATTERN F/KUBOTA	28-11090-E1091		\$1,123
ASSY MTG TOP CAP A PATTERN F/KUBOTA	28-11090-E1117		\$1,156
ASSY MTG TOP CAP A PATTERN F/JD 17 ZTS	28-11090-E2017		\$1,016
ASSY MTG TOP CAP A PATTERN F/SANY SY26	28-11090-E3026		\$1,297
ASSY MTG TOP CAP A PATTERN F/BOBCAT	28-11090-E3055		\$3,052
ASSY MTG TOP CAP TWC500 F/CAT 301.7D	28-11090-E3301		\$1,482
ASSY MTG TOP CAP A PATTERN F/CAT 302.5C	28-11090-E3302		\$1,582
ASSY MTG TOP CAP A PATTERN F/CAT 303.5E	28-11090-E3303		\$1,028
ASSY MTG TOP CAP A PATTERN F/BRADCO 365	28-11090-E4365		POR
ASSY MTG TOP CAP A PATTERN F/JD 35G	28-11090-E5035		\$1,019
ASSY MTG TOP CAP A PATTERN F/SANY SY35	28-11090-E6035		\$1,579
ASSY MTG TOP CAP A PATTERN F/JCB 8018	28-11090-E8018		POR
ASSY MTG TOP CAP A PATTERN F/KUBOTA	28-11090-R1970		\$1,121

TOP CAPS - "B" PATTERN	ORDER CODE	SHIP WEIGHT (LBS)	LIST PRICE
ASSY MTG TOP CAP B PATTERN 9 IN CTR	28-11091		POR
ASSY MTG TOP CAP B PATTERN F/BOBCAT	28-11091-0128		\$1,458
ASSY MTG TOP CAP SF CORE 05T 30MM PIN	28-11091-05030		\$908
ASSY MTG TOP CAP SF CORE 05T 35MM PIN	28-11091-05035		\$1,123
ASSY MTG TOP CAP SF CORE 05T 40MM PIN	28-11091-05040		\$996
ASSY MTG TOP CAP SF CORE 05T 45MM PIN	28-11091-05045		\$1,044
ASSY MTG TOP CAP B PATTERN F/DINGO	28-11091-0961		\$1,166
ASSY MTG TOP CAP B PATTERN F/AVANT QA	28-11091-0994		POR
ASSY MTG TOP CAP B PATTERN F/YANMAR	28-11091-E0017		\$1,145

EXCAVATOR AUGERS ACCESSORIES CONTINUED NEXT PAGE

# BRUSH CUTTERS

## MX SERIES BRUSH CUTTER CONT.

BRUSH CUTTERS

TOP CAPS - "B" PATTERN	ORDER CODE	SHIP WEIGHT (LBS)	LIST PRICE
ASSY MTG TOP CAP B PATTERN F/YANMAR	28-11091-E0030		\$1,769
ASSY MTG TOP CAP B PATTERN F/YANMAR	28-11091-E0050		\$1,509
ASSY MTG TOP CAP B PATTERN F/TAK TB235	28-11091-E0135		\$1,408
ASSY MTG TOP CAP B PATTERN F/JD 50G ZTS	28-11091-E0153		\$1,232
ASSY MTG TOP CAP B PATTERN F/NH EC17	28-11091-E0179		\$1,249
ASSY MTG TOP CAP B PATTERN F/JD 35 ZTS	28-11091-E0228		\$1,165
ASSY MTG TOP CAP B PATTERN F/JD 26G	28-11091-E0229		POR
ASSY MTG TOP CAP B PATTERN F/CASE CX26C	28-11091-E0259		\$1,986
ASSY MTG TOP CAP B PATTERN F/CAT 304CCR	28-11091-E0304		\$1,721
ASSY MTG TOP CAP B PATTERN CP 030 QH	28-11091-E0333		\$1,764
ASSY MTG TOP CAP B PATTERN CP 027 QH	28-11091-E0852		\$1,165
ASSY MTG TOP CAP B PATTERN F/SANY SY16	28-11091-E1016		POR
ASSY MTG TOP CAP B PATTERN F/JCB 55Z	28-11091-E1057		\$1,373
ASSY MTG TOP CAP B PATTERN F/CASE CX60C	28-11091-E1060		\$1,460
ASSY MTG TOP CAP B PATTERN F/KUBOTA	28-11091-E1090		\$1,045
ASSY MTG TOP CAP B PATTERN F/KUBOTA	28-11091-E1091		\$1,168
ASSY MTG TOP CAP B PATTERN F/BOBCAT E45	28-11091-E1450		\$1,154
ASSY MTG TOP CAP B PATTERN F/BOBCAT E35	28-11091-E1535		\$1,270
ASSY MTG TOP CAP B PATTERN F/JD 17G ZTS	28-11091-E2017		\$967
ASSY MTG TOP CAP B PATTERN F/SANY SY10	28-11091-E2510		POR
ASSY MTG TOP CAP B PATTEF/BOBCAT X-CHNGE	28-11091-E3055		\$2,739
ASSY MTG TOP CAP B PATTERN F/CAT 303.5E	28-11091-E3303		\$1,449
ASSY MTG TOP CAP B PATTERN F/TEREX TX16	28-11091-E4015		\$1,237
ASSY MTG TOP CAP B PATTERN F/KUBOTA	28-11091-E5057		\$1,142
ASSY MTG TOP CAP B PATTERN F/SANY SY35U	28-11091-E6035		\$1,411
ASSY MTG TOP CAP B PATTERN F/SANY SY60	28-11091-E6060		\$1,342
ASSY MTG BREAKER B PATTERN F/JD 60P	28-11091-E7060		\$1,615
ASSY MTG TOP CAP B PATTERN F/SANY SY50	28-11091-E8050		POR
ASSY MTG TOP CAP B PATTERN F/JCB 210	28-11091-R0210		\$967
ASSY MTG TOP CAP B PATTERN F/NH B110B	28-11091-R3110		\$2,677
ASSY MTG TOP CAP B PATTERN F/NH B90B	28-11091-R3555		\$2,259

TOP CAPS - "C" PATTERN	ORDER CODE	SHIP WEIGHT (LBS)	LIST PRICE
ASSY MTG TOP CAP C PATTERN SF CORE 08T	28-10973-08035		\$1,741
ASSY MTG TOP CAP C PATTERN SF CORE 08T	28-10973-08040		\$2,023
ASSY MTG TOP CAP C PATTERN SF CORE 08T	28-10973-08045		\$2,103
ASSY MTG TOP CAP C PATTERN SF CORE 08T	28-10973-08050		\$1,923
ASSY MTG TOP CAP C PATTERN SF CORE 09T	28-10973-09045		\$1,760
ASSY MTG TOP CAP C PATTERN SF CORE 09T	28-10973-09050		\$1,741
ASSY MTG TOP CAP C PATTERN F/ YAN VIO35	28-10973-E0030		\$2,308
ASSY MTG TOP CAP C PATTERN F/ WN EZ38	28-10973-E0038		POR
ASSY MTG TOP CAP C PATTERN F/TAK TB250	28-10973-E0045		\$2,214
ASSY MTG TOP CAP C PATTERN F/KOMATSU	28-10973-E0046		\$1,761
ASSY MTG TOP CAP C PATTERN F/ YAN VIO45	28-10973-E0050		\$1,810

EXCAVATOR AUGERS ACCESSORIES CONTINUED NEXT PAGE

## MX SERIES BRUSH CUTTER CONT.

TOP CAPS - "C" PATTERN	ORDER CODE	SHIP WEIGHT (LBS)
ASSY MTG TOP CAP C PATTERN F/KOM PC78	28-10973-E0060	\$1,998
ASSY MTG TOP CAP C PATTERN F/ TAK TB285	28-10973-E0071	\$2,219
ASSY MTG TOP CAP C PATTERN F/JD 85G	28-10973-E0081	\$1,630
ASSY MTG TOP CAP C PATTERN F/TAK TB135	28-10973-E0135	\$1,516
ASSY MTG TOP CAP C PATTERN F/JD 50G ZTS	28-10973-E0153	\$1,788
ASSY MTG TOP CAP C PATTERN F/WN EZ38	28-10973-E0223	\$1,895
ASSY MTG TOP CAP C PATTERN F/JD 35D ZTS	28-10973-E0228	\$1,821
ASSY MTG TOP CAP C PATTERN F/NH E30C	28-10973-E0259	\$1,433
ASSY MTG TOP CAP C PATTERN F/CAT 305E	28-10973-E0304	\$1,809
ASSY MTG TOP CAP C PATTERN F/CP 030	28-10973-E0333	\$1,866
ASST MTG TOP CAP C PATTERN F/ WN EZ53	28-10973-E0503	\$1,835
ASSY MTG TOP CAP C PATTERN F/JCB 8035	28-10973-E0803	POR
ASSY MTG TOP CAP C PATTERN F/ CP 027	28-10973-E0852	\$1,516
ASSY MTG TOP CAP C PATTERN F/WAIN-ROY	28-10973-E0957	\$1,901
ASSY MTG TOP CAP C PATTERN F/VOLVO ECR58	28-10973-E1056	\$1,698
ASSY MTG TOP CAP C PATTERN F/JCB 55Z	28-10973-E1057	\$2,127
ASSY MTG TOP CAP C PATTERN F/CASE CX60C	28-10973-E1060	\$1,831
ASSY MTG TOP CAP C PATTERN F/KUB K7974	28-10973-E1090	\$1,776
ASSY MTG TOP CAP C PATTERN F/KUB K7870	28-10973-E1091	\$2,127
ASSY MTG TOP CAP C PATTERN F/KOM WB150	28-10973-E1140	POR
ASSY MTG TOP CAP C PATTERN F/KUB K7880	28-10973-E1151	\$1,776
ASSY MTG TOP CAP C PATTERN F/YAN VIO80	28-10973-E1171	\$2,033
ASSY MTG TOP CAP D PATTERN F/DOOSAN DX50	28-10973-E1450	\$1,619
ASSY MTG TOP CAP C PATTERN F/CASE CX80	28-10973-E1600	\$2,132
ASSY MTG TOP CAP C PATTERN F/TAK TB230	28-10973-E2026	POR
ASSY MTG TOP CAP C PATTERN F/IHI 35NX	28-10973-E2035	\$1,735
ASSY MTG TOP CAP C PATTERN F/CASE CX50B	28-10973-E2051	\$1,735
ASSY MTG TOP CAP C PATTERN F/KOB SLQT	28-10973-E2070	\$1,787
ASSY MTG TOP CAP C PATTERN F/KUB K9930	28-10973-E2091	\$1,768
ASSY MTG TOP CAP C PATTERN F/TAKEUCHI	28-10973-E2260	\$2,155
ASSY MTG TOP CAP C PATTERN F/BOB X-CNG	28-10973-E3055	\$2,961
ASSY MTG TOP CAP C PATTERN F/CAT 303.5E	28-10973-E3303	\$1,794
ASSY MTG TOP CAP C PATTERN F/CAT 304 CR	28-10973-E3304	\$1,761
ASSY MTG TOP CAP C PATTERN F/CASE CX36B	28-10973-E3354	\$1,821
ASSY MTG TOP CAP C PATTERN F/VOLVO ECR38	28-10973-E4035	\$1,856
ASSY MTG TOP CAP C PATTERN F/KUB K7402	28-10973-E4080	\$1,856
ASSY MTG TOP CAP C PATTERN F/JD 50G/60G	28-10973-E5050	\$1,692
ASSY MTG TOP CAP C PATTERN F/ KUB KX057	28-10973-E5055	\$2,072
ASSY MTG TOP CAP C PATTERN F/KUBOTA	28-10973-E5056	\$1,901
ASSY MTG TOP CAP C PATTERN F/KUB KX057	28-10973-E5057	\$1,957
ASSY MTG TOP CAP C PATTERN F/KUB K9940	28-10973-E5059	\$1,761
ASSY MTG TOP CAP C PATTERN F/KUBOTA	28-10973-E5080	POR
ASSY MTG TOP CAP C PATTERN F/SANY SY35U	28-10973-E6035	\$1,990
ASSY MTG TOP CAP C PATTERN F/JD 60G***	28-10973-E7065	POR
ASSY MTG TOP CAP C PATTERN F/SANY SY50	28-10973-E8050	\$1,761
ASSY MTG TOP CAP C PATTERN F/SANY SY95	28-10973-E8095	POR

# BRUSH CUTTERS

## MX SERIES BRUSH CUTTER CONT.

BRUSH CUTTERS

TOP CAPS - "C" PATTERN	ORDER CODE	SHIP WEIGHT (LBS)
ASSY MTG TOP CAP C PATTERN F/SANY SY35U	28-10973-E8935	POR
ASSY MTG TOP CAP C PATTERN F/JD 310L	28-10973-R0009	\$1,995
ASSY MTG TOP CAP C PATTERN F/JD 310 SL	28-10973-R0010	\$2,872
ASSY MTG TOP CAP C PATTERN F/JCB 214	28-10973-R0214	\$3,321
ASSY MTG TOP CAP C PATTERN F/CASE 580M/	28-10973-R0580	\$2,330
ASSY MTG TOP CAP C PATTERN F/CASE***	28-10973-R2580	POR
ASSY MTG TOP CAP C PATTERN F/NH LB 95B	28-10973-R3555	\$2,693
ASSY MTG TOP CAP C PATTERN F/CASE 580 SN	28-10973-R3580	\$2,798

Add Surcharge to all products 8.85%

# BUCKETS



# BUCKETS

BUCKETS



Paladin Attachments has a variety of buckets to suit your needs. From light material buckets to heavy duty material buckets to special purpose buckets, our attachments can increase your productivity - saving you time and money.

Since many of our buckets are customized to your needs, when you place your order you will need to choose your bucket, the mounting, hydraulic kit (if needed), and any options you would like. As you look through the products, notice the red headings in the charts - they will alert you to the choices you need to make.

Choose your bucket - be sure to check loader capacity before ordering

BUCKET		ORDER CODE	SHIP WEIGHT (LBS)
CHECK LOADER CAPACITY BEFORE ORDERING			
<b>(75 degree back)</b>			
73" OD Construction 4-in-1		LAF0976	1390
78" OD Construction 4-in-1		LAF0977	1475
82" OD Construction 4-in-1		LAF0985	1540
87" OD Construction 4-in-1		LAF0990	1620
<b>(Designed for Track Machines)</b>			
84" OD Construction 4-in-1 (70° back)		LAF0988	1343
90" OD Construction 4-in-1 (70° back)		LAF0992	1434

LIST PRICE of loader mounting must be added to the attachment LIST PRICE

Choose a mount

MOUNTING		ORDER CODE	SHIP WEIGHT (LBS)
ADDITIONAL COST MAY APPLY			
Contact Customer Service at (833) 723-1843			

Decide what options you want

OPTIONS		ORDER CODE	SHIP WEIGHT (LBS)
EXCLUSIVE TO FFC BUCKETS			
<b>Extra Heavy-Duty Toothbar for Buckets with Bolt-On Edge</b>			
For Bucket LAF0976 with 8 teeth		LAF9173-FF41	
For Bucket LAF0977 with 9 teeth		LAF9179-FF41	
For Bucket LAF0985 with 9 teeth		LAF9183-FF41	
For Bucket LAF0988		10640	
For Bucket LAF0992		10641	

Be sure to look for the warning symbol- this box contains important information pertaining to that particular bucket and how it will attach to your prime mover



**IMPORTANT: FFC Skid-Steer buckets have a 70° angle on the back. This may increase or decrease the effective rollback and dump angles of your Skid-Steer. Specify Skid-Steer make and model when ordering.**

If you have any questions about placing your order, contact Customer Service at (833) 723-1843.

## LOW-PROFILE LONG FLOOR BUCKET



- 36" long floor buckets for better visibility, productivity and cutting grade
- High strength side cutters tie into the front edge for better strength and longer life

## LOW-PROFILE LONG FLOOR BUCKETS FOR SKID-STEER LOADERS



	ORDER CODE	SHIP WEIGHT (LBS)	LIST PRICE
60" bucket (15.8 ft <sup>3</sup> ) 7 holes/9" spacing	15111	467	\$1,563
60" bucket with 6 teeth	33862	510	\$1,824
63" bucket 9 holes/7" spacing	33808	426	\$1,563
63" bucket LPLF, bolt on tooth ready	121592	567	\$1,898
66" bucket (17.5 ft <sup>3</sup> ) 7 holes/10" spacing	15115	500	\$1,603
66" bucket with 7 teeth	33866	550	\$1,959
68" bucket (18.4 ft <sup>3</sup> ) 7 holes/10" spacing	115925	490	\$1,555
68" bucket with 8 teeth	115926	548	\$1,832
68" bucket LPLF, bolt on tooth ready	121603	506	\$1,386
72" bucket (19.2 ft <sup>3</sup> ) 7 holes/11" spacing	15117	533	\$1,689
72" bucket with 8 teeth	33868	590	\$1,963
75" bucket LPLF, bolt on tooth ready	121742	576	\$1,697
78" bucket (20.9 ft <sup>3</sup> ) 9 holes/9" spacing	16271	608	\$2,062
78" bucket with 8 teeth	16266	665	\$2,284
80" bucket LPLF, bolt on tooth ready	121737	704	\$3,467
82" bucket (22.0 ft <sup>3</sup> ) 9 holes/9.75" spacing	15119	631	\$2,203
82" bucket with 9 teeth	33870	695	\$2,415
84" bucket (22.7 ft <sup>3</sup> ) 9 holes/9.75" spacing	16181	641	\$2,191
84" bucket with 9 teeth	16191	705	\$2,402
84" bucket LPLF, bolt on tooth ready	121745	728	\$3,523



## "DIRT-READY" LOW-PROFILE LONG FLOOR BUCKETS FOR SKID-STEER LOADERS

"DIRT READY" BUCKETS INCLUDE SIDE CUTTERS AND EITHER BOE OR TEETH	ORDER CODE	SHIP WEIGHT (LBS)	LIST PRICE
60" bucket LPLF w/BOE and side cutters	KD15111	816	\$2,062
60" bucket LPLF w/teeth and side cutters	KD33862	767	\$1,952
63" bucket LPLF w/BOE and side cutters	KD33808	575	\$2,150
66" bucket LPLF w/BOE and side cutters	KD15115	741	\$2,214
66" bucket LPLF w/teeth and side cutters	KD33866	696	\$2,052
68" bucket LPLF w/BOE and side cutters	KD111712	680	\$2,160
68" bucket LPLF w/teeth and side cutters	KD111713	628	\$1,970
72" bucket LPLF w/teeth and side cutters	KD113903	650	\$2,084
72" bucket LPLF w/BOE and side cutters	KD113902	710	\$2,084
72" bucket LPLF w/teeth	KD118653	618	\$2,015

"DIRT-READY" LOW-PROFILE LONG FLOOR BUCKETS CONTINUED ON NEXT PAGE

# BUCKETS

BUCKETS

## LOW-PROFILE LONG FLOOR BUCKET CONT. "DIRT-READY" LOW-PROFILE LONG FLOOR BUCKETS FOR SKID-STEER LOADERS

"DIRT READY" BUCKETS INCLUDE SIDE CUTTERS AND EITHER BOE OR TEETH	ORDER CODE	SHIP WEIGHT (LBS)	LIST PRICE
75" bucket LPLF w/teeth	KD118662	650	\$2,150
75" bucket LPLF w/BOE and side cutters	121487	778	\$2,349
75" bucket LPLF w/teeth and side cutters	125924	765	\$2,280
78" bucket LPLF w/BOE and side cutters	KD16271	710	\$2,530
78" bucket LPLF w/teeth and side cutters	KD16266	680	\$2,296
80" bucket LPLF w/BOE and side cutters	KD111754	798	\$2,630
80" bucket LPLF w/teeth and side cutters	KD111755	740	\$2,390
82" bucket LPLF w/BOE and side cutters	KD15119	795	\$2,828
82" bucket LPLF w/teeth and side cutters	KD33870	752	\$2,445
84" bucket LPLF w/BOE and side cutters	KD16181	954	\$2,662
84" bucket LPLF w/teeth and side cutters	KD16191	924	\$2,496
90" bucket LPLF w/teeth & side cutters	239641	800	\$2,750
90" bucket LPLF w/BOE and side cutters	239642	815	\$3,150
96" bucket LPLF w/teeth & side cutters	239665	845	\$2,850
96" bucket LPLF w/BOE and side cutters	239666	860	\$3,250

## LOW-PROFILE STANDARD FLOOR BUCKET



- 30" standard floor buckets
- High strength side cutters tie into the front edge for better strength and longer life



## LOW-PROFILE STANDARD FLOOR BUCKETS FOR SKID-STEER LOADERS

	ORDER CODE	SHIP WEIGHT (LBS)	LIST PRICE
60" bucket (12.7 ft <sup>3</sup> ) 7 holes/9" spacing	15120	412	\$1,528
60" bucket with 6 teeth	33861	455	\$1,782
63" bucket 9 holes/7" spacing	33807	426	\$1,546
63" bucket LPSF, bolt on tooth ready	121596	464	\$1,804
66" bucket (14.1 ft <sup>3</sup> ) 7 holes/10" spacing	15114	440	\$1,567
66" bucket with 7 teeth	33865	490	\$1,844
68" bucket (14.8 ft <sup>3</sup> ) 7 holes/10" spacing	115923	451	\$1,595
68" bucket with 8 teeth	115924	509	\$1,880
68" bucket LPSF, bolt on tooth ready	121599	465	\$1,740
72" bucket (15.4 ft <sup>3</sup> ) 7 holes/11" spacing	15116	473	\$1,650
72" bucket with 8 teeth	33867	530	\$1,883
75" bucket LPSF, bolt on tooth ready	121756	634	\$2,006
78" bucket (16.7 ft <sup>3</sup> ) 9 holes/9" spacing	16270	543	\$2,014
78" bucket with 8 teeth	16265	600	\$2,230

LOW-PROFILE STANDARD FLOOR BUCKETS CONTINUED ON NEXT PAGE

## LOW-PROFILE STANDARD FLOOR BUCKET CONT.

### LOW-PROFILE STANDARD FLOOR BUCKETS FOR SKID-STEER LOADERS CONT.



	ORDER CODE	SHIP WEIGHT (LBS)	LIST PRICE
80" bucket LPSF, bolt on tooth ready	121606	560	\$3,373
82" bucket (17.6 ft <sup>3</sup> ) 9 holes/9.75" spacing	15118	566	\$2,151
82" bucket with 9 teeth	33869	630	\$2,359
84" bucket (18.1 ft <sup>3</sup> ) 9 holes/9.75" spacing	16180	576	\$2,380
84" bucket with 9 teeth	16190	640	\$2,199
84" bucket LPSF, bolt on tooth ready	121759	683	\$3,506

### "DIRT READY" LOW-PROFILE STANDARD FLOOR BUCKETS FOR SKID-STEER LOADERS

"DIRT READY" BUCKETS INCLUDE SIDE CUTTERS AND EITHER BOE OR TEETH	ORDER CODE	SHIP WEIGHT (LBS)	LIST PRICE
60" bucket LPSF w/BOE and side cutters	KD15120	522	\$2,062
60" bucket LPSF w/teeth and side cutters	KD33861	473	\$1,942
63" bucket LPSF w/BOE and side cutters	KD33807	661	\$2,150
66" bucket LPSF w/BOE and side cutters	KD15114	695	\$2,176
66" bucket LPSF w/teeth and side cutters	KD33865	651	\$1,933
68" bucket LPSF w/BOE and side cutters	KD111813	642	\$2,087
68" bucket LPSF w/teeth and side cutters	KD111814	588	\$1,951
72" bucket LPSF w/BOE and side cutters	KD113900	669	\$2,212
72" bucket LPSF w/teeth	KD118652	587	\$1,909
72" bucket LPSF w/teeth and side cutters	KD113901	608	\$2,068
75" bucket LPSF	KD118685	685	\$1,538
75" bucket LPSF w/teeth	KD118686	743	\$2,050
78" bucket LPSF w/BOE and side cutters	KD16270	792	\$2,477
78" bucket LPSF w/teeth and side cutters	KD16265	751	\$2,243
80" bucket LPSF w/BOE and side cutters	KD111838	760	\$2,544
80" bucket LPSF w/teeth and side cutters	KD111839	696	\$2,224
84" bucket LPSF w/BOE and side cutters	KD16180	916	\$2,670
84" bucket LPSF w/teeth and side cutters	KD16190	780	\$2,418

Add Surcharge to all products 8.85%

# BUCKETS

## BUCKET ACCESSORIES FOR BRADCO LOW-PROFILE, HIGH CAPACITY BUCKETS

	ORDER CODE	SHIP WEIGHT (LBS)	LIST PRICE
<b>Extreme-Duty Bucket Options</b>			
Bolt-on side cutter assembly (pair) (shown)	107786	18	\$148
Assembly charge to attach bucket edge at factory (net cost per each unit assembled)			
<b>Bolt-On Edge Assembly</b>			
60" (7 holes, 9" spacing)	15025	124	\$535
63" (7 holes, 9.63" spacing)*	121762	102	\$590
63" (9 holes, 7" spacing)	33816	106	\$502
66" (7 holes, 10" spacing)	15027	110	\$550
68" (7 holes, 10" spacing)	111726	110	\$546
68" (7 holes, 10.59" spacing)**	121763	111	\$516
72" (7 holes, 11" spacing)	15028	120	\$552
72" (12 holes, 6" spacing)	33818	121	\$555
75" (8 holes, 10" spacing)	18880	125	\$680
75" (8 holes, 9.94" spacing)¥	121764	122	\$530
78" (9 holes, 9" spacing)	16204	130	\$700
80" (7 holes, 12" spacing)	89578	132	\$710
80" (8 holes, 10.81" spacing)€	121765	130	\$757
82" (9 holes, 9.75" spacing)	15029	136	\$730
82" (10 holes, 8" spacing)	33819	136	\$679
84" (9 holes, 9.75" spacing)Σ	16183	203	\$715
96" (9 holes, 10.83" spacing)	11002	160	\$800
<b>Tooth Bar Assembly</b>			
Bucket tooth assembly bolt on with hardware (use with bolt on tooth buckets)	121672	-	\$68
Side Cutter Kit, bolt on option	107786	-	\$148
60" side cutter mounting tooth bar assembly (standard)	112890	83	\$808
60" over the edge side cutter mounting tooth bar (over bolt-on edge)	112900	105	\$727
63" side cutter mounting tooth bar assembly (standard)*	112892	92	\$884
63" over the edge side cutter mounting tooth bar (over bolt-on edge)	112902	117	\$1,169
66" side cutter mounting tooth bar assembly (standard)	112894	93	\$947
66" over the edge side cutter mounting tooth bar (over bolt-on edge)	112904	119	\$1,646
68" side cutter mounting tooth bar assembly (standard)**	113380	94	\$998
68" over the edge side cutter mounting tooth bar (over bolt-on edge)	113381	127	\$1,126
72" side cutter mounting tooth bar assembly (standard)	110738	100	\$1,060
72" over the edge side cutter mounting tooth bar (over bolt-on edge)	110744	130	\$1,603
75" side cutter mounting tooth bar assembly (standard)	112771	106	\$1,004
75" over the edge side cutter mounting tooth bar (over bolt-on edge)	112773	132	\$1,423
75" side cutter mounting tooth bar assembly (standard)¥	121767	103	\$1,092
78" side cutter mounting tooth bar assembly (standard)	110740	109	\$1,212
78" over the edge side cutter mounting tooth bar (over bolt-on edge)	110746	132	\$1,476
80" side cutter mounting tooth bar assembly (standard)	112896	114	\$1,023
<b>TOOTH BAR ASSEMBLY CONTINUED ON NEXT PAGE</b>			



\*use with 121596, 121592, 121748  
 \*\*use with 121599, 121603, 121753  
 ¥ use with 121756, 121742, 121680  
 € use with 121606, 121737, 121654  
 Σ use with 121759, 121745, 121674

## BUCKET ACCESSORIES FOR BRADCO LOW-PROFILE, HIGH CAPACITY BUCKETS CONT.

	ORDER CODE	SHIP WEIGHT (LBS)	LIST PRICE
<b>Tooth Bar Assembly cont.</b>			
80" over the edge side cutter mounting tooth bar (over bolt-on edge)	112906	137	\$1,505
80" side cutter mounting tooth bar assembly (standard)€	121768	140	\$1,100
82" side cutter mounting tooth bar assembly (standard)	112898	129	\$1,526
82" over the edge side cutter mounting tooth bar (over bolt-on edge)	112908	146	\$1,398
84" side cutter mounting tooth bar assembly (standard)	110742	129	\$1,267
84" over the edge side cutter mounting tooth bar (over bolt-on edge)	110748	147	\$1,858
84" side cutter mounting tooth bar assembly (standard)Σ	121769	151	\$1,204
<b>Spill Guard for High Capacity Buckets</b>			
63" spill guard assembly (use with 121748)	122040	23	\$254
68" spill guard assembly (use with 121753)	122041	25	\$260
75" spill guard assembly (use with 121680)	122042	28	\$310
80" spill guard assembly (use with 121654)	122035	30	\$271
84" spill guard assembly (use with 121674)	122043	31	\$275

\*use with 121596, 121592, 121748

\*\*use with 121599, 121603, 121753

¥ use with 121756, 121742, 121680

€ use with 121606, 121737, 121654

Σ use with 121759, 121745, 121674

Add Surcharge to all products 8.85%

# BUCKETS

## 4-IN-1 MULTI-PURPOSE STANDARD DUTY BUCKETS



- Ideal for site clean up, grading, scraping, grappling, dozing and brush removal
- Single bevel bolt on dozer edge, double bevel bolt on clam edges, front and back - these features are exclusive to FFC
- Many sizes available

Carrier Specifications	
Lift Capacity	Operating Weight
<9,000 lbs.	<11,000 lbs.



**IMPORTANT:** Prime Movers with tracks and with an operating weight of 7,000 lbs. or more **MUST** have port reliefs installed on the prime mover's main control valve to protect both sides of the auxiliary circuit.

Specifications								
Model #	Weight (Approx)	Degree Back	Width OD	Height	Depth	Clamshell Opening	Capacity Struck	Capacity Heaped
LAF0976	1390 lbs	75°	73"	21.5"	32"	29.4"	0.51 yd <sup>3</sup>	0.66 yd <sup>3</sup>
LAF0977	1475 lbs	75°	78"	21.5"	32"	29.4"	0.52 yd <sup>3</sup>	0.71 yd <sup>3</sup>
LAF0985	1540 lbs	75°	82"	21.5"	32"	29.4"	0.55 yd <sup>3</sup>	0.75 yd <sup>3</sup>
LAF0988	1343 lbs	75°	84"	21.5"	32"	29.4"	0.63 yd <sup>3</sup>	0.90 yd <sup>3</sup>
LAF0990	1400 lbs	75°	87"	21.5"	32"	29.4"	0.59 yd <sup>3</sup>	0.80 yd <sup>3</sup>
LAF0992	1434 lbs	75°	90"	21.5"	32"	29.4"	0.67 yd <sup>3</sup>	0.97 yd <sup>3</sup>

## 4-IN-1 MULTI-PURPOSE STANDARD DUTY BUCKETS FOR SKID-STEER LOADERS





**INCLUDES: BUCKET, MOUNT, HOSES AND COUPLERS FOR SKID-STEERS ONLY. TO COMPLETE A BUCKET ASSEMBLY: CHOOSE A BUCKET AND MOUNTING**

BUCKET			
CHECK LOADER CAPACITY BEFORE ORDERING			
	ORDER CODE	SHIP WEIGHT (LBS)	LIST PRICE
<b>(75 degree back)</b>			
73" OD Construction 4-in-1	LAF0976-0022	1390	\$7,455
78" OD Construction 4-in-1	LAF0977-0022	1475	\$7,925
82" OD Construction 4-in-1	LAF0985-0022	1540	\$8,270
<b>(Designed for Track Machines)</b>			
84" OD Construction 4-in-1 (70° back)	LAF0988-0022	1343	\$8,422
90" OD Construction 4-in-1 (70° back)	LAF0992-0022	1434	\$9,059

LIST PRICE of loader mounting must be added to the attachment LIST PRICE

MOUNTING	
ADDITIONAL COST MAY APPLY	
ORDER CODE	SHIP WEIGHT (LBS)
Contact Customer Service at (833) 723-1843	

## 4-IN-1 MULTI-PURPOSE STANDARD DUTY BUCKETS CONT.

### 4-IN-1 MULTI-PURPOSE STANDARD DUTY BUCKETS FOR SKID-STEER LOADERS CONT.

OPTIONS EXCLUSIVE TO FFC BUCKETS	ORDER CODE	SHIP WEIGHT (LBS)	LIST PRICE
<b>Extra Heavy-Duty Toothbar for Buckets with Bolt-On Edge</b>			
For Bucket LAF0976 with 8 teeth	LAF9173-FF41		POR
For Bucket LAF0977 with 9 teeth	LAF9179-FF41		\$2,219
For Bucket LAF0985 with 9 teeth	LAF9183-FF41		POR
For Bucket LAF0990 with 9 teeth	LAF9188-FF41		POR
For Bucket LAF0988	10640		\$2,590
For Bucket LAF0992	10641		\$3,022

## 4-IN-1 MULTI-PURPOSE HEAVY-DUTY BUCKETS



- Ideal for site clean up, grading, scraping, grappling, dozing and brush removal
- Single bevel bolt on dozer edge, double bevel bolt on clam edges, front and back - these features are exclusive to FFC
- Many sizes available
- Double .25" plate steel clamshell reinforced with .75" x 6" cutting edge front, .50" x 6" back and .50" wearbars; Wear-resistant Pacal steel tapered cutting edge: .75" x 6"; Wear-resistant Pacal steel tapered dozer edge; End plates: .375" with mounting brackets.

Carrier Specifications	
Lift Capacity	Operating Weight
<10,000 lbs.	<20,000 lbs.



**IMPORTANT:** Prime Movers with tracks and with an operating weight of 7,000 lbs. or more **MUST** have port reliefs installed on the prime mover's main control valve to protect both sides of the auxiliary circuit.

Specifications							
Model #	Weight (Approx)	Width OD	Height	Depth	Clamshell Opening	Capacity Struck	Capacity Heaped
LAF3182	1220 lbs	82"	34.5"	24.8"	41"	0.81 yd <sup>3</sup>	0.99 yd <sup>3</sup>
LAF3190	1295 lbs	90"	34.5"	24.8"	41"	0.89 yd <sup>3</sup>	1.10 yd <sup>3</sup>
LAF3196	1470 lbs	96"	34.5"	24.8"	41"	0.95 yd <sup>3</sup>	1.18 yd <sup>3</sup>

# BUCKETS

## 4-IN-1 MULTI-PURPOSE HEAVY-DUTY BUCKETS FOR BACKHOE LOADERS



**INCLUDES: BUCKET, MOUNT, HOSES AND COUPLERS FOR SKID-STEERS ONLY. TO COMPLETE A BUCKET ASSEMBLY: CHOOSE A BUCKET AND MOUNTING**

BUCKET			
CHECK LOADER CAPACITY BEFORE ORDERING			
	ORDER CODE	SHIP WEIGHT (LBS)	LIST PRICE
82" OD Construction 4-in-1 Heavy-Duty	LAF3182-0733	1220	\$9,129
90" OD Construction 4-in-1 Heavy-Duty	LAF3190-0733	1295	\$9,227
96" OD Construction 4-in-1 Heavy-Duty	LAF3196-0733	1470	\$10,055

MOUNTING	
ADDITIONAL COST MAY APPLY	
ORDER CODE	SHIP WEIGHT (LBS)
Contact Customer Service at (833) 723-1843	

OPTIONS - REVERSIBLE CUTTING EDGE KIT			
INCLUDES BOE, GRADE 8 PLOW BOLTS, LOCK WASHERS & NUTS FOR FRONT EDGE ONLY			
	ORDER CODE	SHIP WEIGHT (LBS)	LIST PRICE
For Bucket LAF3182 (9 holes, 9.75" spacing)*	15029	136	\$730
For Bucket LAF3190 (10 holes, 9" spacing)*	113991	150	\$771
For Bucket LAF3196 (9 holes, 10.82" spacing)*	11002	160	\$800

For Optional Bolt-On Edge Drill Patterns (i.e. Case Hole Patterns) - Call (833) 723-1843

Add Surcharge to all products 8.5%

## 4-IN-1 MULTI-PURPOSE BUCKETS



Functions as a loader bucket, clam, dozer, scraper, and bottom dump bucket

Strong hinges & pins to distribute load

Replacement bolt-on wear edge, bolt-on tooth bars, and bolt-on tooth bars that fit over weld-on wear edge

Options: Bolt-on side cutters, spill guards

Carrier Specifications	
Lift Capacity	Operating Weight
<9,000 lbs.	<11,000 lbs.



**IMPORTANT: Prime Movers with tracks and with an operating weight of 7,000 lbs. or more MUST have port reliefs installed on the prime mover's main control valve to protect both sides of the auxiliary circuit.**

Specifications					
Width	Weight (Approx)	Height	Grapple Depth	Heaped Opening	Capacity
<b>Utility</b>					
60"	585 lbs	27.32"	34.5"	35"	14.25 cu/ft
66"	620 lbs	27.32"	34.5"	35"	15.75 cu/ft
72"	655 lbs	27.32"	34.5"	35"	17.25 cu/ft
<b>Construction</b>					
72"	900 lbs	27.69"	37.47"	34.79"	19.99 cu/ft
78"	935 lbs	27.69"	37.47"	34.79"	21.69 cu/ft
84"	975 lbs	27.69"	37.47"	34.79"	23.4 cu/ft
<b>Euro Global ISO23206</b>					
72"	940 lbs	27.69"	37.47"	34.79"	19.99 cu/ft
78"	975 lbs	27.69"	37.47"	34.79"	21.69 cu/ft
84"	1015 lbs	27.69"	37.47"	34.79"	23.4 cu/ft

## 4-IN-1 MULTI-PURPOSE BUCKETS FOR SKID-STEER LOADERS





**INCLUDES: BUCKET AND UNIVERSAL SSL MOUNT.**  
**TO COMPLETE A BUCKET ASSEMBLY: CHOOSE A BUCKET AND MOUNTING**

BUCKETS			
4-IN-1 CONSTRUCTION & UTILITY	ORDER CODE	SHIP WEIGHT (LBS)	LIST PRICE
<b>Utility Buckets 4-in-1 Bucket With &amp; Without Teeth Universal Mount</b>			
60" utility bucket no hoses	111470	585	\$4,500
66" utility bucket no hoses	108018	620	\$4,357
66" utility bucket with teeth, no hoses	108019	675	\$4,844
72" utility bucket no hoses	108020	655	\$4,688
72" utility bucket with teeth, no hoses	108021	713	\$5,107
<b>Construction Buckets 4-in-1 Bucket With &amp; Without Teeth Universal Mount</b>			
72" construction bucket no hoses	108022	900	\$5,298
72" construction bucket with teeth, no hoses	108023	958	\$5,404
78" construction bucket no hoses	108024	935	\$5,459
78" construction bucket with teeth, no hoses	108025	993	\$5,814
84" construction bucket no hoses	108026	975	\$5,654
84" construction bucket with teeth, no hoses	108027	1040	\$5,991

# BUCKETS

## 4-IN-1 MULTI-PURPOSE BUCKETS CONT.

### 4-IN-1 MULTI-PURPOSE BUCKETS FOR SKID-STEER LOADERS CONT.



BUCKETS

BUCKETS			
4-IN-1 CONSTRUCTION & UTILITY			
	ORDER CODE	SHIP WEIGHT (LBS)	LIST PRICE

Construction Euro Global ISO 23206 Mount 4-in-1 Buckets			
72" construction bucket no hoses	111190	940	\$5,501
78" construction bucket no hoses	111777	975	\$6,209
84" construction bucket no hoses	111778	1015	\$6,623

HYDRAULIC KITS (SOLD SEPARATELY)			
	ORDER CODE	SHIP WEIGHT (LBS)	LIST PRICE

66" long hose kit with flat face couplers	103577	10	\$365
75" long hose kit with flat face couplers	105845	13	\$441
94" long hose kit with flat face couplers	103603	10	\$305

OPTIONS			
UTILITY BUCKET OPTIONS			
	ORDER CODE	SHIP WEIGHT (LBS)	LIST PRICE

Spill Guard Assembly			
60" spill guard for utility bucket	111676	26	\$362
66" spill guard for utility bucket	108875	28	\$312
72" spill guard for utility bucket	107530	30	\$272

Bolt-on Edge Assembly			
60" bolt-on edge assembly for utility bucket	15025	124	\$535
66" bolt-on edge assembly for utility bucket	15027	110	\$550
72" bolt-on edge assembly for utility bucket	15028	150	\$552

Tooth Bar Assembly			
66" tooth bar (standard)	33822	90	\$910
66" tooth bar (over bolt-on edge)	16987	116	\$1,514
72" tooth bar (standard)	33823	100	\$1,029
72" tooth bar (over bolt-on edge)	16988	130	\$998

CONSTRUCTION BUCKET OPTIONS			
	ORDER CODE	SHIP WEIGHT (LBS)	LIST PRICE

Spill Guard Assembly			
72" spill guard for construction bucket	107530	30	\$272
78" spill guard for construction bucket	108880	33	\$282
84" spill guard for construction bucket	108883	35	\$314

Bolt-on Edge Assembly			
72" bolt-on edge assembly	15028	150	\$552
78" bolt-on edge assembly	16204	130	\$700
84" bolt-on edge assembly	16183	240	\$715

Tooth Bar Assembly side cutter hole mounting (construction only)			
--	--	--	--

72" side cutter mounting tooth bar assembly (standard)	110738	100	\$1,060
72" over the edge side cutter mounting tooth bar (over bolt-on edge)	110744	130	\$1,603
78" side cutter mounting tooth bar assembly (standard)	110740	109	\$1,212
78" over the edge side cutter mounting tooth bar (over bolt-on edge)	110746	132	\$1,476
84" side cutter mounting tooth bar assembly (standard)	110742	129	\$1,267
84" over the edge side cutter mounting tooth bar(over bolt-on edge)	110748	147	\$1,858
side cutter assembly (construction ONLY)	107786	18	\$148



## 4-IN-1 MULTI-PURPOSE BUCKETS CONT.

### 4-IN-1 MULTI-PURPOSE BUCKETS FOR COMPACT TRACTORS

COMPACT TRACTORS	ORDER CODE	SHIP WEIGHT (LBS)	LIST PRICE
60" 4-in-1 bucket with universal hitch	108196	380	\$3,780
72" 4-in-1 bucket	108198	430	\$4,098

### 4-IN-1 MULTI-PURPOSE BUCKETS FOR TRACTOR LOADERS/BACKHOES



TRACTOR LOADER / BACKHOE MOUNTS	ORDER CODE	SHIP WEIGHT (LBS)	LIST PRICE
<b>1.25 YD</b>			
Cat IT/TH edge group A	11069	1920	\$9,260
Cat IT/TH 90" wide	11582	1920	\$9,750
JCB Q-fit edge group B	11066	1920	\$8,101
John Deere 310D/410D pin mount edge group B	12612	1570	\$7,800
Komatsu WB140 edge group B	12478	1600	\$7,800
<b>1.50 YD</b>			
JCB 214 Q-fit 96" wide with edge	12891	1820	\$8,370
New Holland LB 90/110 pin mount edge group B	12520	1765	\$9,118
New Holland LB115 pin mount edge group B	312861	1765	\$9,118
Komatsu WB 1401150 TLB edge group B	12908	1700	\$8,370

### 4-IN-1 MULTI-PURPOSE BUCKETS FOR WHEEL LOADERS



WHEEL LOADERS	ORDER CODE	SHIP WEIGHT (LBS)	LIST PRICE
<b>1.00 YD</b>			
Komatsu WA75-3	108660	1550	\$8,560
Wacker WL50 80" wide with edge	13236	1575	\$8,690
<b>1.25 YD</b>			
Cat IT/TH edge group A	11069	1920	\$9,260
JCB 411HT edge group B	11061	1570	\$11,061
JCB 411 Pin-on with edge	12823	1920	\$11,451
<b>1.50 YD</b>			
JCB 409B 84" wide (serial #130-2000 and higher) edge group 18057	13229	1750	\$11,850
<b>2.00 YD</b>			
JCB 416 HT with edge	12774	2500	\$8,676
JCB 416 edge group 313851	13307	2500	\$11,950
<b>2.25 YD</b>			
blank no mounts 106" wide includes bolt-on edge kit	101769	2550	\$15,250
CAT IT 96" wide with edge	12374	3000	\$16,215
<b>2.50 YD</b>			
Cat IT14/IT24/IT28 106" wide with edge	12320	3200	\$17,950

# BUCKETS

## BUCKET ACCESSORIES AND ADD-ONS

### BUCKET ACCESSORIES AND ADD-ONS FOR SKID-STEER LOADERS



**FINISH WELDING OF MOUNTINGS MAY BE REQUIRED AFTER MOUNTING IS WELDED TO THE ATTACHMENTS. ADDITIONAL GUSSETS MAY BE REQUIRED WHEN WELDING TO CERTAIN ATTACHMENTS.**

WELD-ON BUCKET EDGE & END PIECES	ORDER CODE	SHIP WEIGHT (LBS)	LIST PRICE
.375" x 3" Single Bevel Weld-On Edge	RSB0383	0.3	\$4
.50" x 4" Single Bevel Weld-On Edge	RSB0504	0.6	\$4
.75" x 6" Single Bevel Weld-On Edge	RSB0756	14	\$9
1.0" x 8" Single Bevel Weld-On Edge	RSB1008	2	\$9
.50" x 4" End Piece for Bucket - Left Hand	LAF9756-0000	3	\$26
.50" x 4" End Piece for Bucket - Right Hand	LAF9757-0000	3	\$26
.75" x 6" End Piece for Bucket - Left Hand	LAF9937-0000	6	\$44
.75" x 6" End Piece for Bucket - Right Hand	LAF9938-0000	6	\$44

REVERSIBLE CUTTING EDGE *DRILLED FOR FFC BOLT-ON EDGE (HOLES SPACED 6" APART, CENTER TO CENTER)	ORDER CODE	SHIP WEIGHT (LBS)	LIST PRICE
.75" x 8" reversible edge with 13/16" holes spaced 6" apart	RDB0758	19	\$10
.75" x 2.5" Grade 8 plow bolts with lock washers and nut	LAF9737-0000	NA	\$13

## FORK POCKET BUCKET



### FORK POCKET BUCKETS FOR TRACTOR LOADERS/BACKHOES AND WHEEL LOADERS

FORK POCKET BUCKET	ORDER CODE	SHIP WEIGHT (LBS)	LIST PRICE
fork pocket bucket 96" 1.5 yd	11082	1000	\$5,686

## HEAVY-DUTY CONSTRUCTION/INDUSTRIAL BUCKETS

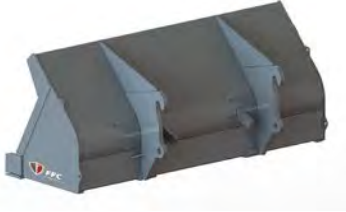
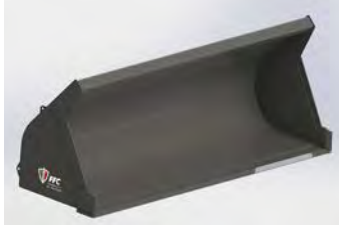

- Designed for leveling, digging and loading dirt, rock and other abrasive material
- Constructed with stronger material and heavy-duty wear edges or optional teeth for penetration
- 83" and 98" models for general purpose work
- .75" x 6" wear-resistant Pacal steel tapered cutting edge
- Reversible cutting edge available

Carrier Specifications	
Lift Capacity	Operating Weight
<10,000 lbs.	<32,000 lbs.

Specifications							
Model	Weight (approx)	Width OD	Height A	Depth B	Leading Edge C	Capacity Struck	Capacity Heaped
LAF3382	830 lbs	83"	32.2"	26.8"	26.8"	0.93 yd <sup>3</sup>	1.11 yd <sup>3</sup>
LAF 3390	863 lbs	92"	32.2"	26.8"	26.8"	1.03 yd <sup>3</sup>	1.23 yd <sup>3</sup>
LAF3396	939 lbs	98"	35.6"	30.0"	9.6"	1.27 yd <sup>3</sup>	1.52 yd <sup>3</sup>
LAF3397	1009 lbs	98"	38.6"	35.8"	12.4"	1.65 yd <sup>3</sup>	1.99 yd <sup>3</sup>

## HEAVY-DUTY CONSTRUCTION/INDUSTRIAL BUCKETS FOR TRACTOR LOADERS/BACKHOES



**INCLUDES: BUCKET AND UNIVERSAL SSL MOUNTING TO COMPLETE A BUCKET ASSEMBLY: CHOOSE A BUCKET AND MOUNTING**

BUCKET			
CHECK LOADER CAPACITY BEFORE ORDERING			
	ORDER CODE	SHIP WEIGHT (LBS)	LIST PRICE
83" OD Construction/Industrial Bucket	LAF3382	830	\$4,392
92" OD Construction/Industrial Bucket	LAF3390	863	\$4,494
98" OD Construction/Industrial Bucket	LAF3396	939	\$4,525
98" OD Extra Capacity Construction/Industrial Bucket	LAF3397	1009	\$4,675

OPTIONAL - REVERSIBLE CUTTING EDGE KIT			
INCLUDES BOE, GRADE 8 PLOW BOLTS, LOCK WASHERS & NUTS			
	ORDER CODE	SHIP WEIGHT (LBS)	LIST PRICE
For Bucket LAF3382 (9 holes, 9.75" spacing)*	15029	133	\$730
For Bucket LAF3390 (9 holes, 10.82" spacing)*	309996	143	\$657
For Bucket LAF3396 (9 holes, 10.82" spacing)*	114197	155	\$881
For Bucket LAF3397 (9 holes, 10.82" spacing)*	114197	155	\$881

For Optional Bolt-On Edge Drill Patterns (i.e. Case Hole Patterns) - Call (833) 723-1843

OPTIONS - TOOTHBAR			
EXCLUSIVE TO FFC BUCKETS			
	ORDER CODE	SHIP WEIGHT (LBS)	
<b>Heavy-Duty Toothbar for Buckets without Bolt-On Edge</b>			
For Bucket LAF3382 with 10 teeth	10565	150	\$1,406
For Bucket LAF3390 with 10 teeth	10585	157	\$1,511
<b>Heavy-Duty Toothbar for Buckets with Bolt-On Edge</b>			
For Bucket LAF3396 and LAF3397 with 10 teeth	10604	196	\$2,005

# BUCKETS

## HEAVY-DUTY CONSTRUCTION/INDUSTRIAL BUCKETS CONT.

### HEAVY-DUTY CONSTRUCTION/INDUSTRIAL BUCKETS FOR WHEEL LOADERS



**INCLUDES: BUCKET AND UNIVERSAL SSL MOUNTING  
TO COMPLETE A BUCKET ASSEMBLY: CHOOSE A BUCKET AND MOUNTING**

BUCKET CHECK LOADER CAPACITY BEFORE ORDERING	ORDER CODE	SHIP WEIGHT (LBS)	LIST PRICE
83" OD Construction/Industrial Bucket	LAF3382-0733	830	\$3,625
92" OD Construction/Industrial Bucket	LAF3390-0733	863	\$3,595
98" OD Construction/Industrial Bucket	LAF3396-0733	939	\$3,895
98" OD Extra Capacity Construction/Industrial Bucket	LAF3397-0733	1009	\$3,899

OPTIONS - TOOTHBAR EXCLUSIVE TO FFC BUCKETS	ORDER CODE	SHIP WEIGHT (LBS)	LIST PRICE
<b>Heavy-Duty Toothbar for Buckets with Bolt-On Edge</b>			
For Bucket LAF3396 and LAF3397 with 10 teeth	10604	196	\$2,005

Add Surcharge to all products 8.85%

## HEAVY-DUTY GENERAL PURPOSE BUCKETS



### HEAVY-DUTY GENERAL PURPOSE BUCKETS FOR TRACTOR LOADERS/BACKHOES



**INCLUDES: BUCKET AND MOUNT UNLESS NOTED BUCKETS ARE 96" WIDE**

TRACTOR LOADER / BACKHOE MOUNT		ORDER CODE	SHIP WEIGHT (LBS)	LIST PRICE
<b>1.0 YD BUCKET</b>				
Cat IT/TH 80" wide	edge group F	12649	961	\$3,984
Cat IT/TH 72" wide	edge kit 309610	12671	900	\$5,399
Ford 545 pin-on		11082	1000	\$5,686
JCB Q-fit 85" wide		12809	1000	\$5,650
<b>1.25 YD BUCKET</b>				
JCB Q-fit	edge group B	12329	1050	\$5,780
<b>1.50 YD BUCKET</b>				
Cat IT/TH 96" wide	edge group A	11080	1250	\$4,367
Cat IT/TH 84" wide	edge group D	11092	1250	\$5,055
<b>1.75 YD BUCKET</b>				
Case 680L pin on	edge group B	12422	1290	\$5,600
Cat IT/TH	edge group A	11107	1110	\$5,113
JCB 210 / 212S 90" wide	edge group 317900	12642	950	\$12,642
JCB Q-fit	edge group B	12770	1290	\$5,113
New Holland LB115 direct mount	edge group B	12334	1290	\$5,113
<b>2.00 YD BUCKET</b>				
JCB 214 pin mount 85" wide		11559	1290	\$5,980
<b>2.25 YD BUCKET</b>				
Cat IT/TH	edge group A	11182	1491	\$6,889
JCB 214-217 pin mount 1.66 yd struck	edge kit B	11186	1491	\$6,889
<b>2.50 YD BUCKET</b>				
Case 570-580L/super M (Pin-On Mount)	edge group B	12902	1550	\$6,950
Cat IT/TH	edge group A	11210	1425	\$6,875
JCB 214-217S pin mount 96" wide	edge group A	12796	1410	\$6,889

TRACTOR LOADER / BACKHOE MOUNTS CONTINUED NEXT PAGE

# BUCKETS

## HEAVY-DUTY GENERAL PURPOSE BUCKETS CONT.

### HEAVY-DUTY GENERAL PURPOSE BUCKETS FOR TRACTOR LOADERS/BACKHOES CONT.

OPTIONS - BUCKET CUTTING EDGES	ORDER CODE	SHIP WEIGHT (LBS)	LIST PRICE	
<b>TRACTOR LOADER/BACKHOE</b>				
Group A - .75" x 10" x 96", CAT 9U9665 style, 2 pc. edge group with hardware	12 holes	14611	225	POR
Group B - .75" x 8" x 96" overall with hardware	9 holes	11002	160	POR
Group C - .75" x 6" x 90.63" overall with hardware	8 holes	12297	135	\$541
Group D - .75" x 8" x 84" overall with hardware	9 holes	18057	170	\$827
Group E - .75" x 8" x 82" overall with hardware	7 holes	17718	160	\$680
Group F - .75" x 8" x 79.5" overall with hardware	7 holes	309995	155	\$447
Group G - .75" x 8" x 92.5" overall with hardware	9 holes	309996	155	POR
Group H - .75" x 8" x 102" overall JBC 3 piece edge with hardware	9 holes	12676	195	\$174
<b>EDGE GROUPS</b>				
Edge Group (6 holes total) - .75" x 8" x 66"		18682	130	\$762
Edge Group (7 holes total)- .75" x 8" x 61"		15025	124	POR
Edge Group (7 holes total) - .75" x 8" x 73"		15028	150	\$552
Edge Group (7 holes total) - .75" x 8" x 74"		100831	150	\$482
Edge Group (7 holes total)- .75" x 8" x 77"		14989	155	\$602
Edge Group (7 holes total) - .75" x 8" x 78"		12597	165	\$851
Edge Group (8 holes total) - .75" x 8" x 85"		12812	170	\$637
Edge Group (9 holes total) - .75" x 8" x 90"		12286	180	\$754
Edge Group (15 holes total) - 1.0" x 10" x 106"		32950	250	\$1,886

### HEAVY-DUTY GENERAL PURPOSE BUCKETS FOR WHEEL LOADERS



WHEEL LOADERS	ORDER CODE	SHIP WEIGHT (LBS)	LIST PRICE
<b>.50 YD BUCKET</b>			
Cat 902/906/908 46" wide with edge	12747	600	\$2,786
Cat 902/906/906 66" wide edge 18682 not included	12683	709	\$5,750
JCB 407B 54" wide includes edge	11015	583	\$4,454
Komatsu WA75/85/95 66" wide edge kit 18682 optional	12546	60	\$5,750
<b>.75 YD BUCKET</b>			
Volvo L30 77" wide edge kit 14989	12804	568	\$3,432

WHEEL LOADERS CONTINUED NEXT PAGE

## HEAVY-DUTY GENERAL PURPOSE BUCKETS CONT.

### HEAVY-DUTY GENERAL PURPOSE BUCKETS FOR WHEEL LOADERS CONT.

WHEEL LOADERS		ORDER CODE	SHIP WEIGHT (LBS)	LIST PRICE
<b>1.0 YD BUCKET</b>				
Case 221E 60" wide with edge		13261	970	\$3,892
Cat IT/TH 72" wide	edge group 15028	13221	824	\$4,467
Cat IT/TH 72" wide with edge		12671	900	\$5,399
Cat IT/TH 80" wide with edge	edge group F	12649	961	\$3,984
Furukawa w/universal hitch 72" wide	edge group 12504	11058	500	\$4,467
JCB 407/409BZX 77" wide	edge kit 14989	12388	850	\$3,213
JCB 407/409BZX 85" wide 1.00 yd		11051	900	\$4,250
JCB 407/409BZX 96" wide 1.12 yd		12315	900	\$4,970
JCB 409B 77" wide (serial # 130-22009 and higher)	edge kit 14989	13162	770	\$3,145
JCB 411-72" wide with edge	edge kit 309610	12671	900	POR
JCB 416HT 72" wide mulch bkt with edge	edge group 309610	12663	900	\$4,467
New Holland LW 80 with QA 60" wide		12785	940	\$658
New Holland LW-80 with QA 72" wide		12424	960	\$4,467
TCM 820 76.8" wide		15207	800	\$3,544
Volvo L30-L35 60" wide with edge		12787	970	\$4,741
Volvo L40 60" wide with edge		13054	650	\$4,866
Volvo L40-120 77" wide	edge kit 14989	13248	769	\$4,685
<b>1.25 YD BUCKET</b>				
Atlas 70" wide		12282	900	\$4,250
TCM E806 66.5" wide		15206	800	\$4,465
<b>1.50 YD BUCKET</b>				
Cat IT/TH 96" wide	edge group A	11080	1250	POR
Cat IT/TH 84" wide	edge group D	11092	1250	POR
JCB 407/409BZX 85" wide		12372	1250	\$242
JCB 407/409BZX 77" wide with edge		12658	1044	\$2,022
<b>1.75 YD BUCKET</b>				
Cat IT/TH		11107	1110	POR
JCB 409B 84" wide (serial # 130-2000 and higher)	edge group 14989	13238	973	\$4,685
Wacker 750T/418/850	edge group 18057	13249	1210	\$5,125
JCB 409BZX with edge		12645	1070	\$4,595
<b>2.0 YD BUCKET</b>				
Cat 902 / 906 / 908 with skid-steer mount	edge group A	12573	1320	\$5,350
Case 221D / 321D 78"	edge group 12597	12942	1225	\$4,685
JCB 407/408/409A 78"	edge group 12597	12717	1320	\$7,119
New Holland LW-70 / LW-80 78"	edge group 12597	12942	1225	POR

WHEEL LOADERS CONTINUED NEXT PAGE

# BUCKETS

BUCKETS

## HEAVY-DUTY GENERAL PURPOSE BUCKETS CONT.

### HEAVY-DUTY GENERAL PURPOSE BUCKETS FOR WHEEL LOADERS CONT.

WHEEL LOADERS CONT.		ORDER CODE	SHIP WEIGHT (LBS)	LIST PRICE
<b>2.25 YD BUCKET</b>				
Cat IT/TH	edge group A	11182	1491	POR
<b>2.50 YD BUCKET</b>				
Cat IT/TH	edge group A	11210	1425	POR
<b>2.60 YD BUCKET</b>				
Cat IT/TH 42" ext spill guard	edge group A	12258	1663	\$7,005
<b>2.75 YD BUCKET</b>				
Cat IT/TH	edge group A	306197	1670	\$8,132
<b>3.00 YD BUCKET</b>				
Cat IT/TH	edge group A	12271	1700	\$7,159
Volvo L40-L45	edge group B	13166	1650	\$7,159
<b>3.25 YD BUCKET</b>				
Cat IT/TH	edge group A	15202	1210	\$8,216
<b>4.00 YD BUCKET</b>				
Cat IT/TH	edge group A	11276	1800	\$10,270
Cat IT/TH light material high visibility	edge group A	12423	1783	\$9,577
JCB Q-fit light material high visibility	edge group B	12708	1727	\$10,270

OPTIONS - BUCKET CUTTING EDGES*		ORDER CODE	SHIP WEIGHT (LBS)	LIST PRICE
<b>WHEEL LOADER MOUNTS</b>				
Group A - .75" x 10" x 96", CAT 9U9665 style, 2 pc. edge group with hardware	12 holes	14611	225	POR
Group B - .75" x 8" x 96" overall with hardware	9 holes	11002	160	POR
Group C - .75" x 6" x 90.63" overall with hardware	8 holes	12297	135	\$541
Group D - .75" x 8" x 84" overall with hardware	9 holes	18057	170	\$827
Group E - .75" x 8" x 82" overall with hardware	7 holes	17718	160	POR
Group F - .75" x 8" x 79.5" overall with hardware	7 holes	309995	155	POR
Group G - .75" x 8" x 92.5" overall with hardware	9 holes	309996	155	POR
Group H - .75" x 8" x 102" overall JBC 3 piece edge with hardware	9 holes	12676	195	POR
<b>EDGE GROUPS</b>				
Edge Group (6 holes total) - .75" x 8" x 66"		18682	130	\$762
Edge Group (7 holes total) - .75" x 8" x 61"		15025	124	POR
Edge Group (7 holes total) - .75" x 8" x 73"		15028	150	\$552
Edge Group (7 holes total) - .75" x 8" x 74"		100831	150	\$482
Edge Group (7 holes total) - .75" x 8" x 77"		14989	155	POR
Edge Group (7 holes total) - .75" x 8" x 78"		12597	165	POR
Edge Group (8 holes total) - .75" x 8" x 85"		12812	170	POR
Edge Group (9 holes total) - .75" x 8" x 90"		12286	180	POR
Edge Group (15 holes total) - 1.0" x 10" x 106"		32950	250	\$1,886

## HEAVY-DUTY MATERIAL BUCKET



- Three sizes fit wide range of applications
- Wear-resistant Pacal steel tapered cutting edge



**IMPORTANT:** FFC Skid-Steer buckets have a 70° angle on the back. This may increase or decrease the effective rollback and dump angles of your Skid-Steer. Specify Skid-Steer make and model when ordering.

Carrier Specifications	
Lift Capacity	Operating Weight
<5,000 lbs.	<8,000 lbs.

Specifications							
Model	Weight (approx)	Width OD	Height	Depth	Leading Edge	Capacity	Capacity Heaped
LAF0464	626 lbs	65"	29"	38"	28"	0.78 yd <sup>3</sup>	1.00 yd <sup>3</sup>
LAF0473	693 lbs	72"	29"	38"	28"	0.87 yd <sup>3</sup>	1.13 yd <sup>3</sup>
LAF0481	760 lbs	82"	29"	38"	28"	0.97 yd <sup>3</sup>	1.26 yd <sup>3</sup>

## HEAVY-DUTY MATERIAL BUCKETS FOR SKID-STEER LOADERS



**INCLUDES: BUCKET AND UNIVERSAL SSL MOUNTING TO ORDER: CHOOSE BUCKET AND MOUNT**

BUCKET	ORDER CODE	SHIP WEIGHT (LBS)	LIST PRICE
<b>CHECK LOADER CAPACITY BEFORE ORDERING</b>			
65" OD Heavy-Duty Material Bucket	LAF0464-0022	756	\$2,471
72" OD Heavy-Duty Material Bucket	LAF0473-0022	693	\$2,537
82" OD Heavy-Duty Material Bucket	LAF0481-0022	760	\$2,603

LIST PRICE of loader mounting must be added to the attachment LIST PRICE

MOUNTING	ORDER CODE	SHIP WEIGHT (LBS)	LIST PRICE
<b>ADDITIONAL COST MAY APPLY</b>			
Contact Customer Service at (833) 723-1843			

OPTIONS	ORDER CODE	SHIP WEIGHT (LBS)	LIST PRICE
<b>REVERSIBLE CUTTING EDGE KIT</b>			
<b>INCLUDES BOE, GRADE 8 PLOW BOLTS, LOCK WASHERS &amp; NUTS</b>			
<b>Drilled for FFC Bolt-On Edge (Holes spaced 6" apart, center to center)</b>			
For Bucket LAF0464* 7 holes, 10" spacing	15027	120	\$550
For Bucket LAF0473* 7 holes, 11" spacing	102236	123	\$718
For Bucket LAF0481* 9 holes, 9.75" spacing	15029	136	\$730

**For Optional Bolt-On Edge Drill Patterns (i.e. Case Hole Patterns) - Call (833) 723-1843**

# BUCKETS

BUCKETS

## HEAVY-DUTY MATERIAL BUCKET CONT.

### HEAVY-DUTY MATERIAL BUCKETS FOR SKID-STEER LOADERS CONT.

TOOTHBAR - EXCLUSIVE TO FFC BUCKETS	ORDER CODE	SHIP WEIGHT (LBS)	LIST PRICE
<b>Standard-Duty Toothbar for Buckets with Bolt-On Edge</b>			
For Bucket LAF0481 with 8 teeth	10558	97	\$889
<b>Heavy-Duty Toothbar for Buckets without Bolt-On Edge</b>			
For Bucket LAF0473 with 8 teeth	10539	126	\$935
For Bucket LAF0481 with 9 teeth	10559	141	\$1,433
<b>Heavy-Duty Toothbar for Buckets with Bolt-On Edge</b>			
For Bucket LAF0473 with 8 teeth	10540	154	\$1,053

FOR CUSTOM TOOTHBARS OR TOOTHBARS WITHOUT FFC BOLT-ON EDGE - CALL (833) 723-1843

Add Surcharge to all products 8.85%

## HEAVY-DUTY AG LOADER TRACTOR BUCKET



- Four sizes fit wide range of loaders
- 10 gauge, reinforced wrapper
- 8" bolt-on spill guard available
- Bolt-on reversible cutting edges and tooth bars available

Carrier Specifications	
Lift Capacity	Operating Weight
<10,000 lbs.	<32,000 lbs.

Specifications							
Model	Weight (approx)	Width OD	Height	Depth	Leading Edge	Capacity Struck	Capacity Heaped
LAF2560	502 lbs	62"	24"	33"	20.75"	0.61 yd <sup>3</sup>	0.74 yd <sup>3</sup>
LAF2572	569 lbs	74"	24"	33"	20.75"	0.73 yd <sup>3</sup>	0.90 yd <sup>3</sup>
LAF2584	661 lbs	86"	24"	33"	20.75"	0.85 yd <sup>3</sup>	1.06 yd <sup>3</sup>
LAF2596	744 lbs	98"	24"	33"	20.75"	0.97 yd <sup>3</sup>	1.21 yd <sup>3</sup>

## HEAVY-DUTY BUCKETS FOR AG LOADER TRACTOR



**INCLUDES: BUCKET ONLY**  
**LIST PRICE OF LOADER MOUNTING MUST BE ADDED TO THE ATTACHMENT LIST PRICE.**

BUCKET	ORDER CODE	SHIP WEIGHT (LBS)	LIST PRICE
--------	------------	-------------------	------------

**CHECK LOADER CAPACITY BEFORE ORDERING**

62" OD HD Round Utility Bucket	LAF2560-0022	502	\$2,172
74" OD HD Round Utility Bucket	LAF2572-0022	569	\$2,492
86" OD HD Round Utility Bucket	LAF2584-0022	661	\$2,758
98" OD HD Round Utility Bucket	LAF2596-0022	744	\$2,994

MOUNTING	ORDER CODE	SHIP WEIGHT (LBS)	LIST PRICE
----------	------------	-------------------	------------

**ADDITIONAL COST MAY APPLY**

Contact Customer Service at (833) 723-1843

OPTIONS	ORDER CODE	SHIP WEIGHT (LBS)	LIST PRICE
---------	------------	-------------------	------------

**REVERSIBLE CUTTING EDGE KIT - INCLUDES BOE, GRADE 8 PLOW BOLTS, LOCK WASHERS & NUTS**

For Bucket LAF2560 (7 holes, 9" spacing)*	114011	103	\$609
For Bucket LAF2572 (7 holes, 11" spacing)*	102236	123	\$718
For Bucket LAF2584 (9 holes, 10" spacing)*	113978	143	\$963
For Bucket LAF2596 (9 holes, 10.82" spacing)*	114197	163	POR

For Optional Bolt-On Edge Drill Patterns (i.e. Case Hole Patterns) - Call (833) 723-1843

HEAVY-DUTY UTILITY BUCKET OPTIONS CONTINUED NEXT PAGE

# BUCKETS

## HEAVY-DUTY AG LOADER TRACTOR BUCKET CONT. HEAVY-DUTY BUCKETS FOR AG LOADER TRACTORS CONT.

BUCKETS

OPTIONS CONT.			
BOLT-ON SPILL GUARD PREVENTS SPILLAGE WHEN CARRYING LARGE CAPACITY LOADS	ORDER CODE	SHIP WEIGHT (LBS)	LIST PRICE
8" Spill Guard for LAF2560	LAF2562-0000	40	\$302
8" Spill Guard for LAF2572	LAF2574-0000	40	\$332
8" Spill Guard for LAF2584	LAF2586-0000	40	\$405
8" Spill Guard for LAF2596	LAF2598-0000	40	\$393
TOOTHBAR - EXCLUSIVE TO FFC BUCKETS	ORDER CODE	SHIP WEIGHT (LBS)	LIST PRICE
<b>Standard-Duty Toothbar for Buckets without Bolt-On Edge</b>			
For Bucket LAF2560 with 7 teeth	10513	65	\$859
For Bucket LAF2584 with 10 teeth	10573	90	\$1,284
For Bucket LAF2596 with 10 teeth	10601	96	\$1,235
<b>Heavy-Duty Toothbar for Buckets without Bolt-On Edge</b>			
For Bucket LAF2572 with 8 teeth	10539	126	\$935
For Bucket LAF2584 with 10 teeth	10575	152	\$1,590
For Bucket LAF2596 with 10 teeth	10603	161	\$1,597
<b>Heavy-Duty Toothbar for Buckets with Bolt-On Edge</b>			
For Bucket LAF2572 with 8 teeth	10540	154	\$1,053
For Bucket LAF2584 with 8 teeth	10576	175	POR
For Bucket LAF2596 with 10 teeth	10604	196	POR

Add Surcharge to all products 8.85%

## HIGH-CAPACITY HEAVY-DUTY BUCKET

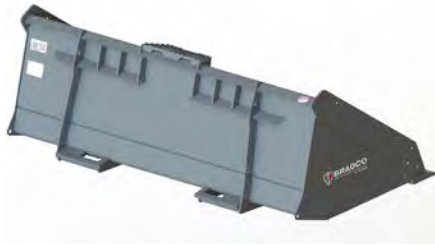

- 75", 80" & 84" with 1" cutting edge and back drag plating for strength wear protection
- Strong box sections across the top, heel, & front edge
- High tensile side plates
- Used for nursery applications, snow removal & construction

Specifications					
Width	Weight (approx)	Height	Depth	Rollback Angle	Capacity Heaped
75"	633 lbs	25"	38"	20°	21 ft <sup>3</sup>
75" *	633 lbs	25"	38"	20°	21 ft <sup>3</sup>
80"	746 lbs	25"	38"	20°	25 ft <sup>3</sup>
80" *	810 lbs	25"	38"	20°	25 ft <sup>3</sup>
84"	749 lbs	25"	38"	20°	27 ft <sup>3</sup>
84" *	813 lbs	25"	38"	20°	27 ft <sup>3</sup>

\*Bucket with 9 teeth

## HIGH-CAPACITY HEAVY-DUTY BUCKETS FOR SKID-STEER LOADERS



	ORDER CODE	SHIP WEIGHT (LBS)	LIST PRICE
63" high capacity dirt bucket with bolt on teeth	121748	490	\$2,171
68" high capacity dirt bucket with bolt on teeth	121753	522	\$2,112
75" high capacity dirt bucket (21.0 ft <sup>3</sup> ) 8 holes/10.01" spacing	125784	633	\$2,253
75" high capacity dirt bucket with 8 teeth	125785	690	\$2,453
75" high capacity dirt bucket with bolt on teeth	121680	602	\$1,792
80" high capacity dirt bucket (24.7 ft <sup>3</sup> ) 7 holes/12" spacing	125786	746	\$2,615
80" high capacity dirt bucket with 9 teeth	125787	810	\$2,815
80" high capacity dirt bucket with bolt on teeth	121654	646	\$3,524
84" high-capacity dirt bucket (26.8 ft <sup>3</sup> ) 9 holes/9.75" spacing	125788	749	\$3,075
84" high capacity dirt bucket with 9 teeth	125789	813	\$3,275
84" high capacity dirt bucket with bolt on teeth	121674	670	\$3,567

## "DIRT-READY" HIGH-CAPACITY HEAVY-DUTY BUCKETS FOR SKID-STEER LOADERS



"DIRT READY" BUCKETS INCLUDE SIDE CUTTERS AND EITHER BOE OR TEETH	ORDER CODE	SHIP WEIGHT (LBS)	LIST PRICE
75" high capacity dirt bucket w/boe & side cutters	KD107023	772	\$2,400
75" high capacity dirt bucket w/teeth and side cutters	KD107024	707	\$2,105
80" high capacity dirt bucket w/boe & side cutters	KD113428	900	\$2,654
80" high capacity dirt bucket w/teeth and side cutters	KD113429	842	\$2,608
84" high capacity dirt bucket w/teeth and side cutters	KD18453	940	\$3,275
84" high capacity dirt bucket w/boe & side cutters	KD18452	970	\$3,075
90" high capacity dirt bucket w/teeth & side cutters	239639	875	\$3,350
90" high capacity dirt bucket w/boe & side cutters	239640	900	\$3,550
96" high capacity dirt bucket w/teeth & side cutters	239663	925	\$3,450
96" high capacity dirt bucket w/boe & side cutters	239664	936	\$3,650

# BUCKETS

## HIGH-CAPACITY LIGHT MATERIAL BUCKET



- .75" x 6" high carbon, beveled edge
- Optional bolt-on wear edge
- Wear plating across bottom to prevent damage on bucket floor
- Forward swept top wrap to better contain wet or loose materials



Specifications				
Width	Weight (approx)	Height	Depth	Capacity Heaped
84"	740 lbs	35"	41"	1.625 yd <sup>3</sup>
96"	880 lbs	35"	41"	2 yd <sup>3</sup>

## HIGH-CAPACITY LIGHT MATERIAL BUCKETS FOR SKID-STEER LOADERS



HIGH-CAPACITY LIGHT MATERIAL BUCKETS	ORDER CODE	SHIP WEIGHT (LBS)	LIST PRICE
84" high capacity light material/snow bucket (1.625 yd <sup>3</sup> ) 9 holes/9.75" spacing	102191	740	\$3,143
96" high capacity light material/snow bucket (2 yd <sup>3</sup> ) 9 holes/10.83" spacing	102333	880	\$3,550

Add Surcharge to All products @ .85%

## HIGH-DUMP BUCKET



- The Bradco® High-Dump bucket extends lift height by more than five feet! (60.5") compared to a standard general purpose bucket.
- The High-Dump bucket offers 113° of roll-out
- The bucket is designed for use with light-duty material
- Available in 60", 72", 84" and 96" widths

Specifications				
Width	Weight (approx)	Height	Depth	Capacity Heaped
60"	1000 lbs	32.3"	49.9"	1.00 yd <sup>3</sup>
72"	1170 lbs	32.3"	49.9"	1.20 yd <sup>3</sup>
84"	1275 lbs	32.3"	49.9"	1.50 yd <sup>3</sup>
96"	1359 lbs	32.3"	49.9"	1.70 yd <sup>3</sup>

## HIGH-DUMP BUCKETS FOR SKID-STEER LOADERS



	ORDER CODE	SHIP WEIGHT (LBS)	LIST PRICE
60" High-Dump Bucket (1.00 yd <sup>3</sup> ) 7 holes/9.00" spacing	122651	1100	\$5,380
72" High-Dump Bucket (1.19 yd <sup>3</sup> ) 7 holes/11.00" spacing	122619	1270	\$5,583
84" High-Dump Bucket (1.44 yd <sup>3</sup> ) 9 holes/9.75" spacing	122657	1375	\$5,793
96" High-Dump Bucket (1.68 yd <sup>3</sup> ) 16 holes/6.00" spacing	122660	1459	\$6,030
<b>OPTIONAL BOLT-ON CUTTING EDGE KIT</b>			
<b>INCLUDES BOE, GRADE 8 PLOW BOLTS, LOCK WASHERS &amp; NUTS</b>			
	ORDER CODE	SHIP WEIGHT (LBS)	LIST PRICE
60" (7 holes, 9.00" spacing)	15025	124	POR
72" (7 holes, 11.00" spacing)	15028	150	\$552
84" (9 holes, 9.75" spacing)	16183	203	POR
96" (16 holes, 6.00" spacing)	FFC10084	232	\$728
<b>OPTIONS</b>			
<b>INCLUDES ½" FLAT FACE COUPLERS</b>			
	ORDER CODE	SHIP WEIGHT (LBS)	LIST PRICE
60" hose kit	MTG1113-0022	14	\$442
80" hose kit	MTG1113-0903	18	\$541
88" hose kit	MTG1113-9783	21	\$570
96" hose kit	117285	23	\$600
*Hose Kits-Hoses from the bucket to the loader are not supplied. Hose packages available are listed above or the dealer can make up their own hoses.			

# BUCKETS

## LARGE FRAME SKID-STEER BUCKET

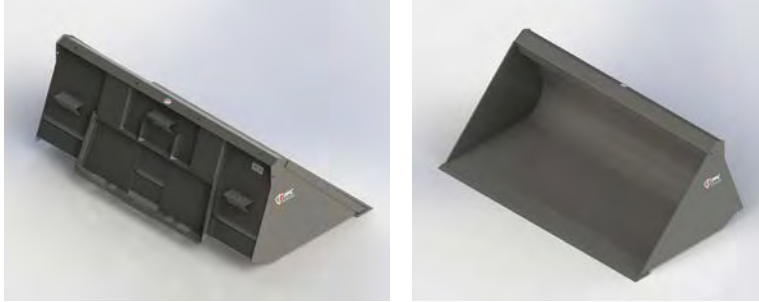

- Models for utility and dirt applications
- Higher strength and capacity for larger Skid-Steers
- Wear-resistant Pacal steel tapered cutting edge



**IMPORTANT:** FFC Skid-Steer buckets have a 70° angle on the back. This may increase or decrease the effective rollback and dump angles of your Skid-Steer. Specify Skid-Steer make and model when ordering.

Carrier Specifications	
Lift Capacity	Operating Weight
<9,000 lbs.	<11,000 lbs.

Specifications								
Model	Use	Weight (approx)	Width OD	Height	Depth	Leading Edge	Capacity Struck	Capacity Heaped
LAF0485	Utility	850 lbs	82.5"	31.9"	42.6"	31.3"	1.19 yd <sup>3</sup>	1.50 yd <sup>3</sup>
LAF0496	Utility	970 lbs	94.2"	31.9"	42.6"	31.3"	1.37 yd <sup>3</sup>	1.73 yd <sup>3</sup>

## LARGE FRAME SKID-STEER BUCKETS FOR SKID-STEER LOADERS



**INCLUDES: BUCKET AND UNIVERSAL SSL MOUNTING**

BUCKET	ORDER CODE	SHIP WEIGHT (LBS)	LIST PRICE
82.5" OD Large-Frame Skid-Steer Bucket	LAF0485-0022	850	\$3,059
94.2" OD Large-Frame Skid-Steer Bucket	LAF0496-0022	970	\$3,163
<b>OPTIONAL- REVERSIBLE CUTTING EDGE KIT INCLUDES BOE, GRADE 8 PLOW BOLTS, LOCK WASHERS &amp; NUTS</b>			
	ORDER CODE	SHIP WEIGHT (LBS)	LIST PRICE
For Bucket LAF0485 (9 holes, 9.75" spacing)*	15029	136	\$730
For Bucket LAF0496 (9 holes, 10.82" spacing)*	113984	157	\$737
<b>OPTIONAL- TOOTHBARS EXCLUSIVE TO FFC BUCKETS</b>			
	ORDER CODE	SHIP WEIGHT (LBS)	LIST PRICE
<b>Heavy-Duty Toothbar for Buckets without Bolt-On Edge</b>			
For Bucket LAF0485 with 10 teeth	10561	150	\$1,366
<b>Heavy-Duty Toothbar for Buckets with Bolt-On Edge</b>			
For Bucket LAF0496 with 10 teeth	10590	193	\$1,632
<b>Extra Heavy-Duty Toothbar for Buckets with Bolt-On Edge</b>			
For Bucket LAF0485 with 10 teeth	10564	183	\$2,202
For Bucket LAF0496 with 10 teeth	10592	191	\$1,932

## LIGHT MATERIAL LOADER BUCKETS



### LIGHT MATERIAL LOADER BUCKETS FOR COMPACT TRACTOR LOADERS WITH SKID-STEER LOADER INTERCHANGE



BUCKET	ORDER CODE	SHIP WEIGHT (LBS)	LIST PRICE
66" light material loader bucket* - heaped capacity .55yd <sup>3</sup> , struck capacity .43yd <sup>3</sup>	13426	450	\$2,000
72" light material loader bucket* - heaped capacity .61yd <sup>3</sup> , struck capacity .48yd <sup>3</sup>	307092	595	\$2,089
78" light material loader bucket* - heaped capacity .72yd <sup>3</sup> , struck capacity .55yd <sup>3</sup>	120897	614	\$2,372
84" light material loader bucket* - heaped capacity .78yd <sup>3</sup> , struck capacity .60yd <sup>3</sup>	120903	653	\$2,464

\*Includes bolt-on edge

Add Surcharge to all products 85%

# BUCKETS

## ROCK BUCKETS

**NEW PRODUCT**



- Reinforced tine tips resist bending from side loads
- Collect rocks, bricks & debris allowing the soil to sift through
- Removable bolt-in side plates for handling logs
- Grade 80 tine construction
- Bolt-in side plates
- Optional grapple kit (239600) to secure large loads (coming soon)

Carrier Specifications	
Lift Capacity	Operating Weight
<9,000 lbs.	<13,000 lbs.

Specifications						
Weight (approx)	Width OD	Height	Depth	Number of Tines	Tine Spacing	Tine Thickness
514 lbs	60"	22.5"	43.8"	19	3"	0.375"
559 lbs	66.63"	22.5"	43.8"	21	3"	0.375"
599 lbs	73.25"	22.5"	43.8"	23	3"	0.375"
670 lbs	79.88"	22.5"	43.8"	25	3"	0.375"
711 lbs	86.5"	22.5"	43.8"	27	3"	0.375"

## ROCK BUCKETS FOR SKID-STEER LOADERS



**i** INCLUDES: BUCKET, SIDE PLATES, AND MOUNTING

UNIVERSAL SKID-STEER MOUNT	ORDER CODE	SHIP WEIGHT (LBS)	LIST PRICE
60" bucket, 3" tine spacing	32260-0022	534	\$2,385
66" bucket, 3" tine spacing	32266-0022	579	\$2,485
72" bucket, 3" tine spacing	32272-0022	619	\$2,585
78" bucket, 3" tine spacing	32278-0022	690	\$2,745
84" bucket, 3" tine spacing	32284-0022	731	\$2,895
OPTIONS	ORDER CODE	SHIP WEIGHT (LBS)	
replacement side plate kit (2 plates + hardware)	239509	30	\$158

## ROCK BUCKETS CONT.



- Available with or without single piece construction universal mount
- Optional bolt-on universal skid-steer and tractor mounts available
- Offers maximum production & covers typical wheel bases
- Collect rocks, bricks & debris allowing the soil to sift through
- Optional 60" grapple kit for 1.13 diameter tines, opens to 55"

Carrier Specifications	
Lift Capacity	Operating Weight
<10,000 lbs.	<32,000 lbs.

Specifications						
Weight (approx)	Width OD	Height	Depth	Number of Tines	Tine Spacing	Tine Diameter
680 lbs	66"	22"	43"	22	2"	1.13"
555 lbs	66"	22"	43"	16	3"	1.13"
742 lbs	75"	22"	43"	24	2"	1.13"
625 lbs	75"	22"	43"	18	3"	1.13"
692 lbs	84"	22"	43"	20	3"	1.13"

## ROCK BUCKETS FOR SKID-STEER LOADERS



**INCLUDES: BUCKET AND MOUNTING**

UNIVERSAL SKID-STEER MOUNT		ORDER CODE	SHIP WEIGHT (LBS)	LIST PRICE
66" bucket, 2" tine spacing		16294	680	\$4,387
66" bucket, 3" tine spacing		89627	555	\$3,551
75" bucket, 2" tine spacing		16297	742	\$4,497
75" bucket, 3" tine spacing		89646	625	\$4,054
84" bucket, 3" tine spacing		16503	692	\$4,267
OPTIONS		ORDER CODE	SHIP WEIGHT (LBS)	LIST PRICE
<b>Grapple Assembly</b>				
grapple assembly for Skid-Steer mounts		104950	490	\$3,328
<b>Hydraulic Kit for Grapple</b>				
75" hoses with flat face couplers		105845	13	\$441
87" hoses with flat face couplers		105712	15	\$420

## ROCK BUCKETS FOR EURO/GLOBAL MOUNTS



**LIST PRICE INCLUDES: BUCKET AND MOUNTING**

EURO/GLOBAL MOUNTS		ORDER CODE	SHIP WEIGHT (LBS)	LIST PRICE
75" rock bucket with euro / global mount, 2" tine spacing		111771	635	\$3,625
75" rock bucket with euro / global mount, 3" tine spacing		111772	516	\$3,344
84" rock bucket with euro / global mount, 3" tine spacing; heavy duty tine		111773	1480	\$7,381
93" rock bucket with euro / global mount, 3" tine spacing; heavy duty tine		111774	1658	\$9,256
OPTIONS		ORDER CODE	SHIP WEIGHT (LBS)	LIST PRICE
<b>Hydraulic Kit for Grapple</b>				
75" hoses with flat face couplers		105845	13	\$441
87" hoses with flat face couplers		105712	15	\$420

# BUCKETS

## ROCK BUCKETS CONT.

### ROCK BUCKETS FOR COMPACT TRACTORS



**INCLUDES: BUCKET AND MOUNTING**

COMPACT TRACTOR MOUNTS	ORDER CODE	SHIP WEIGHT (LBS)	LIST PRICE
55" rock bucket 2" tine spacing	108603	300	\$2,954

### ROCK BUCKETS FOR WHEEL LOADERS



**INCLUDES: BUCKET AND MOUNTING**

WHEEL LOADER MOUNTS	ORDER CODE	SHIP WEIGHT (LBS)	LIST PRICE
<b>84" Rock Bucket 3" tine spacing, 1.62" diameter tines</b>			
Case 570K pin-on	105021	1688	\$7,829
Case 570L/570M/570N	119796	1688	\$7,573
Case 680	12934	1705	\$7,573
Cat IT/TH 84" wide 3" tine spacing	102123	1725	\$7,973
John Deere 840	12898	1540	\$7,573
John Deere 244J	13231	1795	\$7,573
New Holland LW-50	12834	1800	\$7,573
Volvo L30-L35	13231	1795	POR
FFC QCP 7000 MTG 84" x 1.63" tine spacing	114356	1626	\$7,381
<b>94" Rock Bucket</b>			
JCB 214 pin-on	12810	1900	\$9,785

### ROCK BUCKETS NO MOUNT



**INCLUDES: BUCKET ONLY**

BUCKET ONLY	ORDER CODE	SHIP WEIGHT (LBS)	LIST PRICE
66" bucket, 2" tine spacing no mount	16354	675	\$2,453
66" bucket, 3" tine spacing no mount	89666	550	\$2,153
75" bucket, 2" tine spacing no mount	16356	736	\$2,950
75" bucket, 3" tine spacing no mount	89675	619	\$2,680
84" bucket, 3" tine spacing no mount	16501	651	\$2,930
OPTIONS	ORDER CODE	SHIP WEIGHT (LBS)	LIST PRICE
<b>Hydraulic Kit for Grapple</b>			
75" hoses with flat face couplers	105845	13	\$441
87" hoses with flat face couplers	105712	15	\$420
BOLT-ON MOUNT	ORDER CODE	SHIP WEIGHT (LBS)	LIST PRICE
bolt-on universal Skid-Steer mount no pins	88730	99	\$787
bolt-on universal loader mount 1.00" diameter pin	88732	99	\$406
bolt-on universal loader mount 1.25" diameter pin	102503	99	\$438

# COLD PLANERS



# COLD PLANERS

## COLD PLANER



- Planetary drive delivers high torque
- High rear spoil clearance to prevent recirculation of material
- Protective shields for hydraulic & electrical components
- Efficient piston drive motor
- Optional water tank available with adjustable mounting brackets to fit most skid-steer loaders

Carrier Specifications	
Lift Capacity	Operating Weight
<10,000 lbs.	<20,000 lbs.

Specifications							
Model #	Weight (Approx)	Hydraulic Flow	Flow Range	Overall Width	Overall Height	Planing Width	Planing Depth
SP300	1500 lbs	standard	12-22 gpm	52"	32"	12"	0"-5"
HP400	2175 lbs	high	22-40 gpm	65"	35"	16"	0"-5"
HP450	2200 lbs	high	22-40 gpm	65"	35"	18"	0"-5"
HP600	2400 lbs	high	22-40 gpm	65"	35"	24"	0"-5"
HP750	2600 lbs	high	22-40 gpm	65"	35"	30"	0"-5"
HP1000	3100 lbs	high	31-40 gpm	65"	35"	40"	0"-5"

## COLD PLANER FOR SKID-STEER LOADERS



**TO ORDER: CHOOSE AN ASSEMBLY, MOTOR, OEM IN-CAB CONTROL AND COUPLERS (QD SET). HOSES ARE INCLUDED. CONTACT FACTORY FOR INFORMATION ON DIRECT CONNECT TO SKID-STEER (833) 723-1843**

COLD PLANER ASSEMBLY	ORDER CODE	SHIP WEIGHT (LBS)	LIST PRICE
<b>Standard Flow 12 - 22 GPM</b>			
SP300 12" hydraulic side-shift/mechanical tilt/depth (complete - controls not required)	101197	1450	\$14,216
SP300 12" hydraulic side-shift/tilt/depth (complete with control handle assembly 118650)	101196	1500	\$16,429
<b>Four Function In-Cab, High Flow (requires hydraulic motor)</b>			
HP400 16" hydraulic side-shift/tilt/depth (18" frame)	100793	2175	\$23,552
HP450 18" hydraulic side-shift/tilt/depth	100265	2200	\$22,872
HP600 24" hydraulic side-shift/tilt/depth	100266	2400	\$27,377
HP750 30" hydraulic side-shift/tilt/depth	100267	2600	\$30,730
HP1000 40" hydraulic side-shift / tilt / depth (requires motor P/N 17778)	103030	3100	\$37,374
<b>Three Function In-Cab (right depth, left depth, sideshift) with Selector Valve on Planer (changes sideshift to tilt), High Flow (requires hydraulic motor)</b>			
HP400 16" hydraulic side-shift/tilt/depth (18" frame)	114436	2175	\$24,286
HP450 18" hydraulic side-shift/tilt/depth	114437	2220	\$25,338
HP600 24" hydraulic side-shift/tilt/depth	114438	2400	\$28,544
HP750 30" hydraulic side-shift/tilt/depth	114439	2600	\$31,546
HP1000 40" hydraulic side-shift / tilt / depth (requires motor P/N 17778)	114440	3100	\$39,983

HYDRAULIC MOTOR	ORDER CODE	SHIP WEIGHT (LBS)	LIST PRICE
22 to 25 GPM hydraulic motor	17776	25	\$3,144
26 to 30 GPM hydraulic motor	17777	21	\$3,334
31 to 44 GPM hydraulic motor	17778	25	\$3,488

## COLD PLANER FOR SKID-STEER LOADERS CONT.

OEM IN-CAB CONTROLS	ORDER CODE	SHIP WEIGHT (LBS)	LIST PRICE
<b>4 Function High Flow Planers Only</b>			
Bobcat 7-pin - Pilot (12 button) controls	07-9548 + 239039		\$1,294
Bobcat 7-pin - Toolcat, Verahandler, and Hand/Foot controls	07-9602 + 114874		\$2,042
Bobcat, Ditch Witch, Gehl, Mustang, JCB, Volvo	114874	1	\$602
CNH, Kubota SVL Series 2, Kubota SSV-2	116745	1	\$614
John Deere	114969	1	\$614
John Deere P-Series	239596	1	\$682
Kubota (must have the Kubota Multi-Function Control Kit), JCB, Volvo, Takeuchi	118470	1	\$678
Bradco Control Handle Assembly	115403	15	\$2,616
CAT D-Series	120262	1	\$614
<b>3 Function with Selector Valve High Flow Planers Only</b>			
Bobcat, CNH, Gehl, JCB, Mustang, Volvo, Wacker	19644	1	\$975
John Deere	108618	1	\$975
Kubota (must have the Kubota Multi-Function Control Kit)	19644	1	\$975
Bradco Control Handle Assembly	118650	15	\$2,477
Takeuchi	120337	1	\$621
CAT D-Series	122128	1	\$744
<b>Q.D. SETS</b>			
	ORDER CODE	SHIP WEIGHT (LBS)	LIST PRICE
0.50" body with 0.38" Male Drain	119996	5	\$277
0.50" body with 0.38" Female Drain	119997	5	\$311
0.62" body with 0.38" Male Drain	119998	5	\$454
0.62" body with 0.38" Female Drain	119999	5	\$558
0.75" body with 0.25" Male Drain	120000	5	\$572
0.75" body with 0.38" Male Drain	120001	5	\$583
0.75" body with 0.38" Female Drain	120002	5	\$596
0.75" body with 0.50" Male Drain	120003	5	\$425
<b>OPTIONS</b>			
	ORDER CODE	SHIP WEIGHT (LBS)	LIST PRICE
30 gal. Universal Mount Tank, 12V pump with out electrical control box	105720	60	\$2,204
30 gal. Universal Mount Tank, 12V pump with electrical control box	104444	65	\$2,754
2.5" standard flow slot cutter	100641	90	\$3,285
2.5" high flow slot cutter	100642	120	\$3,476
4" high flow slot cutter	100643	135	\$3,187
6" high flow slot cutter	100644	150	\$4,202
Hose Extension Kit	119419	10	\$367
<b>REPLACEMENT PARTS</b>			
	ORDER CODE	SHIP WEIGHT (LBS)	LIST PRICE
Pick Replacement Kit, RP18 12" Drum (37 Picks)	120708		\$868
Pick Replacement Kit, RP18 18" Drum (45 Picks)	120702		\$916
Pick Replacement Kit, RP18 24" Drum (57 Picks)	120704		\$1,162
Pick Replacement Kit, RP18 30" Drum (69 Picks)	120706		\$1,615
Pick Replacement Kit, RP18 40" Drum (89 Picks)	123827		\$1,286
Pick Replacement Kit, G.p. (100 Picks)	107013		\$1,544
Pick Replacement Kit, Concrete (100 Picks)	107012		\$1,804
Pick Replacement Kit, G.p. (50 Picks)	102058	30	\$788
Pick Replacement Kit, Concrete (50 Picks)	102059	30	\$988

REPLACEMENT PARTS CONTINUED NEXT PAGE

# COLD PLANERS

## COLD PLANER FOR SKID-STEER LOADERS CONT.

REPLACEMENT PARTS	ORDER CODE	SHIP WEIGHT (LBS)	LIST PRICE
Pick General Purpose	18546		\$24
Pick Concrete	18547		\$34
Pick Asphalt RP18	LAF9390-0000		\$24
Puller, Pick Extracting Tool- 1761401	100213		\$238
12" Standard Drum Assembly-Incl Standard General Purpose Picks	19706	155	\$3,981
16" High Flow Drum Assembly-Incl Standard General Purpose Picks	18534	335	\$7,469
18" High Flow Drum Assembly-Incl Standard General Purpose Picks	18535	350	\$6,528
24" High Flow Drum Assembly-Incl Standard General Purpose Picks	18524	400	\$9,488
30" High Flow Drum Assembly-Incl Standard General Purpose Picks	19712	660	\$12,246
40" High Flow Drum Assembly-Incl Standard General Purpose Picks	101080	720	\$17,837
Electric Control Box	15757	5	\$566
Replacement Electric Control Handle	100434	15	\$1,183
Motor 2.00 Cid 15t 2bolt-B (22-25 Gpm)	17776		\$3,144
Motor 2.48 Cid 15t 2bolt-B (26-30 Gpm)	17777		\$3,334
Motor 3.00 Cid 15t 2bolt-B (31-44 Gpm)	17778		\$3,488
Seal Kit, Motor - All Motors	45845		\$372

## COLD PLANER SERIES II



- Side shifts 24" left or right to cut next to obstacles
- High flow models feature planetary gearbox drive for increased torque and durability
- Two sizes available for standard-flow Skid-Steers, six sizes available for high-flow Skid-Steers

Carrier Specifications	
Lift Capacity	Operating Weight
<10,000 lbs.	<20,000 lbs.



**NOTE:** All replacement hydraulic hoses and fittings must have a minimum rated working pressure of 4000 PSI.

Specifications									
Model #	Flow	Weight (Approx)	Cutting Width	Cutting Depth	Tilt	Sideshift	Pick Qty.	PSI Range	GPM Range
LAF5412	Std	1135 lbs	12"	0-5.00"	±15°	24"	36	2200-3400	13-25
LAF5413	Std	1225 lbs	16"	0-5.00"	±15°	24"	44	2200-3400	16-25
LAF5416	High	1510 lbs	16"	0-6.00"	±15°	24"	48	2200-5000	24-45
LAF5418	High	1560 lbs	18"	0-6.00"	±15°	24"	52	2200-5000	26-45
LAF5420	High	1610 lbs	20"	0-6.00"	±15°	24"	56	2200-5000	26-45
LAF5424	High	1690 lbs	24"	0-6.00"	±15°	24"	64	2200-5000	28-45
LAF5430	High	1855 lbs	30"	0-6.00"	±12.5°	24"	76	2200-5000	28-45
LAF5436	High	2015 lbs	36"	0-6.00"	±10°	24"	88	2200-5000	31-45

COLD PLANER SERIES II CONTINUED NEXT PAGE

## COLD PLANER SERIES II CONT.

### COLD PLANER SERIES II FOR SKID-STEER LOADERS CONT.



**INCLUDES: COLD PLANER, UNIVERSAL SSL MOUNTING AND CONTROL BOX. HOSES AND COUPLERS INCLUDED FOR SKID-STEERS ONLY. TO ORDER CHOOSE COLD PLANER, MOUNT AND OEM IN-CAB CONTROLS.**

COLD PLANER		ORDER CODE	SHIP WEIGHT (LBS)	LIST PRICE
<b>CHECK LOADER CAPACITY BEFORE ORDERING</b>				
<b>Standard-Flow Cold Planer</b>				
12" Standard-Flow Cold Planer (no control box required)	LAF5412-0022	1235	\$15,681	
16" Standard-Flow Cold Planer (no control box required)	LAF5413-0022	1325	\$21,760	
<b>High-Flow Cold Planer (To be used on High-Flow SSL Loaders. Call FFC for availability)</b>				
16" High-Flow Cold Planer	LAF5416-0022	1610	\$24,736	
18" High-Flow Cold Planer	LAF5418-0022	1660	\$25,596	
20" High-Flow Cold Planer	LAF5420-0022	1710	\$26,500	
24" High-Flow Cold Planer	LAF5424-0022	1780	\$27,595	
30" High-Flow Cold Planer	LAF5430-0022	1955	\$35,007	
36" High-Flow Cold Planer	LAF5436-0022	2115	\$40,762	
<b>MOUNTING - ADDITIONAL COST MAY APPLY</b>		ORDER CODE	SHIP WEIGHT (LBS)	LIST PRICE
Contact Customer Service at (833) 723-1843				
<b>OEM IN-CAB CONTROLS</b>		ORDER CODE	SHIP WEIGHT (LBS)	LIST PRICE
<b>FFC 3-Line Cold Planer Electrical Controls</b>				
Standard Control Box	07-10013	1	\$536	
Wire Harness (multi function in cab controls) for CNH, JCB, Bobcat, Mustang, Kubota, Takeuchi, Volvo 14 Pin-8 Pin	LAF9360-0000	1	\$268	
Wire harness for CNH (8-pin rectangular)	LAF9393	1	\$222	
Caterpillar D XPS (14-pin)	07-8373	1	\$1,069	
Caterpillar D XHP (14-pin)	07-8378	1	\$1,347	
John Deere pre-D with 8-button controls (14-pin)	LAF9361	1	\$362	
John Deere with EH controls & D/E series (14-pin)	07-7626	1	\$711	
Kubota (must have the Kubota Multi-Function Control Kit)	19644	1	\$975	
<b>FFC 5-Line Cold Planer Electrical Controls</b>				
Standard Control Box	07-10019	15	\$365	
Case (14-pin)	LAF9360-0000	15	\$268	
Wire harness for CAT pre-B (8-pin Deutsch)	07-10021	15	\$372	
Caterpillar B/C series (8-pin)	07-10170	15	\$553	
Komatsu (8-pin)	07-10057	15	\$585	
Volvo (14-pin)	LAF9360-0000	15	\$268	
<b>REPLACEMENT PARTS</b>		ORDER CODE	SHIP WEIGHT (LBS)	LIST PRICE
Pick Asphalt RP18	LAF9390-0000	1	\$24	
Pick Heavy Duty Cement	07-10005	1	\$27	
Kit Bit Concrete FFC Cold Planer 4-Pack	07-10005-4		\$113	
Service Tool - Pick Removal	LAF9326-0000	5	\$271	
Replacement Wheel Kit For Cold Planers	LAF5450-0000	11	\$245	
Motor Char-Lynn 24 Cu In - Std Flow	LAF4697-0000		\$3,675	
Motor Piston 2.48 Cid.50 13t 2bolt-B - High Flow	03-10122		\$3,220	
Kit Seal F/03-10122	03-6142		\$593	
Kit Seal F/LAF4697-0000	LAF4715-0000		\$250	

# CONCRETE CHUTER / CONCRETE CLAW

## CONCRETE CHUTER



- Half or three-quarter yard

Specifications					
Model	Weight (approx)	Length w/o Chute	Length w/ Chute	Width	Height OD
11050	450 lbs	36"	65"	58"	28"
11075	520 lbs	39"	68"	58"	31"

## CONCRETE CHUTER FOR SKID-STEER LOADERS



CONCRETE CHUTER	ORDER CODE	SHIP WEIGHT (LBS)	LIST PRICE
.5 yard Concrete Chuter	11050-0022	488	\$3,670
.75 yard Concrete Chuter	11075-0022	550	\$3,699

## CONCRETE CLAW



- Excellent attachment for removing concrete on sidewalks, driveways or any construction site
- End plates and 1.5" Tooth Shank are made with high strength T-1 steel
- 1" x 8" wear resistant steel tapered cutting edge

Carrier Specifications	
Lift Capacity	Operating Weight
<10,000 lbs.	<32,000 lbs.

Specifications					
Model	Weight (approx)	Working Width	Working Depth	Rear Opening Height	Height
10024	442 lbs	24"	48"	7.5"	21"

## CONCRETE CLAW FOR SKID-STEER LOADERS



**INCLUDES: CONCRETE CLAW & UNIVERSAL SSL MOUNTING. TO ORDER CHOOSE CONCRETE CLAW AND MOUNT.**

CONCRETE CLAW	ORDER CODE	SHIP WEIGHT (LBS)	LIST PRICE
<b>CHECK LOADER CAPACITY BEFORE ORDERING</b>			
Concrete Claw	10024-0022	575	\$2,840

MOUNTING - ADDITIONAL COST MAY APPLY	ORDER CODE	SHIP WEIGHT (LBS)
--------------------------------------	------------	-------------------

Contact Customer Service at (833) 723-1843

OPTIONAL- REPLACEABLE PARTS	ORDER CODE	SHIP WEIGHT (LBS)	LIST PRICE
Replaceable points for 1-1/2" shank (cast)	88893	3	\$24
Rubberized flex pin	88894	1	\$10

NOTE: Shipping weights vary depending on loader mounting and packaging.

## COUPLER - TOOL CARRIER, QCP 7000 - MANUAL



- Maintains loader breakout, dump and rollback
- Change attachments quickly and easily with the 4-point hook-up system
- Allows clear line of site; operator can see positive hook-up

Carrier Specifications	
Lift Capacity	Operating Weight
<10,000 lbs.	<32,000 lbs.

## COUPLER - QCP 7000 TOOL CARRIER, MANUAL FOR TRACTOR LOADERS/BACKHOES



**INCLUDES: TOOL CARRIER AND MOUNTING. HOSES AND COUPLERS INCLUDED FOR SKID-STEERS ONLY. TO ORDER CHOOSE CARRIER AND MOUNTING. FITS MOST CASE, NEW HOLLAND AND FORD TLB'S. MANUAL QUICK ATTACH ONLY AVAILABLE THROUGH FFC & HYDRAULIC QUICK ATTACH ONLY AVAILABLE THROUGH CNH**

QCP 7000 TOOL CARRIER CHECK LOADER CAPACITY BEFORE ORDERING			
	ORDER CODE	SHIP WEIGHT (LBS)	LIST PRICE
Quick Attach Tool Carrier (Manual) F/CASE 570 L, M, N	LAF1721-0737	325	\$4,637
Quick Attach Tool Carrier (Manual) F/FORD 555 E STD,NH B95C	LAF1721-0892	280	\$4,466
Quick Attach Tool Carrier (Manual) F/FORD 555C	LAF1721-0224	280	\$4,466
Quick Attach Tool Carrier (Manual) F/NH LB 115, B95BTC	LAF1721-0983	280	\$4,466
Quick Attach Tool Carrier (Manual) F/FORD 445 C STD	LAF1721-0210	280	\$3,156
Quick Attach Tool Carrier (Manual) F/CASE 580 K	LAF1721-0087	280	\$4,466
Quick Attach Tool Carrier (Manual) QA F/CASE 580C-D-E	LAF1721-0083	280	\$4,466

NOTE: Other mountings available - LIST PRICE available upon request

MOUNTING ADDITIONAL COST MAY APPLY		
	ORDER CODE	SHIP WEIGHT (LBS)
Contact Customer Service at (833) 723-1843		

OPTIONS			
	ORDER CODE	SHIP WEIGHT (LBS)	
<b>QCP 7000 - Mounting Ears (Field Install) Required for attachments that do not have the FFC Quick Coupler Mounting</b>			
Mounting ears to convert existing buckets and attachments	LAF1723-0000	302	\$1,587

NOTE: Shipping weights vary depending on loader mounting and packaging.

# DOZER BLADES

## DOZER BLADE



- Available in 84" and 96"
- Hydro-electric controlled angle and tilt, using only one loader valve
- Angle 30° right or left off center
- Tilt 10° off horizontal both directions
- Tilt indicator visible from operator's seat

### Specifications

Weight (approx)	Overall Width	Overall Height	Overall Length	Angle left/right	Tilt
1300 lbs	84"	30"	37"	30°	10°
1400 lbs	96"	30"	37"	30°	10°

## DOZER BLADES FOR SKID-STEER LOADERS



**INCLUDES: DOZER BLADE. HOSES AND UNIVERSAL FLAT FACE COUPLERS INCLUDED.**

DOZER BLADE	ORDER CODE	SHIP WEIGHT (LBS)	LIST PRICE
84" dozer blade	88861	1300	\$9,228
96" dozer blade	89681	1400	\$9,436

ADAPTER HARNESS FOR IN-CAB CONTROL (REQUIRES ONE OF THE BELOW)	ORDER CODE	SHIP WEIGHT (LBS)	LIST PRICE
Control box w/ power lead	28-10754	5	\$383
7-pin for Bobcat	07-9548	5	\$985
Wire Harness (multi function in cab controls) for CNH, JCB, Bobcat, Mustang, Kubota, Takeuchi, Volvo 14 Pin-8 Pin	LAF9360-0000	5	\$268
14 pin - 8 pin for CAT XPS D	119740	5	\$770
14 pin - 8 pin for CAT XHP D	119741	5	\$784
8-pin, Fits F2-H Series, for CAT B and C	07-10170	5	\$553
8-pin for Komatsu	07-10057	5	\$585
14-pin, Fits All Series, for John Deere-8 button	LAF9361	5	\$362

## FLAIL MOWERS



- Cuts 4" trees and heavy brush. Can cut up to 6" trees as needed
- Engineered for maximum performance and service life
- Allows operator to mow in both directions and control direction of cut material
- Available with multiple motors and mounts to fit 3-10 ton excavators

Specifications									
Model	Excavator Size (metric ton)	Cutting Width	Housing Width	Operating Weight w/ mount	Hydraulic Flow	Pressure	Rotational Speed	Number of Blade Stands	Cutting Capacity
FME30 Standard	3.0-6.0	28.5"	32"	880 lbs	8-28 gpm	4000 psi	1800-2200 rpm	8	4"
FME30 Thumb Ready	3.0-6.0	28.5"	32"	905 lbs	8-28 gpm	4000 psi	1800-2200 rpm	8	4"
FME40 Thumb Ready	6.0-10.0	38.5"	42"	1,225 lbs	17-40 gpm	5000 psi	1800-2200 rpm	10	4"



- **Operating weight in metric tons will determine if the FME30 or FME40 is appropriate. FME30 = 3t-6t, FME40 = 6t-10t**
- **Lift over side capacity at maximum reach at ground level - this is where the attachment will most likely be while it is working. This weight capacity needs to be suitable for the size and type of flail being considered. Sometimes a 3.5t excavator, even though it is in the operating weight range, does not have enough lift over side capacity to be able to lift the flail mower safely at max reach. The lift over side at max reach information is difficult to find as many OEM's don't publish this information so sometimes we may need the dealer to assist us in gathering this info. This is often the case with the smaller 3t-4t excavators.**
- **Auxiliary flow (flow available to the attachment) – this will determine the appropriate motor group to use.**
- **Case drain is required.**

## FLAIL MOWERS FOR EXCAVATORS





**INCLUDES: FLAIL MOWER ASSEMBLY. SHIPS WITHOUT HOSES AND COUPLERS DUE TO VARIATIONS BETWEEN MACHINES WITH REGARDS TO HYDRAULIC COUPLER PLACEMENT. TO ORDER: CHOOSE FLAIL MOWER ASSEMBLY AND MOUNT.**

COMMONLY CONFIGURED ITEMS		LIST PRICE
30" Excavator Flail Mower Standard w/ GPM Range 14-16	23130D-E0228	\$13,370
30" Excavator Flail Mower Standard w/ GPM Range 17-22	23130E-E0852	\$13,255
30" Excavator Flail Mower Standard w/ GPM Range 22-28	23130F-E0153	\$13,148
30" Excavator Flail Mower TR w/ GPM Range 14-16 (thumb saddle ordered separately)	23131D-E1091	\$16,101
30" Excavator Flail Mower TR w/ GPM Range 17-22 (thumb saddle ordered separately)	23131E-E5057	\$16,443
30" Excavator Flail Mower TR w/ GPM Range 22-28 (thumb saddle ordered separately)	23131F-E0153	\$16,203
40" Excavator Flail Mower TR w/ GPM Range 17-22 (thumb saddle ordered separately)	23140E-E0081	\$18,540
40" Excavator Flail Mower TR w/ GPM Range 22-28 (thumb saddle ordered separately)	23140F-E0333	\$18,792
40" Excavator Flail Mower TR w/ GPM Range 27-33 (thumb saddle ordered separately)	23140G-E0333	\$19,331
EXCAVATOR FLAIL MOWER ASSEMBLY (HOSES AND COUPLERS NOT INCLUDED)		LIST PRICE
Standard - No Thumb Capacity		
30" Excavator Flail Mower Standard w/ GPM Range 8-9	23130A	\$12,865
30" Excavator Flail Mower Standard w/ GPM Range 10-11	23130B	\$12,865
30" Excavator Flail Mower Standard w/ GPM Range 12-14	23130C	\$13,383
30" Excavator Flail Mower Standard w/ GPM Range 14-16	23130D	\$13,383
30" Excavator Flail Mower Standard w/ GPM Range 17-22	23130E	\$13,850
30" Excavator Flail Mower Standard w/ GPM Range 22-28	23130F	\$14,103

# FLAIL MOWERS

## FLAIL MOWERS FOR EXCAVATORS CONT.

EXCAVATOR FLAIL MOWER ASSEMBLY (HOSES AND COUPLERS NOT INCLUDED)	ORDER CODE* WITH SUFFIX CODE BELOW FOR MOUNT	SHIP WEIGHT (LBS)	LIST PRICE
---	--	----------------------	------------

Thumb Ready			
30" Excavator Flail Mower TR w/ GPM Range 8-9 (thumb saddle ordered separately)	23131A	905	\$15,960
30" Excavator Flail Mower TR w/ GPM Range 10-11 (thumb saddle ordered separately)	23131B	905	\$16,260
30" Excavator Flail Mower TR w/ GPM Range 12-14 (thumb saddle ordered separately)	23131C	905	\$16,334
30" Excavator Flail Mower TR w/ GPM Range 14-16 (thumb saddle ordered separately)	23131D	905	\$16,475
30" Excavator Flail Mower TR w/ GPM Range 17-22 (thumb saddle ordered separately)	23131E	905	\$16,491
30" Excavator Flail Mower TR w/ GPM Range 22-28 (thumb saddle ordered separately)	23131F	905	\$16,777

EXCAVATOR FLAIL MOWER ASSEMBLY (HOSES AND COUPLERS NOT INCLUDED)	ORDER CODE* WITH SUFFIX CODE BELOW FOR MOUNT	SHIP WEIGHT (LBS)	LIST PRICE
---	--	----------------------	------------

Thumb Ready cont.			
40" Excavator Flail Mower TR w/ GPM Range 17-22 (thumb saddle ordered separately)	23140E	1225	\$16,615
40" Excavator Flail Mower TR w/ GPM Range 22-28 (thumb saddle ordered separately)	23140F	1225	\$18,266
40" Excavator Flail Mower TR w/ GPM Range 27-33 (thumb saddle ordered separately)	23140G	1225	\$18,728
40" Excavator Flail Mower TR w/ GPM Range 32-40 (thumb saddle ordered separately)	23140H	1225	\$18,810

OPTIONS	ORDER CODE	SHIP WEIGHT (LBS)	LIST PRICE
---------	------------	----------------------	------------

Saddles for 30" and 40" Thumb Ready Flail Mowers			
Thumb Saddle (Factory Install)	28-10747	90	\$1,084
Thumb Saddle (Field Install)	28-10833	90	\$993

EXCAVATOR MOUNTS (ONE REQUIRED - CONTACT FACTORY FOR MOUNTS NOT LISTED)				
MAKE	MODELS	PIN-ON / COUPLER	SUFFIX CODE	SHIP WEIGHT (LBS)

Bobcat	331/334/430 ZHS	Pin-on	-E0331	120
Bobcat	E80/E85 M	Pin-on	-E1075	120
Bobcat	442	Pin-on	-E0442	120
C&P	027 QH	Coupler	-E0852	120
C&P	030 QH	Coupler	-E0333	120
Case	CX55B MTS/CX50B	Pin-on	-E2051	120
Case	CX55		-E2051C	120
Case	CX37C/CX33C	Pin-on	-E0535	120
Case	CX60/CX60C/CX57C	Pin-on	-E1060	120
Case	CX36/CX36B/CX31	Pin-on	-E3354	120
Case	CX80C	Pin-on	-E1600	120
Case	9007B/CX 75SR/9007/CX 75C/CX80	Pin-on		120
Case	580M/580SL/580K/580L/590/680/580SM	Pin-on	-R0580	120
Case	580SN/580N/580EV/580N EP	Pin-on	-R3580	120
CAT	304/304C/304C CR/305.5/305.5D/305.5D CR/305.5E/3.5.5E CR/305.5E2/305C CR/305E/305E CR/305E2 CR/306 CR	Pin-on	-E0304	120
CAT	420F/415F/415F2/416D/416E/416F/416F2/420D/420E/420F/420F2/424D/428D/428E/428F/430D/430E/430F/430F2/432D/432E/432F/438D/442D	Pin-on	-R0430	120
CAT	304 E2 CR/303 CR/303.5/303.5C/303.5C CR/303.5D/303.5D CR/303.5E/303.5E2 CR/303C/304D/304E/304E CR/304E2	Pin-on	-E3303	120
CAT	307/307B/308B/307C/308/E70B	Pin-on	-E0070	120
CAT	308 E2 CR SB/307E2/308E CR SB/307D/307E/308E/308E2 CR/308D	Pin-on	-E1308	120
Daewoo	SOLAR 75-V	Pin-on	-E1075	120
Doosan	DX85R/DX89R-7/DX85R-3/DX80R/DX85-3	Pin-on	-E1075	120
Gehl	ME3003/353/303/373/383Z	Pin-on	-E0223	120
Gehl	503Z	Pin-on	-E0503	120
Gehl	Z45/Z55	Pin-on	-E0050	120
Gehl	100M/Z80	Pin-on	-E1171	120
Geith	S9	Coupler	-E1601	120

FLAIL MOWER EXCAVATOR MOUNTS CONTINUED NEXT PAGE

## FLAIL MOWERS FOR EXCAVATORS CONT.

EXCAVATOR MOUNTS (ONE REQUIRED - CONTACT FACTORY FOR MOUNTS NOT LISTED)				
MAKE	MODELS	PIN-ON / COUPLER	SUFFIX CODE	SHIP WEIGHT (LBS)
Hitachi	ZX75US-5/EX 80U/EX 60-5/ZX85USB-5/ZX80US-3/EX80/ZX75US-3/ ZX80/EX 75US		-E0081	120
Hitachi	ZX50U-5/ZX50U-2/EX50U/ZX50U-3/EX45-2/EX40-2	Pin-on	-E5050	120
Hitachi	ZX50U-5/ZX60USB-3/ZX50U/ZX50U-2/ZX50U-3/ZX60USB-5	Coupler	-E0153	120
Hyundai	R35Z-9/R35Z-9A	Pin-on	-E0535	120
Hyundai	R60CR-9A/R55-9A/R60-9S/R55-9/HW60/RC60CR-9/HX60/R60W-9S	Pin-on	-E1060	120
Hyundai	R80CR-9/HX85	Pin-on	-E0809	120
Ingersoll Rand	ZX-75	Pin-on	-E0442	120
JCB	JZ 70/JS 70/JS 85LC/JS 85	Pin-on		120
JCB	8045 ZTS/8040 ZTS/8055/8050	Pin-on	-E8045	120
JCB	8052/100C/214/214E/214S/215/215E/215S/217/8060/8065/800/85Z/86C/ 90Z	Pin-on	-E0214	120
JCB	3CX/3CX-14/3CX-4/3CX-15 SUPER /3CX-14 SUPER/4CX-4	Pin-on	-R0214	120
John Deere	35 ZTS/ZX35U-5/ZX35U-3/ZX35U-2/ZX27U-3/ZX27U-2/ZX26U-5/35G ZTS/35D ZTS/35C ZTS/35 ZTS/27D ZTS/27C ZTS/26G ZTS/110	Coupler	-E0228	120
John Deere	310SJ/310SG/310SK/310SL/3155SG/315SJ/315SK/315SL/320P/410G/410J/4 10K/410L/410P	Pin-on	-R0010	120
John Deere	85/85G/80C/80/75D/85D		-E0081	120
John Deere	50G/50C/50 ZTS/50D	Pin-on	-E5050	120
John Deere	50D ZTS/60G ZTS/50 ZTS/50G ZTS/60P	Coupler	-E0153	120
John Deere	50	Pin-on	-E0050	120
Kobelco	SK50 SR-3/SK55 SRX-6E/SK45 SR-6E/SK50 SR-5/SK55 SRX	Pin-on	-E2051	120
Kobelco	SK 35SR-5/SK 30SR-3/SK 30SR-5/SK 35SR-3	Pin-on	-E3354	120
Kobelco	SK85/SK85CSS-3E/K 903 MKII/80 CS/K03/SK 60 MK III/SK80CS-3/ SK85CS	Pin-on	-E2070	120
Komatsu	PC78/PC95/PC88US-8/PC88US-10/PC88MR-8/PC88MR-6/PC88MR-3/ PC88MR-11/PC88MR-10/PC88/PC80/PC78US-8/PC78US-6/PC78US-11/ PC78U-10/PC78MR-6/PC78 US-6/PC78/PC75UU/PC70-8/PC660-7B/PC60- 7/PC60-6/PC60-5/PC60-4/PC60-3/PC60-2/PC60	Pin-on	-E0060	120
Kubota	K7770/K7870 coupler/KX040-4/KX018-4/KX-121-3/KX41-3/KX71-3/KX91-3/ L39/L45/L48/M59/U15/U17/U25S/U35/U35S	Coupler	-E1091	120
Kubota	KX121/KH91/KH121/KH90/KH91/KX033-4/KX040-4/KX101/KX121-2/KX121-3/ KX1213S/KX121SR-2/KX71-3/KX71-3S/KX91/KX91-2/KX91-3/U35/U35 R1/ U35-4	Pin-on	-E0091	120
Kubota	K7915 coupler/U55-4/KX057-4	Coupler	-E5057	120
Kubota	KX161/U55-4/U45/KX161-3S/KX161-3/KX161-2SR2/KX161-2/KX151/KH161/ KH151/KH040/K161	Pin-on	-E0151	120
Kubota	K7880 coupler/KX040-4/KX161-3	Coupler	-E1151	120
Kubota	KX057-4/KX057-5	Pin-on	-E5055	120
Kubota	KX057 CANADA	Coupler	-E5056	120
Kubota	KX080-3	Pin-on	-E3080	120
Kubota	K7402 coupler/KX080-4/KX080-3	Coupler	-E4080	120
Kubota	K7402 HEAVY MOUNT/KX080-4/KX080-3	Coupler	-E4080HM	120
Mitsubishi	MS70	Pin-on		120
Mustang	3503/3503B/3003/3703	Pin-on	-E0223	120
Mustang	5003/5003ZT	Pin-on	-E0503	120
Mustang	550Z/450Z	Pin-on	-E0050	120
Mustang	800Z	Pin-on	-E1171	120
New Holland	EH50.B/E55BX/E50B	Pin-on	-E2051	120
New Holland	E37C/E33C	Pin-on	-E0535	120
New Holland	E60C/E57C	Pin-on	-E1060	120
New Holland	EH35.B/EH30/E30B/E35B	Pin-on	-E3354	120

FLAIL MOWER EXCAVATOR MOUNTS CONTINUED NEXT PAGE

# FLAIL MOWERS

## FLAIL MOWERS FOR EXCAVATORS CONT.

FLAIL MOWERS

EXCAVATOR MOUNTS (ONE REQUIRED - CONTACT FACTORY FOR MOUNTS NOT LISTED)				
MAKE	MODELS	PIN-ON / COUPLER	SUFFIX CODE	SHIP WEIGHT (LBS)
New Holland	EH800	Pin-on	-E2070	120
Sany	SY60C	Pin-on	-E6060	120
Schaeff	ZX-75	Pin-on	-E0442	120
Steelwrist	S50 COUPLER	Coupler	-E9950	120
Takeuchi	53/TB045/TB145/53FR/TB153FR/TB250/TB53FR	Pin-on	-E0045	120
Takeuchi	TB240/TB035/TB135/TB138FR/TB235	Pin-on	-E0135	120
Takeuchi	TB260	Pin-on	-E2260	120
Takeuchi	TB175/TB070/TB180/TB180FR/TB285/TB290	Pin-on	-E0071	120
Terex	HR32	Pin-on	-E0442	120
Volvo	EC88/ECR88	Pin-on	-E0088	120
Volvo	EC55	Pin-on	-E2055	120
Wacker Neuson	28Z3/EZ26/3703/38Z3/3003/EZ28/3503/EZ38/EZ36	Pin-on	-E0223	120
Wacker Neuson	EZ53/6503/50Z3/6003	Pin-on	-E0503	120
Wacker Neuson	EW65/ET65	Pin-on	-E0565	120
Wacker Neuson	ET90	Pin-on	-E3090	120
Werk-Brau	KLAC-E		-E3355	120
Yanmar	VIO45/VO40/ViO55-5/B 6/ViO45-5/ViO50-2/VO50/B 5/ViO40-2/B50-2B	Pin-on	-E0050	120
Yanmar	ViO-80/B7 SIGMA/B7-3/SV100/ViO-70/ViO-75/VO75/Z80	Pin-on	-E1171	120
	NO MOUNT	NO MOUNT	-EBLNK	

REPLACEMENT PARTS			
	ORDER CODE	SHIP WEIGHT (LBS)	LIST PRICE
Blade set for 30" flail mower (includes 16 curved and 8 straight blades)	28-10821	50	\$968
Blade set for 40" flail mower (includes 20 curved and 10 straight blades)	28-10822	60	\$1,053
Flail Blade Curved - Individual	07-8235		\$34
Flail Blade Strait - Individual	07-8236		\$80
Bolt and nut kit for flail mower (includes 2 bolts and 2 slotted nuts)	28-10823	5	\$144
Roll pin kit for flail mower (includes 2 roll pins)	28-10824	1	\$51
Deflector kit for 30" flail mower (includes 1 deflector and hardware)	28-10827	10	\$89
Deflector kit for 40" flail mower (includes 1 deflector and hardware)	28-10828	10	\$150
Skid shoe kit (includes 1 skid shoe and hardware)	28-10826	15	\$359
Bearing kit (includes 1 bearing and hardware)	28-10825	15	\$438
Torsion disc kit (includes 1 torsion disc and hardware)	28-10829	15	\$1,704

# FORKS & CARRIAGES



# FORKS & CARRIAGES

## CAR FORK CARRIAGES

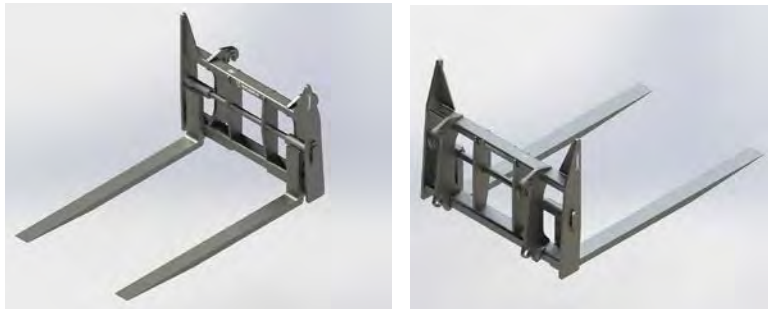

- 5,000 to 21,000 pound capacities
- Full floating pin design
- "Bat ear" load back rest allows for open center for improved visibility

## CAR FORK CARRIAGES FOR TRACTOR LOADERS/BACKHOES AND WHEEL LOADERS



**NOTE: CAR FORK & FRAMES FEATURE A SINGLE FORK SHAFT GOING FULL WIDTH OF THE CARRIAGE WITH SHAFT SUPPORT PLATE IN THE CENTER FOR ADDED STRENGTH. THIS SUPPORT ALSO TIES IN THE LOWER AND UPPER CROSS TUBES IN THE CENTER. ADDITIONALLY, WE FEATURE A RETAINER DEVICE ON THE LOWER SIDE OF THE CARRIAGE TO HOLD THE FORK TIPS RIGID THEREBY ALLOWING FOR EASY CRUSHING OF THE CAR TOP. "BAT EAR" STYLE LOAD BACK REST ALLOWS FOR OPEN CENTER LOAD BACK REST FOR OPTIMAL VISIBILITY. TOP CHISEL TAPER IS STANDARD ON ALL CAR FORKS.**

CAR FORK CARRIAGES (FRAME & FORKS)	ORDER CODE	SHIP WEIGHT (LBS)	LIST PRICE
<b>60" wide with 2.5" x 6" x 84" top chisel forks (21,000 lb cap)</b>			
<b>21,000 lb. cap, 2.25" shaft - uses 2.5" x 6" wide forks</b>			
JCB 411/416/426/436 w/HT coupler "Bat Ear style back rest"	12614	1660	POR
JCB 416 5 x 6 84" forks	12672	1660	POR
John Deere 444C pin mount	12507	675	POR
New Holland LW130-170 w/ quick coupler	12614	1660	POR
Volvo L70-L120 w/quick coupler	12614	1660	POR
<b>60" wide with 2.5" x 6" x 84" bottom chisel forks (21,000 lb cap)</b>			
JCB 411 / 416 / 426 / 436 with quick coupler	12824	1600	\$8,932
New Holland LW130-170W with quick coupler	12824	1600	\$8,932
Volvo L30-120 with quick coupler	12824	1600	\$8,932

## PALLET FORK FRAME



- Heavy-duty frame designed to handle 4,000 lb. to 6,200 lb. fork capacities
- Brick guard offers strength & smooth surfaces for protection against load damage
- Patented design offers excellent visibility & includes load securing "D" ring
- 42", 48", 60" and 72" tines available
- Personalized logo burned into brick guard available on standard model
- Standard, Extended, Walk-Thru available
- NEW Walk-Thru carriage design has an open frame for easy, safe access to operator compartment on loader

Specifications	Overall Height	Overall Width	Max Tine Spacing	Min Tine Spacing	ITA Category II Fork Mounting
standard width	39"	55"	43"	12"	16"
extended width	39"	65"	59"	13"	16"
walk-thru	38"	50.5"	43"	12"	16"

## PALLET FORK FRAMES - CLASS II ITA FOR SKID-STEER LOADERS



Tines Sold Separately      A (5500 LB Capacity)

STANDARD AND WALK-THRU PALLET FORK FRAME - CLASS II ITA	ORDER CODE	SHIP WEIGHT (LBS)	LIST PRICE
45" Signature Series Standard pallet fork frame (left or right hand bolt on step)	30945-0022	270	\$690
45" Bradco Signature Series (2") Drop Height Pallet Frame (left or right hand bolt on step)	30946-0022	270	\$776
45" Standard walk-thru single step pallet fork frame (left or right hand bolt on step)	30947-0022	260	\$649
45" Standard walk-thru (2" drop) pallet fork frame (left or right hand bolt on step)	30948-0022	260	\$729
45" Standard walk-thru single step pallet fork frame (left or right hand bolt on step), custom logo	30951-0022	260	\$750
60" universal (2") Drop Tine Height	119401	265	\$905

PALLET FORK TINES	ORDER CODE	SHIP WEIGHT (LBS)	LIST PRICE
<b>Standard Pallet Fork Tines (pair)</b>			
42" tines (4,000 lb.)	66302	168	\$461
48" tines (4,000 lb.)	67604	186	\$481
<b>Heavy-Duty Pallet Fork Tines (pair)</b>			
42" tines (6,000 lb.)	85962	225	\$1,107
48" tines (6,000 lb.)	85994	250	\$657
60" tines (6,200 lb.)	12678	300	\$824
72" tines (6,200 lb.)	12509	380	\$955

PALLET FORK FRAMES CONTINUED NEXT PAGE

# FORKS & CARRIAGES

## PALLET FORK FRAME CONT.

### PALLET FORK FRAME - CLASS II ITA FOR SKID-STEER LOADERS CONT.

PALLET FORK TINES CONT.		ORDER CODE	SHIP WEIGHT (LBS)	LIST PRICE
<b>Value Fork Tines (pair)</b>				
42" tines (3,750 lb.)		102028	218	\$409
48" tines (3,750 lb.)		102030	250	\$425
42" tines (5,500 lb.)		102032	260	\$828
48" tines (5,500 lb.)		102034	270	\$499
<b>Block Tines</b>				
1.5 x 2 x 48" set of 6 ITA class II		11995	349	\$2,567
2" x 2" x 48" set of 4		32984	353	\$2,225

OPTIONS		ORDER CODE	SHIP WEIGHT (LBS)	LIST PRICE
<b>Bale Spike Assembly (must order pallet fork frame)</b>				
2-spear, ITA mount		17253	56	\$778
3-spear, ITA mount		17240	81	\$989
<b>Tow Hitch Assembly</b>				
optional tow hitch		100899	37	\$559
<b>Assembly Charge (assemble tines to pallet fork frame at factory)</b>				
net cost per each unit assembled			contact factory	

### PALLET FORK FRAME - CLASS II ITA FOR COMPACT TRACTORS



PALLET FORK (ITA PALLET FORK WITH UNIVERSAL SKID-STEER COUPLER HITCH)		ORDER CODE	SHIP WEIGHT (LBS)	LIST PRICE
pallet fork assembly with 42" tines		108308	252	\$973
pallet fork assembly with 48" tines		108309	283	\$996

OPTIONS		ORDER CODE	SHIP WEIGHT (LBS)	LIST PRICE
Auger mount assembly ITA Class II		17253	56	POR
3-spear, ITA mount bale spike assembly - must order pallet fork frame		17240	81	POR
<b>Tow Hitch Assembly</b>				
optional tow hitch		100899	37	\$559

### PALLET FORK FRAME - CLASS II ITA FOR EURO/GLOBAL MOUNTS



STANDARD PALLET FORK FRAME - CLASS II ITA		ORDER CODE	SHIP WEIGHT (LBS)	LIST PRICE
Euro / Global mount 48" wide		109065	237	\$1,015
Euro / Global mount 60" wide		115890	195	\$1,065

PALLET FORK TINES		ORDER CODE	SHIP WEIGHT (LBS)	LIST PRICE
<b>Standard Pallet Fork Tines (pair)</b>				
42" tines (4,000 lb.)		66302	168	\$461
48" tines (4,000 lb.)		67604	186	\$481

PALLET FORK TINES CONTINUED NEXT PAGE

## PALLET FORK FRAME CONT.

### PALLET FORK FRAME - CLASS II ITA FOR EURO/GLOBAL MOUNTS CONT.

PALLET FORK TINES CONT.		ORDER CODE	SHIP WEIGHT (LBS)	LIST PRICE
<b>Heavy-Duty Pallet Fork Tines (pair)</b>				
42" tines (6,000 lb.)		85962	225	\$1,107
48" tines (6,000 lb.)		85994	250	\$657
60" tines (6,200 lb.)		12678	300	\$824
72" tines (6,200 lb.)		12509	380	\$955
<b>Value Fork Tines (pair)</b>				
42" tines (3,750 lb.)		102028	218	\$409
48" tines (3,750 lb.)		102030	250	\$425
42" tines (5,500 lb.)		102032	260	\$490
48" tines (5,500 lb.)		102034	270	\$499
<b>Block Tines</b>				
1.5 x 2 x 48" set of 6 ITA class II		11995	349	\$2,567
2" x 2" x 48" set of 4		32984	353	\$2,225

OPTIONS		ORDER CODE	SHIP WEIGHT (LBS)	LIST PRICE
<b>Bale Spike Assembly (must order pallet fork frame)</b>				
2-spear, ITA mount		17253	56	POR
3-spear, ITA mount		17240	81	POR
<b>Tow Hitch Assembly</b>				
optional tow hitch		100899	37	\$559
<b>Assembly Charge (assemble tines to pallet fork frame at factory)</b>				
net cost per each unit assembled		contact factory		

### PALLET FORK FRAME - CLASS II ITA FOR TRACTOR LOADERS



STANDARD PALLET FORK FRAME - CLASS II ITA		ORDER CODE	SHIP WEIGHT (LBS)	LIST PRICE
John Deere 400/500 tractor loader		15540	188	\$1,078
John Deere 600/700 tractor loader		18010	249	\$690
PALLET FORK TINES		ORDER CODE	SHIP WEIGHT (LBS)	LIST PRICE
<b>Standard Pallet Fork Tines (pair)</b>				
42" tines (4,000 lb.)		66302	168	\$461
48" tines (4,000 lb.)		67604	186	\$481
<b>Heavy-Duty Pallet Fork Tines (pair)</b>				
42" tines (6,000 lb.)		85962	225	\$1,107
48" tines (6,000 lb.)		85994	250	\$657
60" tines (6,200 lb.)		12678	300	\$824
72" tines (6,200 lb.)		12509	380	\$955

PALLET FORK TINES CONTINUED NEXT PAGE

# FORKS & CARRIAGES

## PALLET FORK FRAME CONT.

### PALLET FORK FRAME - CLASS II ITA FOR TRACTOR LOADERS CONT.

PALLET FORK TINES CONT.		ORDER CODE	SHIP WEIGHT (LBS)	LIST PRICE
<b>Value Fork Tines (pair)</b>				
42" tines (3,750 lb.)		102028	218	\$409
48" tines (3,750 lb.)		102030	250	\$425
42" tines (5,500 lb.)		102032	260	\$490
48" tines (5,500 lb.)		102034	270	\$499
<b>Block Tines</b>				
1.5 x 2 x 48" set of 6 ITA class II		11995	349	\$2,567
2" x 2" x 48" set of 4		32984	353	\$2,225

OPTIONS		ORDER CODE	SHIP WEIGHT (LBS)	LIST PRICE
<b>Bale Spike Assembly (must order pallet fork frame)</b>				
2-spear, ITA mount		17253	56	POR
3-spear, ITA mount		17240	81	POR
<b>Tow Hitch Assembly</b>				
optional tow hitch		100899	37	\$559
<b>Assembly Charge (assemble tines to pallet fork frame at factory)</b>				
net cost per each unit assembled		contact factory		

Add Surcharge to all products 8.85%

## PALLET RAIL STYLE FORK

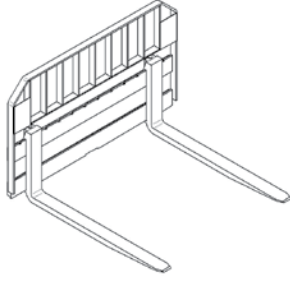

- Heavy duty, Class III pallet fork frame for wheel loaders, backhoes and telehandlers with lift capacities of up to 10,000 lbs
- Back frames available in 48", 60", and 72" widths
- Tines available in 42", 48", and 60" lengths for a variety of applications

Carrier Specifications	
Lift Capacity	Operating Weight
<10,000 lbs	<32,000 lbs
<10,000 lbs	<32,000 lbs
<10,000 lbs	<32,000 lbs

Specifications - Class III Fork Carriages						
Model #	Weight (approx)	Max. Lift Cap.	Width OD	Fits	Tine Length	
10022	460 lbs	10,000 lbs	48"	Wheel & Backhoe Loaders	NA	
10047	600 lbs	10,000 lbs	60"	Wheel & Backhoe Loaders	NA	
10021	750 lbs	10,000 lbs	72"	Wheel & Backhoe Loaders	NA	

Specifications - Kits for Class III Forks*			
Model #	Weight (Approx.)	Depth OD	Fork Size
10043	256 lbs	45.625"	2x5x42"
10044	320 lbs	51.625"	2x5x48"
10045	399 lbs	63.625"	2x5x60"

**Check capacity and limits of loader before ordering.**

*\*Includes set of 2 forks, only required if purchasing Class III Forks*

**INCLUDES: PALLET RAIL STYLE FORK. TO ORDER :CHOOSE FORK, MOUNTING AND KIT FOR CLASS III FORKS.**  
**NOTE: SHIPPING WEIGHTS VARY DEPENDING ON LOADER MOUNTING AND PACKAGING.**

## CLASS III RAILSTYLE PALLET FOR WHEEL LOADERS AND BACKHOE LOADERS



PALLET FORKS			
CHECK LOADER CAPACITY BEFORE ORDERING			
	ORDER CODE	SHIP WEIGHT (LBS)	LIST PRICE
Does NOT Include Tines			
48" OD Class III Railstyle Pallet Forks w/out forks	10022	460	POR
60" OD Class III Railstyle Pallet Forks w/out forks	10047	600	POR
72" OD Class III Railstyle Pallet Forks w/out forks	10021	1010	POR

MOUNTING - ADDITIONAL COST MAY APPLY		ORDER CODE	SHIP WEIGHT (LBS)
Contact Customer Service at (833) 723-1843			

KIT FOR CLASS III FORKS - INCLUDES SET OF 2 FORKS (ONLY REQUIRED IF PURCHASING CLASS III FORKS)			
	ORDER CODE	SHIP WEIGHT (LBS)	LIST PRICE
2x5x42" Class III Fork Kit	FFC10043	256	\$1,232
2x5x48" Class III Fork Kit	FFC10044	320	\$1,359
2x5x60" Class III Fork Kit	FFC10045	399	\$1,573

# FORKS & CARRIAGES

## FLOATING PIN CARRIAGES



- 48" to 84" widths available
- Full floating pin design

### FLOATING PIN CARRIAGES FOR TRACTOR LOADERS/BACKHOES

	ORDER CODE	SHIP WEIGHT (LBS)	LIST PRICE
<b>48"</b>			
blank-no mounts 10,000 lb cap, 2.25" shaft	12357	520	\$3,275
Cat IT/TH 10,000 lb cap 60mm shaft	11715	500	\$3,680
<b>66"</b>			
Cat IT/TH 10,000 lb cap 60mm shaft	11435	825	\$728
JCB Q-fit 10,000 lb cap 2.25" shaft	11428	490	\$153
<b>74"</b>			
Cat IT/TH 10,000 lb cap 60mm shaft	11714	583	\$5,018
JCB Q-fit 10,000 cap 2.25" shaft	11504	975	\$5,018



### FLOATING PIN CARRIAGES FOR WHEEL LOADERS

	ORDER CODE	SHIP WEIGHT (LBS)	LIST PRICE
<b>48"</b>			
blank-no mounts 10,000 lb cap, 2.25" shaft	12357	520	\$3,275
Cat 902/906/908 10,000 lb cap 60mm shaft	12569	520	\$3,680
Cat IT/TH 10,000 lb cap 60mm shaft	11715	500	\$3,680
<b>60"</b>			
Cat IT/TH 10,000 lb cap 60mm shaft	11435	825	\$728
JCB 411,416,426,436 w/ HT coupler uses 2.5" x 6" wide forks	12341	600	\$3,645
JCB 411/416/426/436 with HT coupler (21,000 lb cap 2.25" shaft uses 2.5x6" wide forks)	12371	670	\$242
JCB 411-416 5 x 6 x 72" forks (forks included)	12824	1600	\$8,932
JCB 416 5 x 6 x 48" forks (forks included)	12614	1660	\$8,932
JCB 416 5 x 6 84" forks (forks included)	12672	1660	\$8,932
John Deere 444C pin mount	12507	675	\$8,932
JRB 416 hitch 21,400# rated	12897	735	\$2,954
New Holland LW130-170 w/ quick coupler uses 2.5" x 6" wide	12341	600	\$3,645
Volvo L70-L120 w/quick coupler uses 2.5" x 6" wide forks	12341	600	\$3,645
<b>74"</b>			
Cat IT/TH 10,000 lb cap 60mm shaft	11714	583	\$5,018
<b>84"</b>			
JCB 411,416,426,436 w/ HT coupler "Bat Ear style back rest"	12377	890	\$5,890
New Holland LW130-170 w/ quick coupler	12377	890	\$5,890
Volvo L70-L120 w/quick coupler	12377	890	\$5,890



## PALLET FORK FRAME - SHAFT



- Standard brick guard
- Adjustable tines
- Utilizes shaft styles 1.38 x 4.75 x 42" or 48"
- 42" and 48" fork tines lengths available

## PALLET FORK FRAME - SHAFT FOR COMPACT TRACTORS



	ORDER CODE	SHIP WEIGHT (LBS)	LIST PRICE
42" forks, shaft style pallet fork	10703-42-0822	335	\$1,290
48" forks, shaft style pallet fork	10703-48-0822	355	\$1,333

## FORK POSITIONERS - SIDE SHIFT



- 4" left and right shift for 8" overall movement
- 48", 60", 66", & 74" widths available
- 5,000 lb to 12,000 lb capacities
- Floating pin & ITA configurations

## SIDE SHIFT CARRIAGES FOR SKID STEER LOADERS



	ORDER CODE	SHIP WEIGHT (LBS)	LIST PRICE
<b>48"</b>			
SSL Universal Hitch 2-1/4" shaft	13441	806	\$6,106

## SIDE SHIFT CARRIAGES FOR TRACTOR LOADERS/BACKHOES



	ORDER CODE	SHIP WEIGHT (LBS)	LIST PRICE
<b>48"</b>			
Cat IT/TH 10,000 lb cap 60mm	11324	745	\$7,827
JCB 10,000 lb cap ITA class III	12659	1005	\$7,827
JCB & New Holland 10,000 lb cap 2 1/4" shaft	12633	745	\$7,827
<b>74"</b>			
Cat IT/TH 10,000 lb cap 60mm shaft	11510	800	\$8,505

## SIDE SHIFT CARRIAGES FOR WHEEL LOADERS



	ORDER CODE	SHIP WEIGHT (LBS)	LIST PRICE
<b>48"</b>			
Cat IT/TH 10,000 lb cap 60mm shaft	11324	745	POR
<b>74"</b>			
Cat IT/TH 10,000 lb cap 60mm shaft	11510	800	POR

# FORKS & CARRIAGES

## FORK POSITIONERS - SIDE TILT WITH FLOATING PIN

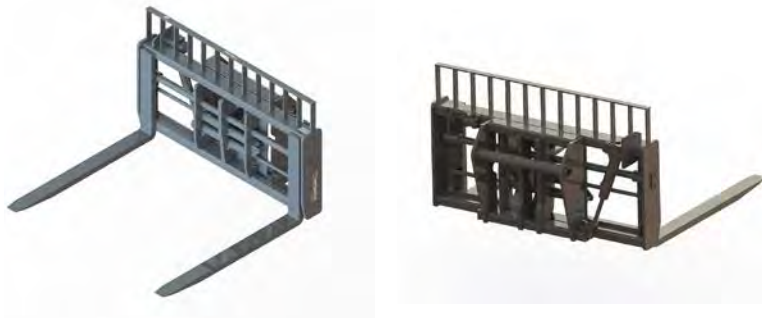

- 10° left and right tilt, min. 20° overall minimal tilt
- 48", 60", 66", & 72" widths available
- 5,000 lb to 12,000 lb capacities
- Counter balance cylinders hold carriage in position upon a loss of pressure

### SIDE TILT CARRIAGES FOR TRACTOR LOADERS/BACKHOES



	ORDER CODE	SHIP WEIGHT (LBS)	LIST PRICE
<b>48"</b>			
Cat IT/TH 10,000 lb cap 60mm shaft	11294	900	\$7,780
<b>72"</b>			
Cat IT/TH 10,000 lb cap 60mm shaft	11709	780	\$7,827

### SIDE TILT CARRIAGES FOR WHEEL LOADERS



	ORDER CODE	SHIP WEIGHT (LBS)	LIST PRICE
<b>48"</b>			
Cat IT/TH 10,000 lb cap 60mm shaft	11294	900	\$7,780
<b>72"</b>			
Cat IT/TH 10,000 lb cap 60mm shaft	11709	780	\$7,827

Add Surcharge to all products 85%

## FORK POSITIONERS WITH FORKS

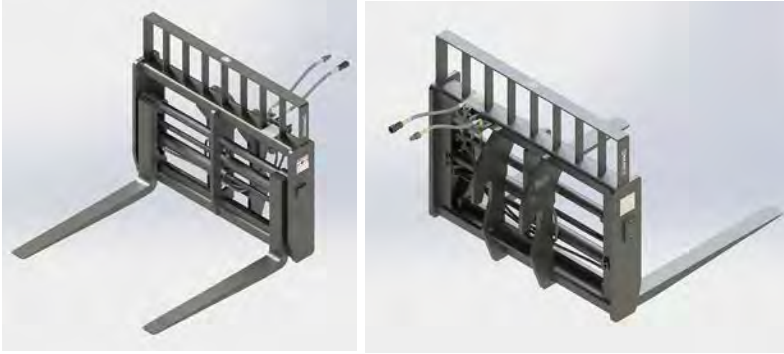

- 48", 60", 72", & 78" widths available
- 5,000 to 10,000 lb capacity
- Forks are hydraulically operated to move apart or together for accurate & fast positioning in pallets
- Optional side shift version available

## FORK POSITIONERS WITH FORKS FOR TRACTOR LOADERS/BACKHOES



	ORDER CODE	SHIP WEIGHT (LBS)	LIST PRICE
<b>48" Fork Positioner with Forks</b>			
Cat IT 2 x 5 x 60" forks 10,000 lb cap 2.25" shaft Cat 416C IT, 420D IT	12444	1166	\$11,372
Cat IT only 2 x 5 x 48" forks 10,000 lb cap 2.25" shaft Cat 416C IT, 420D IT	11311	1025	\$11,051
Cat IT 2x5x72" forks 10,000 lb cap 2.25" shaft Cat 416C IT, 420D IT, 430D IT only	12634	1266	\$11,813
JCB 210S/212S 2 x 5 x 48" forks 10,000 lb cap 2.25" shaft	12474	1153	\$11,051
JCB Q-fit 2 x 5 x 48" forks 10,000 lb cap 2.25" shaft JCB Q-Fit 214 / 215 / 217	12407	1020	\$6,753
JRB HV100 2 x 5 x 48" forks	12669	1136	POR
<b>48" Side-Shift Fork Positioner with Forks</b>			
Cat IT/TH 2 x 5 x 48" forks 10,000 lb cap 2.25" shaft Cat 416C IT, 420D IT, 430D IT	11329	1025	\$13,911
<b>72" Fork Positioner with Forks</b>			
Cat IT/TH 2 x 5 x 48" forks 10,000 lb cap 2.25" shaft Cat 416C IT, 420D IT, 430D IT	11474	1285	\$8,218
Cat IT 2 x 5 x 48" forks 10,000 lb cap 2.25" shaft Cat 416C IT, 420D IT, 430D IT	12588	1285	\$11,386
FFC QCP 7000 w/2 x 5 x 60" forks 10,000 lb cap 2.25" pin	13208	1505	\$11,386
JCB Q-fit 2 x 5 x 72" forks	12623	1431	\$12,342
FORK POSITIONERS WITH FORKS CONTINUED NEXT PAGE			

Add Surcharge to all products 8.25%

# FORKS & CARRIAGES

## FORK POSITIONERS WITH FORKS CONT.



### FORK POSITIONERS WITH FORKS FOR WHEEL LOADERS

	ORDER CODE	SHIP WEIGHT (LBS)	LIST PRICE
<b>48" Fork Positioner with Forks</b>			
Cat IT14, IT24 only 2 x 5 x 60" forks 10,000 lb cap 2.25" shaft	12444	1166	\$11,372
Cat IT 14 only 2 x 5 x 72" forks 10,000 lb cap 2.25" shaft	12634	1266	\$11,813
Cat IT only 2 x 5 x 48" forks 10,000 lb cap 2.25" shaft	11311	1025	\$11,051
JRB HV100 2 x 5 x 48" forks	12669	1136	POR
New Holland LW50B 2 x 4 x 48" forks 8,000 lb cap 2¼" shaft	12446	963	\$11,051
<b>72" Fork Positioner with Forks</b>			
Cat IT14, IT24 only 2 x 5 x 48" forks 10,000 lb cap 2.25" shaft	12588	1285	POR
JCB 400 Series 2 x 5 x 72" forks	12870	1425	\$11,310
JCB 411, 416, 426, 436 2 x 5 x 48" forks 10,000 lb cap	12769	1340	\$11,105
JCB 416HT 2.50 x 6.00 x 48" forks	12983	1620	\$11,310
New Holland LW130-170 2x5x48" forks 10,000 lb cap	12769	1340	\$11,105
Volvo L70-L120 2x5x48" forks 10,000 lb cap	12769	1340	\$11,105
<b>72" Side-Shift Fork Positioner with Forks (10,000 lb. cap)</b>			
Cat IT/TH 2 x 5 x 48 forks	12930	1470	\$11,310
Cat IT14, IT24 hitch only 2 x 5 x 60" forks	11489	1470	\$11,310
<b>72" Side-Tilt Fork Positioner with Forks (10,000 lb. cap)</b>			
Cat IT14, IT24 hitch only 2 x 5 x 72" forks	12448	1960	\$11,310

Add Surcharge to all products 8.25%

## FORKS - BLOCK TINES



- Typically used for handling pallets of brick and block



**8,000 lb. capacity requires four (4) 2" x 2" tines**  
**10,000 lb. capacity requires six (6) 2" x 2" tines**

## FORKS - BLOCK TINES FOR TRACTOR LOADERS/BACKHOES AND WHEEL LOADERS



	ORDER CODE	SHIP WEIGHT (LBS)	LIST PRICE
1.5 x 2 x 48" set of 6 ITA class II	11995	349	\$2,567
1.5 x 2 x 48" set of 6 JCB 1.75" pin	12431	500	\$2,915
2 x 1.5 x 48" set of 6 JCB 2" pin dia	12482	450	\$2,353

Add Surcharge to all products 8.85%

# FORKS & CARRIAGES

## FORKS - FLOATING PIN

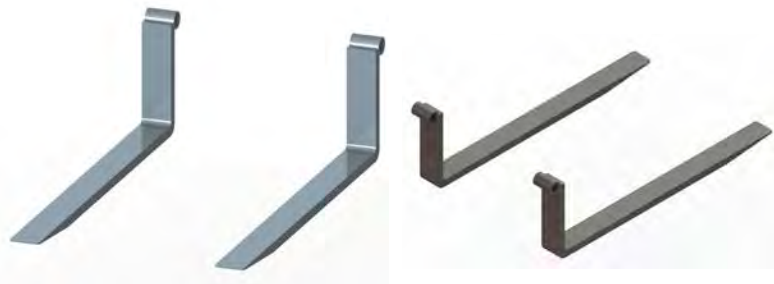

- 2,300 to 21,000 lb capacities
- Shaft mount & ITA configuration fork styles available
- Cubing or block tines, brick forks, standard chisel low back & high back styles and negative drop forks

### FORKS - FLOATING PIN FOR TRACTOR LOADER/BACKHOES



6,860 LB. LOAD-RATED FORKS (PAIR)	ORDER CODE	SHIP WEIGHT (LBS)	LIST PRICE
1.75 x 4 x .48" pair Cat 60mm	12765	280	\$2,291
1.75 x 4 x 48" pair JCB 2" pin	12367	280	\$1,909
1.75 x 4 x 60" pair JCB 520/523, 1.75" shaft	12309	280	\$2,160
1.75 x 4 x 84" pair JCB 520, 1.75" shaft	12411	280	\$1,179
1.75 x 4 x 84" pair SkyTrak 2" shaft	12483	280	\$2,947

10,000 LB. LOAD-RATED FORKS (PAIR)	ORDER CODE	SHIP WEIGHT (LBS)	LIST PRICE
2 x 5 x 48" pair Cat 60mm pin dia	12253	380	\$1,413
2 x 5 x 48" pair JCB 2.25" pin dia	12014	380	\$965
2 x 5 x 48" pair Manitou 2" pin dia	12516	350	\$802
2 x 5 x 48" pair New Holland 2.25" pin dia	12014	380	\$965
2 x 5 x 48" pair SkyTrak 2" pin dia	12516	350	\$802
2 x 5 x 48" pair Volvo 2" pin dia	12516	350	\$802
2 x 5 x 60" pair Cat 60mm pin dia	12020	460	\$995
2 x 5 x 60" pair JCB/NH 2.25 pin dia	14644	460	\$2,219
2 x 5 x 60" pair New Holland 2.25 pin dia	14644	460	\$2,219
2 x 5 x 72" pair Cat 60mm pin dia	12255	550	\$964
2 x 5 x 72" pair JCB 2.25" pin dia	12023	550	\$1,392
2 x 5 x 72" pair New Holland 2.25" pin dia	12023	550	\$1,392
2 x 5 x 72" pair JCB 2" pin dia	12480	550	\$2,696
2 x 5 x 72" pair Lull 844	12524	550	\$891

FLOATING PIN FORKS CONTINUED NEXT PAGE

## FORKS - FLOATING PIN CONT.

### FORKS - FLOATING PIN FOR TRACTOR LOADERS/BACKHOES CONT.

12,640 LB. LOAD-RATED FORKS (PAIR)	ORDER CODE	SHIP WEIGHT (LBS)	LIST PRICE
2 x 6 x 60" pair Gehl 2.50" pin dia	11838	570	\$2,556
2 x 6 x 72" pair Gehl 2.50" pin dia	11840	650	POR

### FORKS - FLOATING PIN FOR WHEEL LOADERS



6,860 LB. LOAD-RATED FORKS (PAIR)	ORDER CODE	SHIP WEIGHT (LBS)	LIST PRICE
1.75 x 4 x 48" pair JCB 2" pin	12367	280	\$1,909
1.75 x 4 x 60" pair JCB 520/523, 1.75" shaft	12309	280	\$2,160
1.75 x 4 x 84" pair JCB 520, 1.75" shaft	12411	280	POR
1.75 x 4 x 84" pair SkyTrak, 2" shaft	12483	280	\$2,947

8,000 LB. LOAD-RATED FORKS (PAIR)	ORDER CODE	SHIP WEIGHT (LBS)	LIST PRICE
2 x 4 x 48" pair Cat 60mm pin dia	12252	340	\$878
2 x 4 x 48" pair Gehl 2" pin dia	12415	340	\$1,191
2 x 4 x 48" pair JCB 2.25" pin dia	12006	340	\$1,909
2 x 4 x 48" pair JCB 2" pin	12275	340	\$1,159
2 x 4 x 48" pair Lull 844B	12584	340	\$1,953
2 x 4 x 48" pair New Holland 2.25" pin dia	12006	340	POR
2 x 4 x 60" pair JCB 2.25" pin dia	12009	350	\$2,088
2 x 4 x 60" pair JCB 2" pin dia	12413	350	\$1,636
2 x 4 x 60" pair New Holland 2.25" pin dia	12009	350	\$2,088
2 x 4 x 60" pair SkyTrak	12458	375	\$1,770

10,000 LB. LOAD-RATED FORKS (PAIR)	ORDER CODE	SHIP WEIGHT (LBS)	LIST PRICE
2 x 5 x 48" pair Volvo 2" pin dia	12516	380	\$802
2 x 5 x 60" pair Cat 60mm pin dia	12020	460	\$995
2 x 5 x 60" pair JCB 2.25 pin dia	14644	460	\$2,219
2 x 5 x 60" pair New Holland 2.25 pin dia	14644	460	\$2,219
2 x 5 x 72" pair Cat 60mm pin dia	12255	550	\$964
2 x 5 x 72" pair JCB/NH 2.25" pin dia	12023	550	\$1,392
2 x 5 x 72" pair JCB 2" pin dia	12480	550	\$2,696
2 x 5 x 72" pair Lull 844	12524	550	POR

21,400 LB. LOAD-RATED FORKS (PAIR)	ORDER CODE	SHIP WEIGHT (LBS)	LIST PRICE
2.5 x 6 x 84" pair low back 2.25" pin dia	12593	1050	\$5,508

# FORKS & CARRIAGES

## HOOK ON FORKS

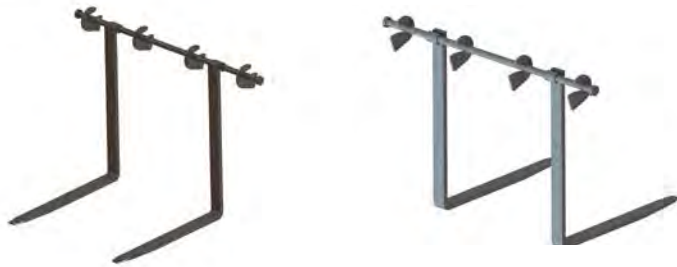

- Includes 2 forks - 1.5" x 4" x 48"
- 48" back height
- 72" fork shaft and 4 mounting lugs weld onto your bucket

## HOOK ON FORKS FOR TRACTOR LOADERS/BACKHOES



	ORDER CODE	SHIP WEIGHT (LBS)	LIST PRICE
1.5 x 4 x 48" set 72" wide 5,400 lb cap	12519	390	\$2,253

## ITA TINES



- Class I, II, III, and IV
- Sizes range from 48" to 96" depending on class

## ITA FOR TRACTOR LOADERS/BACKHOES AND WHEEL LOADERS



	ORDER CODE	SHIP WEIGHT (LBS)	LIST PRICE
60" tines (6,200 lb.)	12678	300	\$824
72" tines (6,200 lb)	12509	380	\$955
<b>Class III</b>			
2 x 4 x 48" pair class III 8,000 lb cap	12452	364	\$1,909
2 x 4 x 60" pair class III 8,000 lb cap	12453	416	\$1,481
2 x 5 x 60" pair class III 10,000 lb cap	12660	460	\$2,200
2 x 5 x 72" pair class III 10,000 lb cap	12268	536	\$2,651

# GRAPPLES



# GRAPPLES

## SHARKBITE™ GRAPPLE



- Fits all standard Class II ITA fork rails
- Field install is under 5 minutes with no tools
- High strength steel construction
- Powder coat finish
- Shark teeth and Forks sold separately

### FORK-STYLE INSTALL

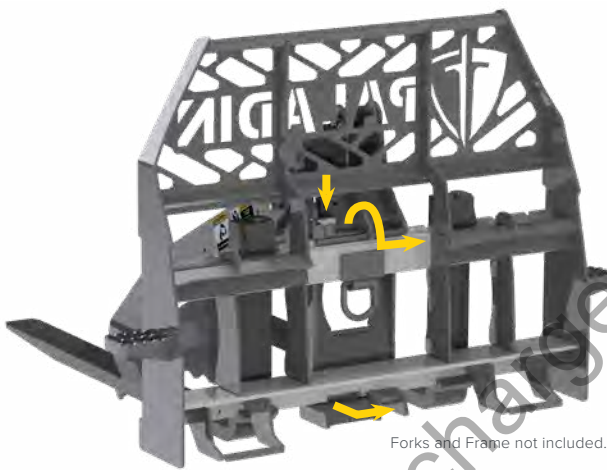

MINIMUM LOAD DIAMETER	OVERALL HEIGHT	DEPTH	MINIMUM ENVELOPE	PASS-THRU	RANGE OF MOTION
14"	63.5"	46.5"	7.5"	7.5"	117°

### SHARKBITE GRAPPLE™ FOR SKID-STEER LOADERS



SHARKBITE™ GRAPPLE (HOSES INCLUDED)	ORDER CODE	SHIP WEIGHT (LBS)	LIST PRICE
Sharkbite Grapple	233180	175	\$1,785

OPTIONS	ORDER CODE	SHIP WEIGHT (LBS)	LIST PRICE
Reversible AR400 hardened teeth (QTY 6 - Field install)	233215		\$90

## BRUSH GRAPPLES

### HEAVY-DUTY BRUSH GRAPPLES (DUAL CYLINDER)

**NEW PRODUCT**



- 6" tine spacing
- Standard cylinder guards protect all cylinder components
- 1.25" cylinder pivot pins
- 1.25" x 24" full length grapple pins greatly reduce torsional force
- .375" end plates on Tractor Duty end plates and .5" end plates on Standard and Heavy Duty
- Cushioned and sleeved cylinders are 2" x 8" x 1.25"
- Standard load check valve
- 100,000 PSI tensile yield strength tines

Carrier Specifications	
Lift Capacity	Operating Weight
<5,000 lbs.	<9,500 lbs.

Specifications							
Model	Weight (approx)	Width	Depth	Grapple Opening	Grapple Closed	Tines	Tine Thickness
32172-0022	995 lbs	72"	39"	40"	29"	14	0.5"
32178-0022	1010 lbs	78"	39"	40"	29"	14	0.5"
32184-0022	1070 lbs	84"	39"	40"	29"	16	0.5"

### HEAVY-DUTY BRUSH GRAPPLES FOR SKID-STEER LOADERS



**INCLUDES: GRAPPLE, UNIVERSAL SSL MOUNTING AND HOSE/COUPLER KITS**

HEAVY-DUTY BRUSH GRAPPLE	ORDER CODE	SHIP WEIGHT (LBS)	LIST PRICE
72" heavy-duty brush grapple	32172-0022	925	\$6,355
78" heavy-duty brush grapple	32178-0022	999	\$6,694
84" heavy-duty brush grapple	32184-0022	1054	\$7,029

OPTIONS	ORDER CODE	SHIP WEIGHT (LBS)	LIST PRICE
Stop Kit - John Deere G-Series* * Stops to be used on John Deere G-Series to prevent hydraulic coupler interference.	239072	6	\$79

# GRAPPLES

## BRUSH GRAPPLES

### HEAVY-DUTY BRUSH GRAPPLE (DUAL CYLINDER)



- 84" wide
- Dual independent see through grapples
- Cylinder protection
- Hydraulic hose protection

### HEAVY-DUTY BRUSH GRAPPLE FOR TRACTOR LOADERS/ BACKHOES AND WHEEL LOADERS

	ORDER CODE	SHIP WEIGHT (LBS)	LIST PRICE
78" Heavy Duty brush grapple, Universal SSL Hitch	236349	1529	\$11,938
84" Heavy Duty brush grapple, Universal SSL Hitch	236341	1552	\$12,238
98" Heavy Duty brush grapple, Universal SSL Hitch	236344	1683	\$14,058
Case 570LXT/MXT, 580L/M & SL/SM pin on	101040	1654	\$17,198
Cat IT / TH	13067	1654	\$15,216
John Deere 210LE pin on	13004	1725	\$14,624
JCB 506/508	12726	1520	\$15,350
JCB Q-fit	12867	1823	\$16,778
New Holland LB75 Pin-on Mtg 1800	13212	1800	\$14,421
New Holland LM 640 - Versattach	12867	1823	\$16,778
QCP7000 interchange	13127	1785	\$13,788



### STANDARD-DUTY BRUSH GRAPPLE (SINGLE CYLINDER)



- Aggressive grapples made of high strength steel for maximum performance and durability
- Cylinder guard design protects cylinder while preventing build-up of debris
- Provides excellent visibility

Specifications					
Model	Width	Weight (approx)	Height Open	Height Closed	Length
108597	48"	300 lbs	29"	25.5"	30.5"
108598	54"	315 lbs	29"	25.5"	30.5"
108415	72"	435 lbs	29"	25.5"	30.5"

### STANDARD-DUTY BRUSH GRAPPLE FOR COMPACT TRACTORS



HOSES & COUPLERS NOT INCLUDED	ORDER CODE	SHIP WEIGHT (LBS)	LIST PRICE
48" brush grapple (single cylinder)	108597	300	\$2,526
54" brush grapple (single cylinder)	108598	315	\$2,741
72" brush grapple (dual cylinder)	108415	435	\$4,198
Options			
48" bolt-on bar assembly	107158	26	\$180

## BRUSH GRAPPLES

### STANDARD-DUTY BRUSH GRAPPLE (DUAL CYLINDER)



**NEW PRODUCT**

- Open floor design
- Features grapple pins and cushioned cylinders
- 80,000 PSI tensile yield strength tines
- Available in 60", 66" and 72" widths

Carrier Specifications	
Lift Capacity	Operating Weight
<4,000 lbs.	<6,500 lbs.

Specifications								
Model	Weight (approx)	Width	Depth	Grapple Opening	Grapple Closed	Tines	Tine Thickness	
32060-0022	668 lbs	60"	36"	33"	29"	9	0.4"	
32066-0022	696 lbs	66"	36"	33"	29"	10	0.4"	
32072-0022	724 lbs	72"	36"	33"	29"	11	0.4"	
32084-0022	817 lbs	84"	36"	33"	29"	13	0.4"	

### STANDARD-DUTY BRUSH GRAPPLE (DUAL CYLINDER) FOR SKID-STEER LOADERS



**INCLUDES: GRAPPLE, UNIVERSAL SSL MOUNTING AND HOSE/COUPLER KITS**

GRAPPLE ASSEMBLIES	ORDER CODE	SHIP WEIGHT (LBS)	LIST PRICE
60" standard-duty brush grapple	32060-0022	668	\$5,440
66" standard-duty grapple	32066-0022	696	\$5,748
72" standard-duty grapple	32072-0022	724	\$5,864
84" standard-duty grapple	32084-0022	817	\$6,486

OPTIONS	ORDER CODE	SHIP WEIGHT (LBS)	LIST PRICE
Load check valve	239168		POR

# GRAPPLES

## SCRAP GRAPPLES

### HEAVY-DUTY SCRAP GRAPPLES (DUAL CYLINDER)



- Standard cylinder guards protect all cylinder components
- Standard load check valve
- 1.25" cylinder pivot pins with spherical bearings
- 1.25" x 24" full length grapple pins reduce torsional force
- Cushioned cylinders are 2" x 8" x 1.25"
- Optional, reversible .75" x 8" double bevelled edge
- Secluded grease zerks protects from damage

Specifications					
Model	Weight (approx)	Width	Depth	Grapple Open	Grapple Closed
11876-0022	1081 lbs	77"	39"	40"	29"
11882-0022	1133 lbs	83"	39"	40"	29"
11888-0022	1180 lbs	89"	39"	40"	29"

### HEAVY-DUTY SCRAP GRAPPLES FOR SKID-STEER LOADERS



**INCLUDES: GRAPPLE AND UNIVERSAL SSL MOUNTING  
TO ORDER: CHOOSE GRAPPLE AND HOSE COUPLER KIT**

HEAVY-DUTY SCRAP GRAPPLE - KITS	ORDER CODE	SHIP WEIGHT (LBS)	LIST PRICE
76" heavy-duty scrap grapple, 88" hoses included, bolt-on edge included	123671	1202	\$6,994
82" heavy-duty scrap grapple, 88" hoses included, bolt-on edge included	123672	1253	\$7,429
88" heavy-duty scrap grapple, 88" hoses included, bolt-on edge included	123673	1297	\$8,151

HEAVY-DUTY SCRAP GRAPPLE	ORDER CODE	SHIP WEIGHT (LBS)	LIST PRICE
76" heavy-duty scrap grapple	11876-0022	1081	\$6,478
82" heavy-duty scrap grapple	11882-0022	1133	\$7,043
88" heavy-duty scrap grapple	11888-0022	1180	\$7,502

HOSE/COUPLER KIT	ORDER CODE	SHIP WEIGHT (LBS)	LIST PRICE
<b>Required for Heavy-Duty Grapples</b>			
60" Hose Kit	MTG1113-0022	14	\$442
80" Hose Kit	MTG1113-0903	18	\$541
80" Hose Kit with 90° couplers (use for Bobcat M Series)	MTG1113-0319	20	\$541
88" Hose Kit	MTG1113-9783	21	\$570
96" Hose Kit	117285	23	\$600

OPTIONAL REVERSIBLE CUTTING EDGE KIT	ORDER CODE	SHIP WEIGHT (LBS)	LIST PRICE
76" bolt-on edge for construction grapple	11800		\$682
82" bolt-on edge for construction grapple	15029		\$730
88" bolt-on edge for construction grapple	11801		\$794
Option: Side plate extension (Customer to drill holes)	LAF5250-0000		\$368

## SCRAP GRAPPLES

### MODEL 120 STANDARD-DUTY SCRAP GRAPPLE (DUAL CYLINDER)



- The strength and design of the Model 120 grapple make it the ideal attachment for scrap yards, recycling and construction sites
- Features grapple pins
- Optional bolt on edges, cushioned cylinders, hardened pins and cylinder and hose guards available

Carrier Specifications	
Lift Capacity	Operating Weight
<9,000 lbs.	<11,000 lbs.

Specifications					
Model #	Weight	Width ID	Open	Closed	Depth
LAF5073	1,266 lbs	74"	45.4"	19.1"	37.8"
LAF5078	1,301 lbs	79"	45.4"	19.1"	37.8"
LAF5082	1,329 lbs	83"	45.4"	19.1"	37.8"
LAF5087	1,364 lbs	88"	45.4"	19.1"	37.8"
LAF5273	1,303 lbs	74"	45.4"	19.1"	37.8"
LAF5278	1,514 lbs	79"	45.4"	19.1"	37.8"
LAF5282	1,542 lbs	83"	45.4"	19.1"	37.8"
LAF5287	1,577 lbs	88"	45.4"	19.1"	37.8"



**IMPORTANT:** All wheel loaders must have an OEM supplied flow limiter/reducer type valve installed on the tilt circuit. All replacement hydraulic hoses and fittings must have a minimum rated working pressure of 4000 psi.

### MODEL 120 STANDARD-DUTY SCRAP GRAPPLES FOR SKID-STEER LOADERS



**INCLUDES: GRAPPLE, UNIVERSAL SSL MOUNTING, 78" HOSES AND 1/2" BODY QD'S**  
**TO ORDER: CHOOSE GRAPPLE AND MOUNTING**

STANDARD FEATURED GRAPPLE BUCKET CHECK LOADER CAPACITY BEFORE ORDERING			
	ORDER CODE	SHIP WEIGHT (LBS)	LIST PRICE
<b>Includes Cushioned Cylinders</b>			
74" ID Scrap Grapple Bucket	LAF5073-0022	1266	\$7,761
79" ID Scrap Grapple Bucket	LAF5078-0022	1301	\$7,968
83" ID Scrap Grapple Bucket	LAF5082-0022	1329	\$8,140
88" ID Scrap Grapple Bucket	LAF5087-0022	1364	\$8,375
FULL FEATURED GRAPPLE BUCKET CHECK LOADER CAPACITY BEFORE ORDERING			
	ORDER CODE	SHIP WEIGHT (LBS)	LIST PRICE
<b>Includes Cushioned Cylinder Kit, Hardened Pin and Cylinder/Hose Guard</b>			
74" ID Scrap Grapple Bucket	LAF5273-0022	1303	\$7,710
79" ID Scrap Grapple Bucket	LAF5278-0022	1514	\$7,891
83" ID Scrap Grapple Bucket	LAF5282-0022	1542	\$8,073
88" ID Scrap Grapple Bucket	LAF5287-0783	1577	\$8,865

MODEL 120 SCRAP GRAPPLE CONTINUED NEXT PAGE

# GRAPPLES

## SCRAP GRAPPLES

### MODEL 120 STANDARD-DUTY SCRAP GRAPPLE (DUAL CYLINDER)

#### MODEL 120 STANDARD-DUTY SCRAP GRAPPLES FOR SKID-STEER LOADERS CONT.

MOUNTING		ORDER CODE	SHIP WEIGHT (LBS)	
Contact Customer Service at (833) 723-1843				
OPTIONS - REVERSIBLE CUTTING EDGE KIT		ORDER CODE	SHIP WEIGHT (LBS)	LIST PRICE
<b>includes BOE, grade 8 plow bolts, lock washers &amp; nuts</b>				
For LAF5073 & LAF5273 (7 holes, 11" spacing)		15028	120	\$552
For LAF5078 & LAF5278 (9 holes, 9" spacing)		16204	130	\$700
For LAF5082 & LAF5282 (9 holes, 9.75" spacing)		15029	136	\$730
For LAF5087 & LAF5287 (14 holes, 6" spacing)		113978	168	\$963
<b>Accessories (Add-ons or replacement parts)</b>				
Cylinder/Hose Guard Kit for Model 120		LAF5004-0000	57	\$593
End Plate Extensions - Full Kit for Model 120 & construction		LAF5250-0000	30	\$368
NOTE: Field installation required on hardened pin, and cylinder hose guard kits				
TOOTHBARS - *Exclusive to FFC Buckets		ORDER CODE	SHIP WEIGHT (LBS)	LIST PRICE
<b>Heavy-Duty Toothbar for Buckets without Bolt-On Edge</b>				
For LAF5073 & LAF5273 with 8 teeth		10543	127	\$1,285
For LAF5082 & LAF5282 with 10 teeth		10569	151	POR
<b>Heavy-Duty Toothbar for Buckets with Bolt-On Edge</b>				
For LAF5078 & LAF5278 with 8 teeth		10554	159	\$1,415
For LAF5082 & LAF5282 with 10 teeth		10570	186	POR
<b>Extra Heavy-Duty Toothbar for Buckets without Bolt-On Edge</b>				
For LAF5073 & LAF5273 with 8 teeth		10607	129	\$1,808

## SCRAP GRAPPLES

### HEAVY-DUTY SCRAP GRAPPLE (DUAL CYLINDER)



- Abrasion resistant cutting edge with punched holes for optional bolt on edges
- Cut away side plate
- Dual arms with po checks to grab uneven loads

### HEAVY-DUTY SCRAP GRAPPLE FOR TRACTOR LOADERS/BACKHOES



		ORDER CODE	SHIP WEIGHT (LBS)	LIST PRICE
<b>.78 YD SCRAP GRAPPLE</b>				
JCB 210S/212S 75" wide	edge group 100831	11509	1350	\$11,810
<b>1.00 YD SCRAP GRAPPLE</b>				
JCB 520 78" wide	edge group 12597	11850	1284	\$12,750
JCB 520 & 524 88" wide	edge group 24508	12783	1550	\$12,750
Manitou 90" wide	edge group 12297	12773	1375	\$12,750
Universal Hitch 73" wide	edge group 15025	13134	1130	\$10,830
<b>1.25 YD SCRAP GRAPPLE</b>				
New Holland LB90/110 90" wide	edge group C	12405	1693	\$12,250
<b>1.75 YD SCRAP GRAPPLE</b>				
Cat IT/TH	edge group A	12439	1800	\$12,810
Gehl DynacARRIER	edge group B	12741	1750	\$14,915
Gradall G6-42A		12700	1690	\$12,890
Manitou hitch		12847	1700	\$12,810
SkyTrak	edge group B	12759	1800	\$12,841
<b>2.50 YD SCRAP GRAPPLE</b>				
Cat IT/TH	edge group A	15201	2440	\$14,880

### HEAVY-DUTY SCRAP GRAPPLE FOR WHEEL LOADERS



		ORDER CODE	SHIP WEIGHT (LBS)	LIST PRICE
<b>.78 YD SCRAP GRAPPLE</b>				
JCB 409 old style with edge 78" wide		12434	1350	\$11,810
<b>1.00 YD SCRAP GRAPPLE</b>				
Cat 902/906/908 88" wide	edge group 24508	11053	1550	\$12,750
Case 221D/321D 88" wide	edge group 24508	12512	1572	\$12,750
JCB 407/409 88" wide 1.25 yd	edge group 24508	12738	1875	\$11,122
JCB 75" wide 407 / 409A	edge group 14989	12719	1650	\$12,750
Komatsu WA65 / 75 / 85 / 95	edge group 14989	12719	1650	\$12,750
New Holland LW80 88" wide	edge group 24508	12512	1572	\$12,750
Universal Hitch 73" wide	edge group 15025	13134	1130	\$10,830
<b>1.75 YD SCRAP GRAPPLE</b>				
Case 521 D pin on	edge group A	13028	2025	\$12,810
<b>2.50 YD SCRAP GRAPPLE</b>				
Cat IT14/IT24 96" wide	edge group A	12311	3000	\$14,880
JRB 416 series lugs 2.25 yd		12723	3050	\$13,350

# GRAPPLES

## SCRAP GRAPPLES

### MODEL 130 HEAVY-DUTY SCRAP GRAPPLE BUCKET



- 1.5" x 27.125" grapple pins reduce torsional force
- 1.5" x 8.625" heat-treated, greaseable pivot pins
- Optional cushioned and sleeved cylinders: 2.5" x 8"x 1.75"
- Bucket edge drilled for FFC replaceable edge unless specified

Carrier Specifications	
Lift Capacity	Operating Weight
<10,000 lbs.	<18,000 lbs.

Specifications						
Model	Weight (approx)	Width ID	Open	Closed	Depth	Cubic Yards
LAF5283	1,665 lbs	83"	47.4"	21.8"	37.3"	1 yd <sup>3</sup>
LAF5294	1,745 lbs	94"	47.4"	21.8"	37.3"	1.25 yd <sup>3</sup>



**IMPORTANT:** All wheel loaders must have an OEM supplied flow limiter/reducer type valve installed on the tilt circuit. All replacement hydraulic hoses and fittings must have a minimum rated working pressure of 4000 psi.

### MODEL 130 SCRAP GRAPPLE BUCKET FOR TRACTOR LOADERS/ BACKHOES AND WHEEL LOADERS



**INCLUDES: GRAPPLE , LIST PRICE OF LOADER MOUNTING MUST BE ADDED TO ATTACHMENT LIST PRICE  
TO ORDER: CHOOSE GRAPPLE AND MOUNTING**

GRAPPLE BUCKET			
CHECK LOADER CAPACITY BEFORE ORDERING			
	ORDER CODE	SHIP WEIGHT (LBS)	LIST PRICE
83" ID Scrap Grapple Bucket	LAF5283	1665	\$11,800
94" ID Scrap Grapple Bucket	LAF5294	1745	\$12,229
OPTIONAL - REVERSIBLE CUTTING EDGE KIT			
INCLUDES BOE, GRADE 8 PLOW BOLTS, LOCK WASHERS & NUTS			
	ORDER CODE	SHIP WEIGHT (LBS)	LIST PRICE
For LAF5283 (9 holes, 9.75" spacing)	15029	NA	\$730
For LAF5294 (15 holes, 6" spacing)	FFC10083	195	\$954
For Optional Bolt-On Edge Drill Patterns (i.e. Case Hole Patterns) - Call (833) 723-1843			
OPTIONS			
	ORDER CODE	SHIP WEIGHT (LBS)	LIST PRICE
Heavy-Duty Toothbar for Buckets without Bolt-On Edge - Exclusive to FFC Buckets			
For LAF5283 with 10 teeth	10569	151	\$170
Heavy-Duty Toothbar for Buckets with Bolt-On Edge - Exclusive to FFC Buckets			
For LAF5283 with 10 teeth	10570	186	\$398

FOR CUSTOM TOOTHBARS OR TOOTHBARS WITHOUT FFC BOLT-ON EDGE - CALL (833) 723-1843  
SEE TOOTHBAR SECTION FOR CUSTOM TOOTHBAR OPTIONS

End Plate Extension - Full Kit for Model 130	LAF5252-0000	50	\$773
--	--------------	----	-------

NOTE: Field installation required on hardened pin, cushioned cylinder and cylinder hose guard kits

## SCRAP GRAPPLES

### STANDARD-DUTY SCRAP GRAPPLE (DUAL CYLINDER)



- Standard cylinder guards protect all cylinder components
- Standard load check valve
- 1.25" cylinder pivot pins with spherical bearings
- 1.25" x 24" full length grapple pins reduce torsional force
- Cushioned cylinders are 2" x 8" x 1.25"
- Optional, reversible .75" x 8" double bevelled edge
- Secluded grease zerks protects from damage

Specifications					
Model	Weight (approx)	Width	Depth	Grapple Open	Grapple Closed
12860-0022	738 lbs	61"	34"	34"	29"
12866-0022	788 lbs	67"	34"	34"	29"
12872-0022	835 lbs	73"	34"	34"	29"



### STANDARD-DUTY SCRAP GRAPPLE (DUAL CYLINDER) FOR SKID-STEER LOADERS

GRAPPLE ASSEMBLIES	ORDER CODE	SHIP WEIGHT (LBS)	LIST PRICE
<b>Standard-Duty Scrap Grapple Assembly (hose/coupler kit is not included)</b>			
60" standard-duty scrap grapple	12860-0022	738	\$5,759
66" standard-duty scrap grapple	12866-0022	788	\$5,881
72" standard-duty scrap grapple	12872-0022	835	\$6,218

HOSE/COUPLER KIT	ORDER CODE	SHIP WEIGHT (LBS)	LIST PRICE
<b>Required for Utility Grapples</b>			
60" Hose Kit	MTG1113-0022	14	\$442
80" Hose Kit	MTG1113-0903	18	\$541
80" Hose Kit with 90° couplers (use for Bobcat M Series)	MTG1113-0319	20	\$541
88" Hose Kit	MTG1113-9783	21	\$570
96" Hose Kit	117285	23	\$600

OPTIONAL REVERSIBLE CUTTING EDGE KIT	ORDER CODE	SHIP WEIGHT (LBS)	LIST PRICE
60" bolt-on edge for utility grapple	15025	98	POR
66" bolt-on edge for utility grapple	15027	108	\$550
72" bolt-on edge for utility grapple	15028	117	\$552

# GRAPPLES

## SCRAP GRAPPLE BUCKET

- Available in 60", 66", and 72" widths
- Low profile sides to allow longer pieces of scrap or debris in the bucket

## SCRAP GRAPPLE BUCKET FOR COMPACT TRACTORS



	ORDER CODE	SHIP WEIGHT (LBS)	LIST PRICE
60" scrap grapple bucket	10705-60-0822		\$4,693
66" scrap grapple bucket	10705-66-0822		\$4,929
72" scrap grapple bucket	10705-72-0822		\$5,165

## LOG GRAPPLE



- Excellent attachment for handling logs, pipes, brush, and other bulky materials
- 2" x 8" hydraulic cylinder
- Closes to 6" log or pipe

Carrier Specifications	
Lift Capacity	Operating Weight
<10,000 lbs.	<20,000 lbs.

Specifications							
Model	Weight (approx)	Lift Capacity	Height OD	Depth	Usable Tooth	Grapple Open	Tine Length
LAF1142	790 lbs	6,400 lbs	48.6"	37.85"	28.4"	49.3"	29"

## LOG GRAPPLE FOR SKID-STEER LOADERS



**INCLUDES: LOG GRAPPLE, UNIVERSAL SSL MOUNTING, AND HOSES AND COUPLERS TO ORDER: CHOOSE GRAPPLE AND MOUNTING**

LOG GRAPPLE	ORDER CODE	SHIP WEIGHT (LBS)	LIST PRICE
<b>CHECK LOADER CAPACITY BEFORE ORDERING</b>			
Log Grapple 42" tines	LAF1142-0022	790	\$6,750

MOUNTING	ORDER CODE	SHIP WEIGHT (LBS)
<b>ADDITIONAL COST MAY APPLY</b>		
Contact Customer Service at (833) 723-1843		

## SKELETON FORK & GRAB



- Easy handling of scrap pallets and yard waste in recycling applications
- Designed for tub grinder charging
- Open tines allow dirt to drop out, which increases tub grinder life

## SKELETON FORK & GRAB FOR WHEEL LOADERS

	ORDER CODE	SHIP WEIGHT (LBS)	LIST PRICE
Cat IT/TH	12161	2335	\$16,960
Cat IT/TH with enclosed sides	12510	2445	\$17,250



## TRASH CLAMP



- Single grapple to hold paper waste inside the bucket
- Designed to clamp and hold loose material
- Works well with any loose material needing secured for transporting or loading

## TRASH CLAMP FOR WHEEL LOADERS

	ORDER CODE	SHIP WEIGHT (LBS)	LIST PRICE
<b>1.75 YD TRASH CLAMP (GRAPPLE)</b>			
JCB 416HT	edge group B	12537	1625
			\$9,968



# GRAPPLES

## LAND SCULPTOR



- Levels all types of soil by cutting high spots & filling depressions
- Can be used as a carry-all
- Optional comb breaks up dirt chunks & smooths surface
- Optional scarifiers dig into packed dirt

### LAND SCULPTOR FOR SKID-STEER LOADERS



	ORDER CODE	SHIP WEIGHT (LBS)	LIST PRICE
78" land sculptor assembly	106400	515	\$2,843
<b>Options</b>			
comb assembly	106379	109	\$676
scarifier tooth assembly	107009	59	\$651
bolt-on cutter bar	16204	127	\$700

Add Surcharge to all products 8.85%

## FORK MOUNTED CRANE HOOK

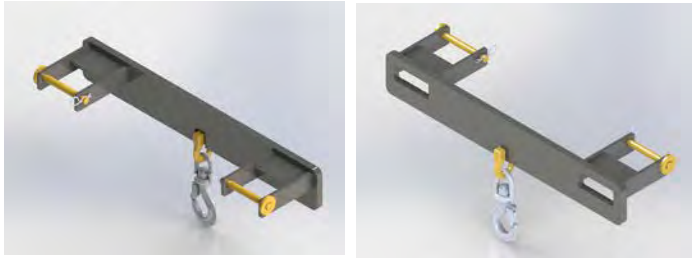

- 4,000 to 10,000 lb capacities
- Swivel hook with safety latch
- Fork mounted for easy use
- Excellent utility tool

## FORK MOUNTED CRANE HOOK FOR TELEHANDLERS AND TRACTOR LOADERS/BACKHOES



	ORDER CODE	SHIP WEIGHT (LBS)	LIST PRICE
4,000 lb	11985	104	\$1,170
10,000 lb	12398	122	\$1,327

## LIFTING HOOK



- 12,000 lb capacity

## LIFTING HOOK FOR TELEHANDLERS



	ORDER CODE	SHIP WEIGHT (LBS)	LIST PRICE
Case 688	19716	230	\$2,172
Cat IT/TH	12971	219	\$2,172
Ingersoll Rand VR642-1056	19716	230	\$2,172
JLG "G" series	12992	224	\$2,172
John Deere 310 QA	119134	435	\$2,172
Manitou (serial # <0160037670)	13094	276	\$2,172
New Holland LM-A	13094	276	\$2,172

# HYDRAULICS

## AUXILIARY HYDRAULIC CONVERSION KIT

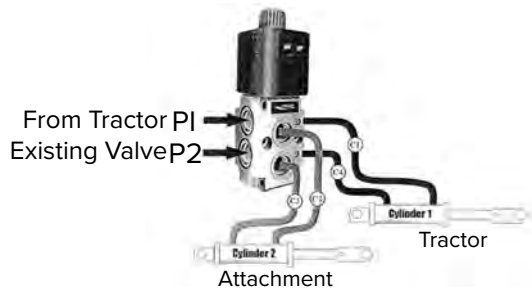

- Converts existing tractor loader to two-function hydraulics

## AUXILIARY HYDRAULIC CONVERSION KIT FOR COMPACT TRACTORS



	ORDER CODE	SHIP WEIGHT (LBS)	LIST PRICE
converts existing tractor loader to two-function hydraulics	109052	45	\$1,324

Add Surcharge to all products 8.85%

## MANURE PUSH



- Ideal for waste water, manure, feed lots, flood clean-up
- Moves large volumes of snow efficiently
- Rubber edge 1 ft x 6" on scraper & pull back

Specifications				
Model	Width (overall)	Height (overall)	Depth (overall)	Weight (lbs)
10711-60	60"	28"	29"	227
10711-72	72"	28"	29"	313
10711-84	84"	28"	29"	349
10711-96	96"	28"	29"	385

## MANURE PUSH FOR COMPACT TRACTORS



	ORDER CODE	SHIP WEIGHT (LBS)	LIST PRICE
60" manure push	10711-60-0822	227	\$1,985
72" manure push	10711-72-0822	313	\$2,678
84" manure push	10711-84-0822	349	\$3,701
96" manure push	10711-96-0822	385	\$4,850

Add Surcharge to all products 8.85%

Add Surcharge to all products 8.85%

# MINI ATTACHMENTS



# MINI ATTACHMENTS

## MINI ATTACHMENTS FOR COMPACT TOOL CARRIERS AND MINI SKID-STEER LOADERS



### MINI ADAPTERS

- For universal attachment & 3 point
- Weld-on adapters available
- Tilt attach adapters available



UNIVERSAL ATTACHMENT	ORDER CODE	SHIP WEIGHT (LBS)	LIST PRICE
<b>For Use On Machine Listed</b>			
ASV/Polaris to mini attachment	2003866	100	\$1,006
Bobcat MT50/52 to mini attachment	18193	150	\$1,075
New Holland LS120/LS125 to mini attachment	19541	65	\$831
Thomas 85 to mini attachment	2006646	75	\$1,000
3-point Cat I to mini attachment	101160	52	\$970
mini universal to Bobcat MT50/52 attachments	103633	71	\$1,079
mini skid steer to skid steer loader universal adapter	123794	164	\$2,519



WELD-ON ADAPTER	ORDER CODE	SHIP WEIGHT (LBS)	LIST PRICE
universal hitch	31629	29	\$179
ASV/Polaris	16647	62	\$416
Bobcat MT50/52	16142	74	\$410
Gehl	17699	25	\$263
New Holland LS120/LS125	23973	30	\$184
Thomas 85	2006645	37	\$313

weld to your attachment for mounting to mini-skid listed



TILT ATTACH ADAPTER	ORDER CODE	SHIP WEIGHT (LBS)	LIST PRICE
mini universal tilt attach includes hoses & flat face couplers	100145	94	\$2,203
Bobcat MT50/52 to mini universal mount	103246	160	\$2,460

Add Surcharges to all products 8.85%

## MINI ATTACHMENTS FOR COMPACT TOOL CARRIERS AND MINI SKID-STEER LOADERS

**NEW PRODUCT**

### CS SERIES MINI AUGER DRIVES



- Advanced gearing standard for increased life and efficiency
- Secure lock shaft
- Compact housing design for easy handling and increased strength and durability
- Oversized bearing for improved load handling
- Extreme shaft seals for reduced service intervals
- Compact, high torque, efficient hydraulic motors for improved drilling productivity
- Easy access service points for user friendly maintenance
- Full connection contact between auger hub and auger drive unit

### CS SERIES AUGER DRIVES FOR COMPACT TOOL CARRIERS



**INCLUDES: AUGER DRIVE ONLY. YOU MUST ORDER MOUNTING KIT, AUGER BITS, AND EXTENSIONS SEPARATELY.**

CS SERIES AUGER DRIVES Hose routed out the side			
	ORDER CODE	SHIP WEIGHT (LBS)	LIST PRICE
CS 11-12 2.56" Round Auger Drive, 0.8 - 2 MT	810231N	130	\$2,190
CS 11-12 2" Hex Auger Drive, 0.8 - 2 MT	810232N	130	\$2,190
CS 16-15 2.56" Round Auger Drive, 1 - 2.5 MT	810237N	130	\$2,190
CS 16-15 2" Hex Auger Drive, 1 - 2.5 MT	810238N	130	\$2,190
CS 20-17 2.56" Round Auger Drive, 2 - 3 MT	810243N	130	\$2,260
CS 20-17 2" Hex Auger Drive, 2 - 3 MT	810244N	130	\$2,260
MOUNT			
	ORDER CODE	SHIP WEIGHT (LBS)	LIST PRICE
CII Mount Assembly	239280	111	\$800
MT50/52/100 CTC Mount Assembly	239283	157	\$900

### CS SERIES KITTED BUNDLES FOR COMPACT TOOL CARRIERS



**INCLUDES: MOUNT, DRIVE, AND SELECT BUNDLES INCLUDE QUICK DISCONNECT FITTINGS. SEE TABLE FOR PROPER OUTPUT SHAFT AND DETAILS.**

CTC MOUNT BUNDLES Hose routed out the side						
ORDER CODE	DESCRIPTION	OUTPUT SHAFT	MOUNT	QD INCLUDED	SHIP WEIGHT (LBS)	LIST PRICE
810237N-0961	CS 16-15 AUGER DRIVE	2.563 IN ROUND	CII	1/2	181	\$3,125
810238N-0961	CS 16-15 AUGER DRIVE	2 IN HEX	CII	1/2	181	\$3,125
810243N-0961	CS 20-17 AUGER DRIVE	2.563 IN ROUND	CII	1/2	181	\$3,195
810244N-0961	CS 20-17 AUGER DRIVE	2 IN HEX	CII	1/2	181	\$3,195
810237N-0128	CS 16-15 AUGER DRIVE	2.563 IN ROUND	Bobcat	1/2	181	\$3,125
810238N-0128	CS 16-15 AUGER DRIVE	2 IN HEX	Bobcat	1/2	181	\$3,125
810243N-0128	CS 20-17 AUGER DRIVE	2.563 IN ROUND	Bobcat	1/2	181	\$3,195
810244N-0128	CS 20-17 AUGER DRIVE	2 IN HEX	Bobcat	1/2	181	\$3,195

# MINI ATTACHMENTS

## MINI ATTACHMENTS FOR COMPACT TOOL CARRIERS AND MINI SKID-STEER LOADERS



### MINI AUGERS CONT.

AUGER BITS	ORDER CODE	LIST PRICE
<b>3' Aggressor Augers 2" Hex</b>		
6" x 3' aggressor auger 2" hex	236011	\$406
9" x 3' aggressor auger 2" hex	236012	\$498
12" x 3' aggressor auger 2" hex	236013	\$551
15" x 3' aggressor auger 2" hex	236014	\$726
18" x 3' aggressor auger 2" hex	236015	\$846
24" x 3' aggressor auger 2" hex	243160	\$725
30" x 3' aggressor auger 2" hex	243161	\$967
36" x 3' aggressor auger 2" hex	243162	\$1,200
<b>3' Aggressor Augers 2.56" Round</b>		
6" x 3' aggressor auger 2.56" round	236016	\$406
9" x 3' aggressor auger 2.56" round	236017	\$498
12" x 3' aggressor auger 2.56" round	236018	\$551
15" x 3' aggressor auger 2.56" round	236019	\$726
18" x 3' aggressor auger 2.56" round	236020	\$846
24" x 3' aggressor auger 2.56" round	243163	\$725
30" x 3' aggressor auger 2.56" round	243164	\$967
36" x 3' aggressor auger 2.56" round	243165	\$1,200
<b>3' Trimax Augers 2" Hex</b>		
6" x 3' trimax auger 2" hex	243166	\$445
9" x 3' trimax auger 2" hex	243167	\$530
12" x 3' trimax auger 2" hex	243168	\$625
16" x 3' trimax auger 2" hex	243169	\$739
18" x 3' trimax auger 2" hex	243170	\$879
24" x 3' trimax auger 2" hex	243171	\$1,080
30" x 3' trimax auger 2" hex	243172	\$1,290
36" x 3' trimax auger 2" hex	243173	\$1,444

AUGER BITS	ORDER CODE	LIST PRICE
<b>3' Trimax Augers 2.56" Round</b>		
6" x 3' trimax auger 2.56" round	243174	\$445
9" x 3' trimax auger 2.56" round	243175	\$530
12" x 3' trimax auger 2.56" round	243176	\$625
16" x 3' trimax auger 2.56" round	243177	\$739
18" x 3' trimax auger 2.56" round	243178	\$879
24" x 3' trimax auger 2.56" round	243179	\$1,080
30" x 3' trimax auger 2.56" round	243180	\$1,290
36" x 3' trimax auger 2.56" round	243181	\$1,444
<b>3' Mini Aggressor Augers 2.56" Round</b>		
6" x 3' aggressor auger 2.56" round	243187	\$495
9" x 3' aggressor auger 2.56" round	243188	\$525
12" x 3' aggressor auger 2.56" round	243189	\$555
15" x 3' aggressor auger 2.56" round	243190	\$585
18" x 3' aggressor auger 2.56" round	243191	\$615
<b>3' Mini Aggressor Augers 2" Hex</b>		
6" x 3' aggressor auger 2" hex	243182	\$495
9" x 3' aggressor auger 2" hex	243183	\$525
12" x 3' aggressor auger 2" hex	243184	\$555
15" x 3' aggressor auger 2" hex	243185	\$585
18" x 3' aggressor auger 2" hex	243186	\$615

Add Surcharges to all products 800-850-910

## MINI ATTACHMENTS FOR COMPACT TOOL CARRIERS AND MINI SKID-STEER LOADERS

### MINI ANGLE BROOM (SWEEPER)



- 26" diameter brush heads
- 42", 48", and 60" widths
- Polypropylene and mixed poly/wire brushes available
- Optional dirt deflectors



**Note:** The sweeper is mounted to, and raised by the loader arms. The brush is powered from the Compact Tool Carrier 3rd function valve. There is a 10-16 GPM hydraulic flow required at 2000-2500 PSI. For Compact Tool Carriers with lift capacity under 1300 lbs.



**INCLUDES:** 26" DIAMETER BRUSH, WITH QUICK-CHANGE CORE, UNIVERSAL MINI MOUNTING, CONTROL BOX WITH POWER LEAD, AND MANUAL ANGLE AS STANDARD EQUIPMENT.



MINI ANGLE BROOM (SWEEPER)		ORDER CODE	SHIP WEIGHT (LBS)	LIST PRICE
<b>BRUSH HEAD AND BRUSH MATERIAL</b>				
<b>26" Diameter Brush Heads - All Polypropylene Brush GPM Range 4-8</b>				
CTC26 42" hydraulic sweeper	22641PM-0961	340	\$6,091	
CTC26 48" hydraulic sweeper	22647PM-0961	380	\$6,091	
<b>26" Diameter Brush Heads - Mixed Polypropylene &amp; Wire Brush GPM Range 4-8</b>				
CTC26 42" hydraulic sweeper	22641MM-0961	340	\$6,091	
CTC26 48" hydraulic sweeper	22647MM-0961	380	\$6,091	
<b>26" Diameter Brush Heads - All Polypropylene Brush GPM Range 6-12</b>				
CTC26 42" hydraulic sweeper	22642PM-0961	340	\$6,092	
CTC26 48" hydraulic sweeper	22648PM-0961	380	\$6,091	
CTC26 60" hydraulic sweeper	22660PM-0961	440	\$6,091	
<b>26" Diameter Brush Heads - Mixed Polypropylene &amp; Wire Brush GPM Range 6-12</b>				
CTC26 42" hydraulic sweeper	22642MM-0961	340	\$6,091	
CTC26 48" hydraulic sweeper	22648MM-0961	380	\$6,091	
CTC26 60" hydraulic sweeper	22660MM-0961	440	\$6,091	
<b>ANGLE TYPE MANUAL OR HYDRAULIC (ONE REQUIRED)</b>		ORDER CODE	SHIP WEIGHT (LBS)	LIST PRICE
manual angle change		M	n/a	
hydraulic angle change with electric valve - 12 volt		H	22	
<b>Hydraulic Angle Change with Electric Valve Control Options - For Replacement</b>				
Control box w/ power lead		28-10754	5	\$383
<b>MOUNTING (ONE REQUIRED)</b>		ORDER CODE	SHIP WEIGHT (LBS)	
Contact Customer Service for correct mount for your CTC make and model - (833) 723-1843			n/a	
<b>OPTIONS</b>		ORDER CODE	SHIP WEIGHT (LBS)	LIST PRICE
conversion kit manual to hydraulic with box		11-5433	15	\$3,112
conversion kit manual to hydraulic without box		11-4191	6	\$827
<b>Side Mount Caster Wheels</b>				
side mount caster wheels S26		28-10498	45	\$1,589

# MINI ATTACHMENTS

## MINI ATTACHMENTS FOR COMPACT TOOL CARRIERS AND MINI SKID-STEER LOADERS

**NEW PRODUCT**

### MINI DIRT BUCKETS



HEAVY DUTY

Carrier Specifications
Lift Capacity
Standard Duty - 1500 lbs.
Heavy Duty - 2500 lbs.

- Optional Bolt on Edge, Tooth Bar, and Teeth
- Wear resistant high carbon cutter edge standard
- HD Reinforcement Box Structures for increased durability
- 3/16" thick Grade 50 steel body
- Wear bars on the underside

MINI DIRT BUCKETS	ORDER CODE	SHIP WEIGHT (LBS)	LIST PRICE
<b>Standard Duty Mini Dirt Buckets</b>			
34.5" (5.8 ft <sup>3</sup> ) CII mount	233282	213	\$1,000
36" (6 ft <sup>3</sup> ) CII mount	233099	218	\$1,060
42" (7.3 ft <sup>3</sup> ) CII mount	233103	240	\$1,145
48" (8.3 ft <sup>3</sup> ) CII mount	233290	261	\$1,240
36" (6 ft <sup>3</sup> ) Bobcat mount	233284	222	\$1,060
42" (7.3 ft <sup>3</sup> ) Bobcat mount	233101	249	\$1,145
48" (8.3 ft <sup>3</sup> ) Bobcat mount	233288	269	\$1,240
<b>Heavy Duty Mini Dirt Buckets</b>			
48" (9.3 ft <sup>3</sup> ) SSL mount	233110	303	\$1,360
54" (10.5 ft <sup>3</sup> ) SSL mount	233115	325	\$1,450
60" (11.8 ft <sup>3</sup> ) SSL mount	233123	346	\$1,540
48" (9.3 ft <sup>3</sup> ) CII mount	233263	267	\$1,360
54" (10.5 ft <sup>3</sup> ) CII mount	233111	289	\$1,450
60" (11.8 ft <sup>3</sup> ) CII mount	233119	311	\$1,540

OPTIONS	ORDER CODE	SHIP WEIGHT (LBS)	LIST PRICE
34.5" bolt on edge	233093		\$160
36" bolt on edge	107156		\$158
42" bolt on edge	107157		\$175
48" bolt on edge	107158		\$180
54" bolt on edge	233268		\$261
60" bolt on edge	233269		\$291
34.5" bolt on tooth bar kit	119492		\$518
36" bolt on tooth bar kit	120712		\$565
42" bolt on tooth bar kit	2001065		\$601
48" bolt on tooth bar kit	18200		\$609
54" bolt on tooth bar kit	124965		\$738
60" bolt on tooth bar kit	236346		\$738
34.5" bolt on tooth kit (4 required)	233266		\$15
36" bolt on tooth kit (4 required)	233266		\$15
42" bolt on tooth kit (5 required)	233266		\$15
48" bolt on tooth kit (5 required)	233266		\$15
54" bolt on tooth kit (6 required)	233266		\$15
60" bolt on tooth kit (7 required)	233266		\$15



## MINI ATTACHMENTS FOR COMPACT TOOL CARRIERS AND MINI SKID-STEER LOADERS

**NEW PRODUCT**

### MINI LIGHT MATERIAL BUCKETS



HEAVY DUTY

Carrier Specifications
Lift Capacity
Light Duty - 750 lbs.
Standard Duty - 1500 lbs.
Heavy Duty - 2500 lbs.

- Optional Bolt on Edge and Teeth
- Wear resistant high carbon cutter edge standard
- HD Reinforcement Box Structures for increased durability
- 3/16" thick Grade 50 steel body
- Wear bars on the underside

MINI LIGHT MATERIAL BUCKETS	ORDER CODE	SHIP WEIGHT (LBS)	LIST PRICE
<b>Light Duty Light Material Buckets</b>			
34.5" (3.5 ft <sup>3</sup> ) CII mount	18741	172	\$880
36" (4 ft <sup>3</sup> ) CII mount	117506	175	\$879
42" (4 ft <sup>3</sup> ) CII mount	2000872	192	\$879
48" (6 ft <sup>3</sup> ) CII mount	2000877	240	\$1,070
<b>Standard Duty Light Material Buckets</b>			
36" (11.4 ft <sup>3</sup> ) CII mount	233151	244	\$1,110
42" (13.5 ft <sup>3</sup> ) CII mount	233148	269	\$1,195
48" (15.6 ft <sup>3</sup> ) CII mount	233157	293	\$1,325
36" (11.4 ft <sup>3</sup> ) Bobcat mount	233159	273	\$1,110
42" (13.5 ft <sup>3</sup> ) Bobcat mount	233161	303	\$1,165
48" (15.6 ft <sup>3</sup> ) Bobcat mount	233163	325	\$1,325
<b>Heavy Duty Light Material Buckets</b>			
48" (15.6 ft <sup>3</sup> ) CII mount	233129	313	\$1,445
54" (17.6 ft <sup>3</sup> ) CII mount	233145	338	\$1,530
48" (15.6 ft <sup>3</sup> ) SSL mount	233165	350	\$1,445
54" (17.6 ft <sup>3</sup> ) SSL mount	236244	375	\$1,530
60" (23.3 ft <sup>3</sup> ) SSL mount	236245	435	\$1,620
68" (27.1 ft <sup>3</sup> ) SSL mount	236246	469	\$1,900



OPTIONS	ORDER CODE	SHIP WEIGHT (LBS)	LIST PRICE
36" bolt on edge	107156		\$158
42" bolt on edge	107157		\$175
48" bolt on edge	107158		\$180
54" bolt on edge	233268		\$261
60" bolt on edge	233269		\$291
68" bolt on edge	233281		POR
36" bolt on tooth (4 required)	233266		\$15
42" bolt on tooth (5 required)	233266		\$15
48" bolt on tooth (5 required)	233266		\$15
54" bolt on tooth (6 required)	233266		\$15
60" bolt on tooth (7 required)	233266		\$15
68" bolt on tooth kit (8 required)	233266		\$15

# MINI ATTACHMENTS

## MINI ATTACHMENTS FOR COMPACT TOOL CARRIERS AND MINI SKID-STEER LOADERS

### MINI 4-IN-1 MULTI-PURPOSE BUCKET



<b>Carrier Specifications</b>
<b>Lift Capacity</b>
2500 lbs.

- Dual hydraulic cylinders
- High dump, dozer blade, grapple, general purpose bucket
- High carbon steel front cutting edge

MINI 4-IN-1 MULTI-PURPOSE BUCKET Includes mounting brackets (specify) and hoses	ORDER CODE	SHIP WEIGHT (LBS)	LIST PRICE
<b>Standard Duty Mini Multi-Purpose (4-in-1) Bucket</b>			
42" (5.5 ft <sup>3</sup> ) CII mount	2008270	250	\$2,350
48" (6.6 ft <sup>3</sup> ) CII mount	233333	281	\$2,550
<b>Heavy Duty Mini Multi-Purpose (4-in-1) Bucket</b>			
54" (8.8 ft <sup>3</sup> ) CII mount	233450	313	\$2,750
54" (8.8 ft <sup>3</sup> ) Bobcat mount	233351	354	\$2,750
60" (12.8 ft <sup>3</sup> ) SSL mount	111470	450	\$4,500



### MINI ROCK BUCKET



<b>Carrier Specifications</b>
<b>Lift Capacity</b>
1500 lbs.

- 1.125" or .75" tine diameter available
- Allows dirt to be sifted removing rocks, bricks, & foreign materials
- Can be used for back dragging & much more
- High strength alloy steel tines

MINI ROCK BUCKET	ORDER CODE	SHIP WEIGHT (LBS)	LIST PRICE
42" .75" tine CII mount	19695	138	\$2,082
42" 1.13" tine CII mount	19500	184	\$1,612
48" 1.13" tine CII mount	118191	207	\$1,612



## MINI ATTACHMENTS FOR COMPACT TOOL CARRIERS AND MINI SKID-STEER LOADERS

### MINI DOZER BLADE



- 30° left and right angle
- 6 way blade requires dual remotes or hydraulic kit
- Replaceable wear edge
- 6° left and right tilt



MINI DOZER BLADE	ORDER CODE	SHIP WEIGHT (LBS)	LIST PRICE
<b>Mini Angle Blades (includes hydraulic kit)</b>			
47" CII mount, poppet couplers	2004358	257	\$2,430
47" CII mount, flat face couplers	2008100	257	\$2,429
47" Bobcat MT 50/52, flat face couplers	102418	190	\$2,455
67" CII mount, poppet couplers	101776	310	\$3,014
67" CII mount, flat face couplers	101777	310	\$3,014
<b>Mini Angle/Tilt Blades (select from one group 1, 2, or 3)</b>			
47" Bobcat MT 50/52	18989	265	\$2,859
47" Universal mount, no hoses	18999	257	\$3,065
67" Universal mount, no hoses	102292	299	\$3,353

OPTIONS CHOOSE FROM ONE GROUP 1, 2, OR 3	ORDER CODE	SHIP WEIGHT (LBS)	LIST PRICE
<b>Group 1</b>			
dual remote, flat face couplers	19235	30	\$406
dual remote, poppet couplers	100598	30	\$375
<b>Group 2</b>			
manual hydraulic valve, flat face couplers	19219	40	\$816
manual hydraulic valve, poppet couplers	19230	40	\$920
<b>Group 3</b>			
hydraulic/electric valve, flat face couplers	19577	50	\$1,316
hydraulic/electric valve, poppet couplers	100539	50	\$1,948

OPTIONS	ORDER CODE	SHIP WEIGHT (LBS)	LIST PRICE
47" bolt on edge	2005076		\$106
67" bolt on edge	101460		\$116

# MINI ATTACHMENTS

## MINI ATTACHMENTS FOR COMPACT TOOL CARRIERS AND MINI SKID-STEER LOADERS

### MINI GRAPPLES

#### MINI BRUSH GRAPPLES

**NEW PRODUCT**



Carrier Specifications
Lift Capacity
2500 lbs.

- 42", 48", or 54" widths available
- Hydraulic grapple with guarded cylinder
- 1,500 to 3,000 operating pressure (psi)
- High strength grade 50 steel throughout

MINI BRUSH GRAPPLE	ORDER CODE	SHIP WEIGHT (LBS)	LIST PRICE
42" CII mount	235962	256	\$2,470
48" CII mount	235965	275	\$2,740
54" CII mount	235967	283	\$2,740
42" Bobcat mount	235963	299	\$2,470
48" Bobcat mount	235964	318	\$2,740
54" Bobcat mount	235966	326	\$2,740
48" SSL mount	235902	318	\$2,740
54" SSL mount	235904	325	\$2,740



### MINI ROOT GRAPPLES

**NEW PRODUCT**



Carrier Specifications
Lift Capacity
2500 lbs.

- Brush guard cylinder protection
- AR400 bucket tine construction
- High strength steel throughout
- 1,500 to 3,000 operating pressure (psi)

MINI BRUSH GRAPPLE	ORDER CODE	SHIP WEIGHT (LBS)	LIST PRICE
42" CII mount	124429	268	\$2,660
48" CII mount	235928	276	\$3,050
53" CII mount	124412	282	\$3,400
42" Bobcat mount	124429-0128	217	\$2,660
48" Bobcat mount	235930	225	\$3,050
53" Bobcat mount	235842	227	\$3,400
48" SSL mount	235917	264	\$3,050
54" SSL mount	235845	270	\$3,400



# MINI ATTACHMENTS

## MINI ATTACHMENTS FOR COMPACT TOOL CARRIERS AND MINI SKID-STEER LOADERS

### MINI SCRAP GRAPPLES

**NEW PRODUCT**



Carrier Specifications
Lift Capacity
2500 lbs.

- 36", 42", or 48" widths available
- Hydraulic grapple

MINI SCRAP GRAPPLE	ORDER CODE	SHIP WEIGHT (LBS)	LIST PRICE
36" CII mount	107147	281	\$2,450
42" CII mount	235913	300	\$2,560
48" CII mount	235907	329	\$2,750
54" CII mount	235870	349	\$2,900
36" Bobcat mount	235877	316	\$2,450
42" Bobcat mount	235916	340	\$2,560
48" Bobcat mount	235894	368	\$2,750
54" Bobcat mount	235883	388	\$2,900
48" SSL mount	235882	366	\$2,750
54" SSL mount	235871	385	\$2,900

OPTIONS	ORDER CODE	SHIP WEIGHT (LBS)	LIST PRICE
36" bolt on edge	107156		\$158
42" bolt on edge	107157		\$175
48" bolt on edge	107158		\$180
54" bolt on edge	233268		\$261



Add Surcharge to all products 8.85%

# MINI ATTACHMENTS

## MINI ATTACHMENTS FOR COMPACT TOOL CARRIERS AND MINI SKID-STEER LOADERS

### LEVELER



- Grades and backfills rough ground
- Carrying platform for brush, trees, blocks, etc.

LEVELER	ORDER CODE	SHIP WEIGHT (LBS)	LIST PRICE
48" CII mount	2000857	135	\$955



### MINI POWER SHOVEL



- Pick your own mount
- No hydraulics or electrical required
- Great for removing & transplanting shrubs, bushes, & small trees

MINI POWER SHOVEL	ORDER CODE	SHIP WEIGHT (LBS)	LIST PRICE
CII mount	2000867	165	\$975
Bobcat mount	125437	165	\$1,347



Add Surcharge to all products 8.85%

## MINI ATTACHMENTS FOR COMPACT TOOL CARRIERS AND MINI SKID-STEER LOADERS

### MINI PALLET FORKS



- Spill guard
- 36", 42" & 48" fork tine lengths
- Adjustable width

MINI PALLET FORKS	ORDER CODE	SHIP WEIGHT (LBS)	LIST PRICE
<b>Standard Duty Pin-Mount Frame</b>			
30" CII mount	233247	162	\$575
30" Bobcat mount	233248	183	\$780
<b>Standard Duty Pin-Mount Tines - 1500 lbs Rated Operating Capacity</b>			
1.18" x 3.15" x 32" (Pair)	13653		\$280
1.18" x 3.15" x 42" (Pair)	13654		\$360
<b>Heavy Duty ITA Mount Frame</b>			
40" CII mount	123311	210	\$590
40" Bobcat mount	233250	223	\$800
<b>Heavy Duty ITA Mount Tines - 2500 lbs Rated Operating Capacity</b>			
1.38" x 4" x 42" (Pair)	102028		\$409
1.38" x 4" x 48" (Pair)	102030		\$425



### MINI POWER BOX RAKE



- Direct drive motor is embedded within frame and drum providing optimal protection from dirt and debris
- Adjustable barrier crafted from eco-friendly recycled aircraft rubber
- Specially shaped and placed carbide teeth ensure the best possible seedbed
- Easily removable endplates
- Dual independently adjustable gauge wheels
- Multi-position gates

MINI POWER BOX RAKE	ORDER CODE	SHIP WEIGHT (LBS)	LIST PRICE
D4M - Manual Angle CII mount	22748M-0961	365	\$9,307
D4M - Manual Angle Bobcat mount	22748M-0128	365	\$9,987
D4H - Hydraulic Angle CII mount	22748H-0961	380	\$11,387
D4H - Hydraulic Angle Bobcat mount	22748H-0128	380	\$12,220



# MINI ATTACHMENTS

## MINI ATTACHMENTS FOR COMPACT TOOL CARRIERS AND MINI SKID-STEER LOADERS

### MINI SKID/SWING HOES



- Fixed or swing configurations available
- Bucket curl feature
- 8", 10", & 12" buckets available

MINI SKID/SWING HOE	ORDER CODE	SHIP WEIGHT (LBS)	LIST PRICE
<b>Fixed Skid Hoe</b>			
universal mount, poppet couplers	89192	166	\$1,942
universal mount, flat face couplers	89349	165	\$1,942
ASV RC30 / Polaris	111131	150	\$2,250
Bobcat MT50/52	18759	155	\$2,177
<b>Swing Skid Hoe</b>			
universal mount, no hoses	100853	250	\$3,323
Bobcat MT50-52, no hose or valve	118234	325	\$4,102
ASV/Polaris, no hose or valve	122233	338	\$3,048
<b>Bucket widths</b>			
8" standard (2 teeth)	88508	40	\$612
10" standard (3 teeth)	88510	43	\$630
12" standard (3 teeth)	88512	58	\$679
<b>Options for Swing Hoe</b>			
hydraulic kit, dual remote, flat face couplers	102488	10	\$643
hydraulic kit, dual remote, poppet couplers	102489	10	\$340
hydraulic kit, hydraulic valve, flat face couplers	102490	15	\$1,775
hydraulic kit, hydraulic valve, poppet couplers	102491	15	\$1,423
hydraulic kit, hydraulic/electric valve, flat face couplers	102492	20	\$1,793
hydraulic kit, hydraulic/electric valve, poppet couplers	102493	20	\$1,700



### MINI SNOW BLADE



- Hydraulically or manually angles 30° in either direction
- Reversible, replaceable wear edge, optional rubber edge
- Adjustable skid shoes
- Spring-loaded trip mechanism
- 7-gauge steel blade

MINI SNOW BLADE - 114 SERIES	ORDER CODE	SHIP WEIGHT (LBS)	LIST PRICE
48" manual angle snow blade** CII mount	11448M-0961	420	\$3,428
48" hydraulic angle snow blade** CII mount	11448-0961	425	\$4,559
48" hydraulic angle snow blade** ASV/Polaris mount	11448-0002	437	\$4,559
48" hydraulic angle snow blade** Bobcat mount	11448-0128	460	\$3,775

\*\*Denote desired angle type when ordering



## MINI ATTACHMENTS FOR COMPACT TOOL CARRIERS AND MINI SKID-STEER LOADERS

### MINI SNOW BLADE CONT.

MOUNTING			
Contact Customer Service at (833) 723-1843			
OPTIONS - REPLACEMENT PARTS	ORDER CODE	SHIP WEIGHT (LBS)	LIST PRICE
<b>Optional Edge Kits</b>			
Rubber edge kit	118937	150	\$757
Steel edge kit	118936	50	\$245
<b>Angle Kits</b>			
Manual Angle Kit	FFC10014	NA	POR
Hydraulic Angle Kit	FFC10049	NA	POR

### MINI SNOW BLOWER



- The new 3D floating hitch offers side to side, up and down, and front to back motion to allow the snow blower to have the smoothest operating experience when working on uneven surfaces
- The 3D floating hitch also allows for an uninterrupted scrape offering a cleaner surface which means less salt is required
- The dual articulating chute offering unprecedented user control on where to place the snow with the 270 degrees of motion and ability to blow snow from as close as 3 feet or up to 45 feet
- The skid skis offer toolless adjustment which enable users to quickly and easily transition from gravel to pavement

Specifications - Mini Snow Blower									
Model #	Weight	Cutting Width	Cutting Height	Overall Length	Min Overall Height	Max Overall Height	Auger Dia.	Flow	Hydraulic Pressure
25048B-0961	820 lbs	48"	27.5"	46"	60"	71"	15"	8-15 GPM	3500 PSI

STANDARD FLOW SNOW BLOWER	ORDER CODE	SHIP WEIGHT (LBS)	LIST PRICE
48" Standard-Flow Snow Blower CII mount	25048B-0961	820	\$10,566



REPLACEMENT PARTS	ORDER CODE	SHIP WEIGHT (LBS)	LIST PRICE
Steel Edge Kit	28-11300-48		\$115
Polyurethane Edge Kit	28-11301-48		\$437
Steel Wear Shoe Kit	28-11312		\$230
Soft Wear Shoe Kit	28-11313		\$412
Kit Service Supply/Return Hoses/Ftgs SF/LF	28-11342		POR
Kit Service QD 1/2" ISO 16028 (1 M & 1 F)	28-9570		\$151
Kit Service Chute Rotation Motor	28-11302		\$787
Kit Service Impeller LF Motor (Motor & Hardware)	28-11305		POR
Kit Service Auger LF Motor (Motor & Hardware)	28-11308		POR
Kit Seal Impeller/Auger Motor (Motor & Hardware)	LAF4572-0000		\$221

# MINI ATTACHMENTS

## MINI ATTACHMENTS FOR COMPACT TOOL CARRIERS AND MINI SKID-STEER LOADERS

### MINI STUMP GRINDER



- Ball bearing mounted cutting wheel provides smooth, trouble free operation
- Adjustable wheel cutting angle allows optimal cutting for any type of stump
- Two motor size options

MINI STUMP GRINDER			
	ORDER CODE	SHIP WEIGHT (LBS)	LIST PRICE
8 to 11 GPM does not include mount, hoses, or wheel	101865	325	\$3,338
10 to 14 GPM does not include mount, hoses, or wheel	101866	325	\$3,364
MOUNTS - ONE REQUIRED			
	ORDER CODE	SHIP WEIGHT (LBS)	LIST PRICE
Universal mounting assembly	101868	67	\$837
ASV RC30 mounting assembly	104373	100	\$732
Bobcat MT50/52 mounting assembly	104374	100	\$956
C&P 027 mounting assembly	104375	113	\$1,226
Gehl mounting assembly	116575	65	\$732
HYDRAULIC KIT (ONE REQUIRED)			
	ORDER CODE	SHIP WEIGHT (LBS)	LIST PRICE
hose kit, flat face couplers	101874	15	\$365
hose kit, poppet couplers	101875	10	\$324
TEETH OPTIONS (ONE REQUIRED)			
	ORDER CODE	SHIP WEIGHT (LBS)	LIST PRICE
wheel assembly with bolt-on teeth	101876	32	\$1,589
wheel assembly with square teeth	101877	36	\$1,119
REPLACEMENT TEETH			
	ORDER CODE	SHIP WEIGHT (LBS)	LIST PRICE
tooth kit, bolt-on teeth	102198	23	\$1,127
tooth kit, square teeth	102199	10	\$611



## MINI ATTACHMENTS FOR COMPACT TOOL CARRIERS AND MINI SKID-STEER LOADERS

### MINI TILLER



- Replaceable and reversible tines
- Adjustable depth guide
- 8 to 15 GPM recommended
- 1,500 to 3,000 operating pressure (PSI)

MINI TILLER	ORDER CODE	SHIP WEIGHT (LBS)	LIST PRICE
40" CII mount, flat face couplers	2008000	320	\$5,264
40" CII mount, poppet couplers	2004807	320	\$3,929
48" CII mount, flat face couplers	104569	357	\$5,367



### MINI TREE FORK



- 33" length tines
- Up to 27" maximum hydraulic adjustable width
- Hydraulic controlled cylinder

MINI TREE FORK - HYDRAULIC	ORDER CODE	SHIP WEIGHT (LBS)	LIST PRICE
25" Tree Fork, CII mount, poppet couplers	2000382	145	\$1,758
25" Tree Fork, CII mount, flat face couplers	2008130	145	\$1,758



Add Surcharge to all products \$0.85%

# MINI ATTACHMENTS

## MINI ATTACHMENTS FOR COMPACT TOOL CARRIERS AND MINI SKID-STEER LOADERS

### MINI TRENCHER



- 2 motor options to match the flow of many skid-steer loaders
- Fixed length booms available featuring spring-loaded, self adjusting idler with full rock guards
- 50,000 lb 1.65" anti-back flex-chain for tooth pattern versatility to support many soil types and conditions

**!** *Note: 615 Trencher is limited to skid steers with up to 1,000 lb. lift capacity and maximum flow of 16 GPM.*

**i** **TO ORDER: CHOOSE TRENCHER ASSEMBLY, BOOM & CRUMBER ASSEMBLY, CHAIN & TEETH ASSEMBLY, MOUNT AND HYDRAULIC KIT**



COMPLETE 615 TRENCHER WITH BOOM & CHAIN/TEETH ASSEMBLIES (INCLUCES HOSES)-MUST ORDER COUPLERS	ORDER CODE	SHIP WEIGHT (LBS)	LIST PRICE
36" digging depth, 6" wide chain, 6-10 gpm, 70/30 tooth every station, fixed MTG	124901	525	\$7,674
36" digging depth, 6" wide chain, 10-16 gpm, tooth every station, fixed MTG	124902	518	\$7,341

TRENCHER ASSEMBLY	ORDER CODE	SHIP WEIGHT (LBS)	LIST PRICE
615 trencher assembly, 6-10 GPM	18392	274	\$4,168
615 trencher assembly, 10-16 GPM	18393	250	\$4,168

BOOM & CRUMBER ASSEMBLIES	ORDER CODE	SHIP WEIGHT (LBS)	LIST PRICE
24" digging depth (25 stations)	18401	115	\$1,080
30" digging depth (29 stations)	18402	123	\$1,212
36" digging depth (32 stations)	18403	159	\$1,146
48" digging depth (41 stations)	18404	168	\$1,502

CHAIN & TEETH ASSEMBLIES (MUST MATCH BOOM & CRUMBER SIZE)	ORDER CODE	SHIP WEIGHT (LBS)	LIST PRICE
<b>38,000# / 1.654 Pitch / Cut-Type Teeth / Tooth Every Station</b>			
for 24" boom 4.5" wide chain	16692	61	\$765
for 24" boom 6" wide chain	16691	66	\$819
for 24" boom 8" wide chain	16690	76	\$1,161
for 24" boom 10" wide chain	16689	82	\$1,343
for 24" boom 12" wide chain	16688	94	\$1,582
for 30" boom 4.5" wide chain	16687	70	\$1,215
for 30" boom 6" wide chain	16686	76	\$1,358
for 30" boom 8" wide chain	16685	88	\$1,555
for 30" boom 10" wide chain	16684	98	\$1,772
for 36" boom 4.5" wide chain	89822	76	\$1,366
for 36" boom 6" wide chain	89823	84	\$1,287
for 36" boom 8" wide chain	89824	96	\$1,551
for 48" boom 4" wide chain	18772	138	\$1,418
for 48" boom 6" wide chain	18773	154	\$1,820

## MINI ATTACHMENTS FOR COMPACT TOOL CARRIERS AND MINI SKID-STEER LOADERS MINI TRENCHER CONT.

CHAIN & TEETH ASSEMBLIES CONT. (MUST MATCH BOOM & CRUMBER SIZE)		ORDER CODE	SHIP WEIGHT (LBS)	LIST PRICE
<b>38,000# / 1.654 Pitch / 70/30 Combination / Shark-Type / Cup-Type Teeth / Tooth Every Station</b>				
for 24" boom 4.5" wide chain		119509	51	\$1,105
for 24" boom 6" wide chain		18763	65	\$1,143
for 24" boom 8" wide chain		18764	71	\$1,313
for 24" boom 10" wide chain		18765	78	\$1,509
for 24" boom 12" wide chain		18766	89	\$1,655
<b>38,000# / 1.654 Pitch / 70/30 Combination / Shark-Type / Cup-Type Teeth / Tooth Every Station</b>				
for 30" boom 6" wide chain		18767	76	\$1,584
for 30" boom 8" wide chain		18768	82	\$1,608
for 30" boom 10" wide chain		18769	90	\$1,784
for 36" boom 4.5" chain		89825	76	\$1,740
for 36" boom 6" wide chain		89826	83	\$1,620
for 36" boom 8" wide chain		89827	92	\$1,956
for 36" boom 10" wide chain		18777	99	\$1,910
for 36" boom 12" wide chain		18778	113	\$2,120
for 48" boom 4.5" wide chain		18770	142	\$1,757
for 48" boom 6" wide chain		18771	153	\$2,120
MOUNTING KITS		ORDER CODE	SHIP WEIGHT (LBS)	LIST PRICE
mini-loader, universal		89952	46	\$388
mini-loader, universal offset		15495	56	\$627
John Deere 35D		113988	40	\$826
John Deere 50D/50ZTS Coupler		116052	99	\$1,093
Polaris 300/ASV RC30		24305	77	\$908
* Includes Hydraulic Kit				
HYDRAULIC KITS		ORDER CODE	SHIP WEIGHT (LBS)	LIST PRICE
<b>Mini Loader</b>				
56" hose, poppet couplers		18559	20	\$208
56" hose, flat face couplers		18558	20	\$352
REPLACEMENT PARTS		ORDER CODE	SHIP WEIGHT (LBS)	LIST PRICE
Tooth Left 1.654 - Cup Style		31595		\$11
Tooth Right 1.654 - Cup Style		31596		\$11
Tooth Center 1.654 - Shark Style		31592		\$28
Tooth Left 1.654 - Shark Style		31593		\$34
Tooth Right 1.654 - Shark Style		31594		\$34

# MINI ATTACHMENTS

## MINI ATTACHMENTS FOR COMPACT TOOL CARRIERS AND MINI SKID-STEER LOADERS

### MINI VIBRATORY PLOW



- 12' turning radius
- Rotating coulter wheel frame mounted
- Optional hydraulic steering assembly
- Optional cable chute blades, reel mount, and pulling accessories available



**TO ORDER: CHOOSE PLOW ASSEMBLY, HYDRAULIC KIT, MOUNT AND BLADE**

MINI VIBRATORY PLOW ASSEMBLY	ORDER CODE	SHIP WEIGHT (LBS)	LIST PRICE
VP10 Mini Vib Plow 8 to 11 GPM	19733	467	\$11,851
VP10 Mini Vib Plow 10 to 14 GPM	19734	467	\$12,696

MINI VIBRATORY PLOW HYDRAULIC KIT (ONE REQUIRED)	ORDER CODE	SHIP WEIGHT (LBS)	LIST PRICE
without steering, .50" poppet couplers	19380	10	\$343
without steering, .50" flat face couplers	19381	10	\$596
with steering, .50" poppet couplers *	19382	25	\$776
with steering, .50" flat face couplers*	19383	25	\$1,284

\*Skid-Steer must have two sets of auxiliary hydraulics

MINI VIBRATORY PLOW MOUNTING KITS (ONE REQUIRED)	ORDER CODE	SHIP WEIGHT (LBS)	LIST PRICE
universal mounting	19384	45	\$564
3-point category I mounting kit	101827	45	\$1,112
ASV/Polaris mounting kit	19389	45	\$790
Bobcat MT50/MT100 mounting	102012	86	\$886

MINI VIBRATORY PLOW BLADES (ONE REQUIRED)	ORDER CODE	SHIP WEIGHT (LBS)	LIST PRICE
<b>.375" (3/8") Wide Blade</b>			
.375" blade 20°, 1" clevis, 6" to 12" depth	19325	25	\$382
.375" blade 30°, 1" clevis, 6" to 12" depth	19441	20	\$480
.375" blade 20°, 1" clevis, 12" to 18" depth	18690	25	\$343
.375" blade 30°, 1" clevis, 12" to 18" depth	2007030	25	\$489
<b>.50" (1/2") Wide Chute Blade</b>			
.50" chute blade 20°, 6" to 12" depth	19442	40	\$497
.50" chute blade 30°, 6" to 12" depth	19443	40	\$640
.50" chute blade 20°, 12" to 18" depth	19444	45	\$499
.50" chute blade 30°, 12" to 18" depth	19445	45	\$565
.50" chute blade 20°, 20" to 24" depth	109214	31	\$433
.50" chute blade 30°, 18" to 24" depth	112256	53	\$751

MINI VIBRATORY PLOW CONTINUED NEXT PAGE

## MINI ATTACHMENTS FOR COMPACT TOOL CARRIERS AND MINI SKID-STEER LOADERS

### MINI VIBRATORY PLOW CONT.

OPTIONS	ORDER CODE	SHIP WEIGHT (LBS)	LIST PRICE
pull bullet assembly, 2.5" dia	17754	5	\$158
cable pull grip, 1" to 1.24" cable	2001171	3	\$818
cable pull grip, .75" to .99" dia.	100435	3	\$766
cable pull grip, 1.25" to 1.49" dia.	100436	3	\$719
pipe bullet assembly, 1" to 1.5" pipe	18740	5	\$797
cable reel mount, 24" max. dia. reel	19085	26	\$684
steering conversion kit, .50" poppet couplers	19732	20	\$594
steering conversion kit, .50" flat face couplers	19735	20	\$712

### MINI VIBRATORY ROLLER



- 36" smooth drum

Specifications											
Model #	Overall Width	Drum Width	Overall Height	Overall Length	Drum Diameter	Operating Weight (lbs)	Dynamic Force (lbs)	Vibrating Speed (vpm)	Vibrating Weight (lbs)	Drum Oscillation/Tile	Hydraulic Motor Flow (gpm)
109100	41.47"	36"	21.5"	34.4"	20"	840	2488	2000	507	15°	6-9
109101	41.47"	36"	21.5"	34.4"	20"	840	2488	2000	507	15°	10-14

	ORDER CODE	SHIP WEIGHT (LBS)	LIST PRICE
<b>Smooth Drum</b>			
36" smooth drum (6 to 9 gpm) CII mount	109100	840	\$10,434
36" smooth drum (10 to 14 gpm) CII mount	109101	840	\$11,198



# MINI ATTACHMENTS

## MINI ATTACHMENTS FOR COMPACT TOOL CARRIERS AND MINI SKID-STEER LOADERS

Add Surcharge to all products 8.85%

# MULCHERS



# MULCHERS

## MULCHERS, SERIES II



- 36", 42" and 72" cutting widths available
  - 36" and 42" excavators only
  - 60" Skid-steer only and excavator only
  - 72" Skid-steer only
- Shreds up to 12" diameter hardwood trees
- Tree stabilization guide improves handling of tall trees and slender saplings (MM36, MM421, MM422 models only; patent protected by US8316901)
- Reversible carbide teeth and claw teeth can easily be interchanged without the need of rebalancing the rotor
- Synchronous belt drive system eliminates belt and belt drive sprocket slippage
- Heavy duty bent axis variable displacement piston motor



### Specifications

Model	Prime Mover	Metric Ton	Weight*	Overall Width	Overall Height	Overall Length	Cutting Width	Operating Pressure	Hydraulic Flow (GPM)	Rec. Hydraulic HP	Number of Teeth
MM36E	Excavator	08-16	1580 lbs	48.5"	24.75"	33.03"	36"	3500-5000	28-41	40-65	26
MM36E	Excavator	08-16	1600 lbs	48.5"	24.75"	33.03"	36"	3500-5000	42-60	65-90	26
MM421E	Excavator	14-21	2505 lbs	58"	31.3"	34.3"	42"	4500-5800	29-39	55-95	30
MM422E	Excavator	20-30	2920 lbs	58.6"	33"	34.9"	42"	4500-5800	40-52	75-115	30
MM60S	Skid Steer	-	2530 lbs	73"	60.42"	49.5"	60"	3000-4000	30-45	60-95	44
MM60E	Excavator	-	2710 lbs	73"	-	-	60"	3000-5800	30-60	60-95	44
MM60C	Comb.**	-	2980 lbs	73"	68.87"	53.33"	60"	3000-5800	30-60	60-95	44
MM60H	Forestry	-	2550 lbs	73"	60.42"	49.5"	60"	4500-5800	35-45	90-130	44
MM601E	Excavator	16-25	2945 lbs	75.5"	31.3"	34.3"	60"	4500-5800	32-44	60-100	44
MM72S	Skid-Steer	-	2860 lbs	85"	60.42"	49.5"	72"	3500-5000	30-45	75-95	54
MM72H	Forestry	-	2880 lbs	85"	60.42"	49.5"	72"	4500-5800	30-45	90-130	54

\* Does not include weight of excavator mount for excavator models

\*\* Comb.: Excavator and Skid Steer



**Note: We highly recommend the purchase of guarding to protect operator and machine from flying debris in harsh forestry and land clearing environments. Please refer to the SSL Forestry Guarding section on page 190 for more information. For Skid-Steer loaders only.**



## MULCHERS FOR SKID-STEER LOADERS



**TO ORDER: Choose Mulcher Assembly, Hose Kit, and Tooth Set. Universal SSL Mount included unless otherwise specified.**

MULCHER ASSEMBLY	ORDER CODE	SHIP WEIGHT (LBS)	LIST PRICE
<b>60" cutting width (3 line)</b>			
MM60S Series II Mulcher	115622	2605	\$37,000
MM60C Series II Mulcher (requires combination mount from Excavator Mounts section)	115625	3005	\$40,000
MM60S Series II Mulcher Complete (Claw Teeth Included)	124171	2700	\$37,000
MM60S Series II Mulcher Complete (Reversible Claw Hammers Included)	125346	2700	\$44,000
<b>60" cutting width (5 line)</b>			
MM60S Series II Mulcher	115623	2605	\$38,000
MM60H Series II Mulcher	115626	2625	\$40,000

MULCHERS CONTINUED NEXT PAGE



## MULCHERS, SERIES II CONT.

### MULCHERS FOR SKID-STEER LOADERS CONT.

MULCHER ASSEMBLY CONT.	ORDER CODE	SHIP WEIGHT (LBS)	LIST PRICE
<b>72" cutting width (3 line)</b>			
MM72S Series II Mulcher	115630	2975	\$38,000
MM72S Series II Mulcher Complete (Claw Teeth Included)	124652	3070	\$42,000
MM72S Series II Mulcher Complete (Reversible Claw Hammers Included)	126008	3070	\$46,500
<b>72" cutting width (5 line)</b>			
MM72S Series II Mulcher	115631	2975	\$38,000
MM72H Series II Mulcher	115632	2975	\$40,000
HOSE KITS & COUPLERS	ORDER CODE	SHIP WEIGHT (LBS)	LIST PRICE
<b>Hose Kits (3 line)</b>			
65" hose kit, 4000 max psi	110914	1	\$484
80" hose kit, 4000 max psi	110915	1	\$934
96" hose kit, 4000 max psi	110916	1	\$716
<b>Hose Kits (5 line)</b>			
65" hose kit, 4000 max psi	114047	16	\$608
80" hose kit, 4000 max psi	114048	19	\$670
96" hose kit, 4000 max psi	114049	23	\$757
65" hose kit, 6000 max psi	116995	27	\$647
80" hose kit, 6000 max psi	116996	31	\$758
96" hose kit, 6000 max psi	116997	35	\$1,042
<b>Coupler Cross Reference *</b>			
select from individual couplers listed below (note: case drain coupler required)			
<b>Case Drain / Auxiliary Door Function #8 Boss O-Ring</b>			
.25" body male flat face coupler with adapter	111215	1	\$36
.25" body female flat face	115232	1	\$101
.38" body male	84923	1	\$37
.38" body female	84928	1	\$80
.50" body female	14175	2	\$93
.50" body male	14176	2	\$54
<b>Flat Face Quick Disconnect Coupler With No. 12 Boss O-Ring Main Power/Return</b>			
.50 body male	22519	2	\$55
.50 body female	22518	2	\$80
.625 body male	84922	3	\$140
.625 body female	84921	3	\$231
.75 body male	22521	3	\$263
.75 body female	22520	3	\$303
TOOTH SETS	ORDER CODE	SHIP WEIGHT (LBS)	LIST PRICE
<b>for 60" Mulcher</b>			
reversible carbide hammers (44 pieces)	116091	170	\$6,732
reversible claw teeth (44 pieces)	116092	170	\$2,574
<b>for 72" Mulcher</b>			
reversible carbide hammers (54 pieces)	111794	200	\$8,262
reversible claw teeth (54 pieces)	112578	200	\$3,159



Reversible Carbide Tooth



Reversible Claw Tooth

TOOTH SETS CONTINUED NEXT PAGE

# MULCHERS

## MULCHERS, SERIES II CONT.

### MULCHERS FOR SKID-STEER LOADERS CONT.



MULCHERS

TOOTH SETS CONT.	ORDER CODE	SHIP WEIGHT (LBS)	LIST PRICE
<b>Replacement Tooth Sets</b>			
reversible carbide hammer (includes 1 hammer)	600-168	4	\$228
reversible claw tooth	111588	4	\$92
<b>Bolts</b>			
bolt M16X 110	700-111	1	\$6
bolt M16X 75	700-114	1	\$6
lock washer special	10165	1	\$4

REPLACEMENT PARTS	ORDER CODE	SHIP WEIGHT (LBS)	LIST PRICE
Belt, Synchronous, Gates Poly Chain GT	113762		\$1,720
Skid Shoe - Right Weldment	115777		\$531
Skid Shoe - Left Weldment	115778		\$478

OPTIONS	ORDER CODE	SHIP WEIGHT (LBS)	LIST PRICE
<b>Deflector Door Assembly</b>			
For MM60E Series II only	116550	105	\$730
<b>Case Drain Relief Valve</b>			
For MM36 Series II only	116930	5	\$432
For MM60 Series II only	116931	7	\$417
For MM72 Series II only	116932	7	\$417
<b>Oil Coolers for Series II Mulchers only</b>			
For MM60 Series II Factory Installed	115851	110	\$5,002
For MM60 Series II Dealer Installed	115852	140	\$5,054
For MM72 Series II Factory Installed	115853	115	\$5,017
For MM72 Series II Dealer Installed	115854	145	\$6,082
<b>Oil Coolers (600 PSI Rated) For Non Series II Mulchers only</b>			
For 60" Mulcher Factory Installed	ew	80	POR
For 60" Mulcher Dealer Installed	114018	80	\$4,835
Convert from 5 line to 3 line coupler system	107651	15	\$637
Must choose electrical control box OR adapter harness for in-cab controls to operate door			LIST PRICE
<b>Electrical Control Box</b>			
Control box w/ power lead	28-10754	5	\$383
<b>Adapter Harness for In-Cab Control</b>			
Wire Harness (multi function in cab controls) for CNH, JCB, Bobcat, Mustang, Kubota, Takeuchi, Volvo 14 Pin-8 Pin	LAF9360-0000	5	\$268
Wire Harness Adapter John Deere EH OEM SSL	07-7626	5	\$711
Harness Adapter F/CAT XPS D 14 Pin-8 Pin	119740	5	\$770
Harness Adapter F/CAT XHP D 14 Pin-8 Pin	119741	5	\$784
Wire Harness Adapter CAT B&C Series SSL Hi Flow	07-10170	5	\$553
Wire Harness Adapter Komatsu SSL	07-10057	3	\$585
Wire Harness Adapter F/JD SSL	LAF9361	5	\$362
7-pin for Bobcat	07-9548	5	\$985



## MULCHERS, SERIES II CONT. MULCHERS FOR SKID-STEER LOADERS CONT.

### SSL GUARDING PACKAGES



*Note: We highly recommend the purchase of guarding to protect operator and machine from flying debris in harsh forestry and land clearing environments. For Skid-Steer loaders only.*

### KUBOTA GUARDING PACKAGE

	ORDER CODE	SHIP WEIGHT (LBS)	LIST PRICE
<b>Model SVL95-2</b>			
Complete Package: Top Guard, Working Light, Rear Grille Guard and Hyd Connection	WF8CFSVL2001		POR
Top Guard Kit, KU SVL Series	WF8290000		POR
Working Light Kit (FR/RR)	WF8290020		POR
Rear Grille Guard. KU SVL95-2	WF8290010		POR
Hydraulic Connection Guard Kit	WF8290030		POR
<b>SSL SVL95-2s</b>			
Def Cover, Kit, KU, SVL95-2S	WF8190000		POR
<b>Kubota Excavator Cab Guarding</b>			
Front Window Guard - Wire, KA KXX080-4, Enclosed Cab	WF1290060		POR

Add Surcharge to all products 8.85%

# MULCHERS

## MULCHERS, SERIES II CONT. FORESTRY GUARDING PACKAGES CONT.



### HYDRAULIC CONNECTION GUARDS

Heavy-duty formed 3/16" steel plate. Easy bolt-on installation – no welding. Complete Connect Under Pressure (CUP) manifold protection. Hinged guards for CUP manifold access.



### REAR BUMPER

Heavy-duty formed steel plate construction. Bolt-on design requires no welding. Does not interfere with OEM tie-down hook access or compartment doors. Departure angle of 21°



### REAR GRILL GUARD

Attaches to heavy duty rear bumper. Upper mounts weld to frame. Heavy-duty design protects radiator from debris while allowing ample airflow. Swings open to allow unhindered access to engine compartment.



### SWEEP

Protects rear of machine from falling debris. Tool-less opening from the inside and out and hinges up for emergency egress.



### TOP GUARD WITH LIGHT GUARDS

Supported by cab frame and held in place using existing rivnuts. Maintains top window visibility. Low profile design to avoid tree limbs. Includes light guards.



### INTAKE SCREENS

Filters debris from entering air cooler area. Helps prevent overheating issues and prolongs life of coolers. Bolt-on (hole modification required), no welding required. Replaceable steel mesh screen design.



### SIDE SCREENS

Heavy duty design to protect cab glass. Replaces OEM side screens for use in harsh environments.

## CASE FORESTRY GUARDING PACKAGES

	ORDER CODE	SHIP WEIGHT (LBS)
<b>CaseSV300, SV340 &amp; TV380 Tier 4B</b>		
Hydraulic connection guards, FG	W28190000	POR
Assembly, rear bumper, SSL, FG	W28190010	POR
Rear grill guard, CS SSL/CTL T4F, FG	W28190060	POR
Sweep kit, CS CTL/SSL, 90HP T4F, FG	W28190070	POR
Top guard w/ light guards, FG	W28190040	POR
Additional intake screens, SV300, FG	W28190050	POR
Side screen kit, CS SSL/CTL T4F, FG	W28290000	POR

## MULCHERS, SERIES II CONT. MULCHERS FOR EXCAVATORS



TO ORDER: CHOOSE MULCHER ASSEMBLY, EXCAVATOR MOUNT, AND TOOTH SET.

MULCHER ASSEMBLY	ORDER CODE	SHIP WEIGHT (LBS)	LIST PRICE
<b>36" cutting width</b>			
MM36E Series II Mulcher 28-41 gpm	115620	1620	\$25,000
MM36E Series II Mulcher 42-60 gpm	115621	1620	\$27,000
<b>42" cutting width</b>			
MM421E Series II Mulcher 29-39 gpm	31442-0000	2605	\$35,000
MM422E Series II Mulcher 40-52 gpm	30742-0000	2920	\$42,000
<b>60" cutting width</b>			
MM601 Series II Mulcher 32-44 gpm	31260-0000	3045	\$43,000
MM60E Series II Mulcher	115624	2785	\$40,000
MM60C Series II Mulcher (combination mount required from Mounts)	115625	3005	\$40,000

TOOTH SETS	ORDER CODE	SHIP WEIGHT (LBS)	LIST PRICE
<b>for 36" Mulcher</b>			
reversible carbide hammers (26 pieces)	116088	110	\$3,978
reversible claw teeth (26 pieces)	116089	110	\$1,521
<b>For 42" Mulcher</b>			
Reversible carbide hammers (30 pieces)	120051	127	\$5,367
Reversible claw teeth (30 pieces)	120052	127	\$2,347
<b>for 60" Mulcher</b>			
reversible carbide hammers (44 pieces)	116091	170	\$6,732
reversible claw teeth (44 pieces)	116092	170	\$2,574
<b>Replacement Tooth Sets</b>			
reversible carbide hammer (includes 1 hammer)	600-168	4	\$228
reversible claw tooth	111588	4	\$92
<b>Bolts</b>			
bolt M16X 110	700-111	1	\$6
bolt M16X 75	700-114	1	\$6
lock washer special	10165	1	\$4



Reversible Carbide Tooth



Reversible Claw Tooth

REPLACEMENT PARTS	ORDER CODE	SHIP WEIGHT (LBS)	LIST PRICE
<b>for 36" Mulcher</b>			
Belt, Synchronous, Gates Poly Chain GT	113762		\$1,720
Skid Shoe - Right Weldment	115649		\$440
Skid Shoe - Left Weldment	115650		\$440

REPLACEMENT PARTS CONTINUED NEXT PAGE

# MULCHERS

## MULCHERS, SERIES II CONT.

### MULCHERS FOR EXCAVATORS CONT.



MULCHERS

REPLACEMENT PARTS	ORDER CODE	SHIP WEIGHT (LBS)	LIST PRICE
<b>For 42" Mulcher</b>			
Belt, Synchronous, Gates Poly Chain GT - MM421	113762		\$1,720
Belt, Synchronous, Gates Poly Chain GT - MM422	119595		\$1,639
Right Skid Shoe WMT - MM421 & MM601	119547		\$473
Left Skid Shoe WMT - MM421 & MM601	119548		\$473
Left Skid Shoe WMT - MM422	119529		POR
Right Skid Shoe WMT - MM422	119530		\$665
<b>for 60" Mulcher</b>			
Belt, Synchronous, Gates Poly Chain GT	113762		\$1,720
Right Skid Shoe WMT - MM421 & MM601	119547		\$473
Left Skid Shoe WMT - MM421 & MM601	119548		\$473
Skid Shoe - Right Weldment	115777		\$531
Skid Shoe - Left Weldment	115778		\$478

EXCAVATOR MOUNTS	ORDER CODE	SHIP WEIGHT (LBS)	LIST PRICE
<b>MM36E Series II Excavator Mounts - Contact Factory for Mounts Not Listed</b>			
Takechi TB175/180FR	113362	140	\$2,390
Takechi TB1140	113997	180	\$2,033
Kubota KX080 Quick Attach	113468	130	\$1,090
Kobelco SK 150CC Mark-IV / SK 160-Mark IV	114483	200	\$1,530
Kobelco SK 60 Mark IV / SK 70SR	115324	140	\$1,090
Bobcat 442	114107	160	\$2,390
CAT 307 /308	114588	130	\$1,090
CAT 311 /312CL /313 /314	114784	185	\$1,405
JCB JS130	114290	180	\$2,054
JCB JS 160	114304	240	\$2,033
JCB JS 70 / JZ 70	114521	145	\$1,017
JCB 214E / 214S / 215E / 215S	115573	180	\$1,031
John Deere 200C LC/225C LC	114129	240	\$1,504
John Deere 110D / 120D / 130 LC / 135 C RTS	113997	180	\$2,033
John Deere 160CLC / 590D / 590E / 595D	116019	240	\$2,159
Komatsu PC200-3,5,6 / PC210 / PC228USLC	115228	285	\$2,250
Case CX80	114521	145	\$1,017
Case CX130/CX135 / 19010 / 9010B	114290	180	\$2,054
Case CX160	114304	240	\$2,033
Case CX160 with thumb	118932	264	\$2,033
Case CX75 SR / CX80 / 9007 / 9007B	114521	145	\$1,017
Case 9030B	114330	295	\$2,033
Cat 318CL / 318CLN / 320 B-Link	116663	245	\$1,966
Hitachi EX 150	116019	240	\$2,159

EXCAVATOR MOUNTS CONTINUED NEXT PAGE

## MULCHERS, SERIES II CONT. MULCHERS FOR EXCAVATORS CONT.

EXCAVATOR MOUNTS CONT.	ORDER CODE	SHIP WEIGHT (LBS)	LIST PRICE
<b>MM36E Series II Excavator Mounts - Contact Factory for Mounts Not Listed</b>			
Hitachi EX200 / EX225	114129	240	\$1,504
Hitachi EX110 / EX110-5 / EX100-2,3,5 / EX120-2,3,5 / EX130 / ZX120	113997	180	\$2,033
John Deere 290D	117856	144	\$1,132
John Deere 200C LC / 225C LC / 200 DL, with thumb	118357	282	\$2,033
Kobelco SK 130-IV / SK135SR	115517	180	\$1,338
Kobelco SK 135 SR	115593	215	\$2,390
Komatsu PC 88MR-8	115091	135	\$1,132
Komatsu PC120-6 / PC128US-2 / PC138USLC-2 / PC158 / PC158US-2,6	115405	180	\$1,504
Komatsu PC150 / PC160LC-7 / PC180	115871	200	\$1,504
Link-Belt 2700Q / 160LX	114304	240	\$2,033
Link-Belt 135MSR / 130LX / 3650Q	114290	180	\$2,054
Link-Belt 75MSR / LS1600 CII / 1600Q / 80 MSR	114521	145	\$1,017
Volvo EC140 / ECR145C	117120	195	\$1,410
Volvo EC 150 with S6 Quick Attach	114567	190	\$1,017
Volvo EC 160 with S6 Quick Attach	118294	197	\$1,618
Yanmar VI075 / SV100 / Komatsu 88m	115091	135	\$1,132
Case CX145D W/TMB	124983	200	\$2,232
Cat M313	239068	198	\$2,390
Doosan DX140LC-5	121293	189	\$1,247
Doosan DX80Z	119889	126	\$2,390
Extreme Forest Machine	113409	240	\$2,390
Hyundai HW 140,(SEE NOTES)	125098	207	\$1,590
John Deere 75D-85D-G, PIN GRAB	120508	132	\$1,012
Takeuchi TB290 / TB370	122933	145	\$822
Volvo EC140/150 W/STEELWRIST S6 COUPLER	233086	182	\$726
Volvo EC160 S1	120565	424	\$4,040
Volvo EC88/ECR88	120304	151	\$1,048
Volvo EW180D,ROCKLAND PIN GRABBER	121344	200	\$1,465
Case CX210/220,MM36	121560	263	\$2,094
<b>MM60E Series II Excavator Mounts - Contact Factory for Mounts Not Listed</b>			
Case 9010B / CX130 / CX135	116006	220	\$1,475
Case 90301 / 9030B / CX210 / CX225	114330	295	\$2,033
Cat 322 (S-Link)	110405	300	\$2,406
Cat 311 / 312 / 313 /314	110597	250	\$2,205
Cat 315D	116986	231	\$2,204
Cat 320 CL	118472	355	\$2,390
Cat 325 / (C-Link) / 320 / 321 / CRL 330	111607	300	\$2,038
CWS HE250 with Quick Attach	117798	350	\$2,390
Doosan DX225	117662	295	\$2,064
Hill Eng Coupler R210 AL3	119338	335	\$2,390
Hitachi EX200 / EX225USR / ZX200 / ZX225	114778	295	\$2,189
Hyundai 200W-7 / R21066-7	111498	300	\$2,297

EXCAVATOR MOUNTS CONTINUED NEXT PAGE

# MULCHERS

## MULCHERS FOR EXCAVATORS CONT.

EXCAVATOR MOUNTS CONT.	ORDER CODE	SHIP WEIGHT (LBS)	LIST PRICE
<b>MM60E Series II Excavator Mounts - Contact Factory for Mounts Not Listed</b>			
JCB JS200 / JS220	114330	295	\$2,033
John Deere 200CLC /225 C RTS	114778	295	\$2,189
Kobelco SK 220 / LC Mark IV / SK 250LC	112526	320	\$2,390
Kobelco SK 150 / 160-IV	112613	252	\$2,205
Kobelco Sk 200LC IV / Sk 210 / SK 235SR	115319	280	\$2,241
Tigercaat 822	118897	395	\$2,390
Volvo S1 Coupler	118690	542	\$4,703
Volvo ECR235C	117675	295	\$2,064
Case CX210C/235C	123112	323	\$2,190
Cat 315D W/THUMB	124993	272	\$2,313
Doosan DX140LC-5	125000	225	\$2,204
John Deere 130G	120007	194	\$2,390
John Deere 270DLC	112755	335	\$2,244
Komatsu PC 138 USLC-8	112028	230	\$950
Sany SY235 W/THUMB	123585	373	\$2,603
Takeuchi TB2150	124987	220	\$1,789
Volvo ECR140 / ECR145	120227	200	\$2,390
Volvo EW180D PIN ON	123822	230	\$2,390
<b>MM421 Series II Excavator Mounts - Contact Factory for Mounts Not Listed</b>			
Case CX 135 MSR, P-P 385mm	121794-9010	259	\$2,304
Case CX 135C SR, P-P 355mm	121794-9011	255	\$1,931
Case CX 145C SR, P-P 385mm	121794-9010	259	\$2,304
Case CX 160/CX 160B/CX 160C/CX 160D, P-P 435mm	121794-9020	324	\$2,304
Case CX 210/CX 210B/CX 210C/CX 210D, P-P 450mm	121794-9030	327	\$2,390
Caterpillar 314C/314D/314E, P-P 407mm	121794-0311	262	\$2,304
Caterpillar 315B/315C/315D/315F, P-P 463mm	121794-0315	283	\$2,304
Caterpillar M315D, P-P 463mm	121794-0315	283	\$2,304
Caterpillar 316E/316F, P-P 463mm	121794-0315	283	\$2,304
Caterpillar M316D/M316F, P-P 463mm	121794-0315	283	\$2,304
Caterpillar 318B/318C, P-P 445mm	121794-0320	327	\$2,262
Caterpillar 318B/318C, P-P 485mm	121794-0322	332	\$2,390
Caterpillar 318E/318FC, P-P 463mm	121794-0315	283	\$2,304
Caterpillar M318C/M318D, P-P 445mm	121794-0320	327	\$2,262
Caterpillar M318C/M318D, P-P 485mm	121794-0322	332	\$2,390
Caterpillar M318F, P-P 463mm	121794-0315	283	\$2,304
Caterpillar 319D, P-P 445mm	121794-0320	327	\$2,262
Caterpillar 319D, P-P 485mm	121794-0322	332	\$2,390
Caterpillar 320/320B/320C/320D/320E/320F, P-P 445mm	121794-0320	327	\$2,262
Caterpillar 320/320B/320C/320D/320E/320F, P-P 485mm	121794-0322	332	\$2,390
Caterpillar M320F, P-P 445mm	121794-0320	327	\$2,262
Caterpillar M320F, P-P 485mm	121794-0322	332	\$2,390

EXCAVATOR MOUNTS CONTINUED NEXT PAGE

## MULCHERS FOR EXCAVATORS CONT.

EXCAVATOR MOUNTS CONT.	ORDER CODE	SHIP WEIGHT (LBS)	LIST PRICE
<b>MM421 Series II Excavator Mounts - Contact Factory for Mounts Not Listed</b>			
Doosan DX 140LC-3/DX 140LCR-3/DX 140LC-5/DX 140LCR-5, P-P 408mm	121794-3140	263	\$2,304
Doosan DX 140W-5, P-P 408mm	121794-3140	263	\$2,304
Doosan DX 180LC/DX 180LC-3/DX 180LC-5, P-P 464mm	121794-4220	338	\$2,304
Doosan DX 190W-3/DX 190W-5, P-P 464mm	121794-4220	338	\$2,304
Doosan DX 210W/DX 210W-5, P-P 464mm	121794-4220	338	\$2,304
Hitachi ZX 135US/ZX 135US-3/ZX 135US-5, P-P 362mm	121794-7120	256	\$2,304
Hitachi EX 160LC-5, P-P 391mm	121794-7150	316	\$2,304
Hitachi ZX 160LC/ZX 160LC-3/ZX 160LC-5, P-P 391mm	121794-7150	316	\$2,304
Hitachi ZX 180LC-5, P-P 472mm	121794-7201	331	\$2,304
Hitachi ZX 180W, P-P 472mm	121794-7201	331	\$2,304
Hitachi ZX 190W-3, P-P 472mm	121794-7201	331	\$2,304
Hitachi EX 200LC/EX 200LC-2/EX 200LC-3/EX 200LC-5, P-P 472mm	121794-7201	331	\$2,304
Hitachi ZX 200LC/ZX 200LC-3, P-P 472mm	121794-7201	331	\$2,304
Hitachi ZX 210LC-5, P-P 472mm	121794-7201	331	\$2,304
Hitachi ZX 210W, P-P 472mm	121794-7201	331	\$2,304
Hyundai HW 140, P-P 390mm	121794-1130	260	\$1,932
Hyundai HX 140L, P-P 390mm	121794-1130	260	\$1,932
Hyundai R 140LC-7/R 140LC-7A/R 140LC-9/R 140LC-9A, P-P 390mm	121794-1130	260	\$1,932
Hyundai R 140W-7/R 140W-7A/R 140W-9/R 140W-9A, P-P 390mm	121794-1130	260	\$1,932
Hyundai HX 145LCR, P-P 390mm	121794-1130	260	\$1,932
Hyundai R 145LCR-9/R 145LCR-9A, P-P 390mm	121794-1130	260	\$1,932
Hyundai HX 160L, P-P 410mm	121794-2180	275	\$2,390
Hyundai R 160LC-7/R 160LC-7A/R 160LC-9/R 160LC-9A, P-P 410mm	121794-2180	275	\$2,390
Hyundai R 170W-7/R 170W-7A/R 170W-9, P-P 410mm	121794-2180	275	\$2,390
Hyundai HW 180, P-P 410mm	121794-2180	275	\$2,390
Hyundai HX 180L, P-P 410mm	121794-2180	275	\$2,390
Hyundai R 180LC-7/R 180LC-7A/R 180LC-9/R 180LC-9A, P-P 410mm	121794-2180	275	\$2,390
Hyundai R 200W-7/R 200W-7A, P-P 460mm	121794-4201	337	\$2,390
Hyundai HW 210, P-P 460mm	121794-4201	337	\$2,390
Hyundai R 210LC-7/R 210LC-7A/R 210LC-9, P-P 460mm	121794-4201	337	\$2,390
Hyundai R 210W-9/R 210W-9A, P-P 460mm	121794-4201	337	\$2,390
JCB JZ 140, P-P 385mm	121794-9010	259	\$2,304
JCB JS 145, P-P 385mm	121794-9010	259	\$2,304
JCB JS 145W, P-P 385mm	121794-9010	259	\$2,304
JCB JS 160, P-P 435mm	121794-9020	324	\$2,304
JCB JS 160W, P-P 435mm	121794-9020	324	\$2,304
JCB JS 175W, P-P 435mm	121794-9020	324	\$2,304
JCB JS 180, P-P 435mm	121794-9020	324	\$2,304
JCB JS 190, P-P 435mm	121794-9020	324	\$2,304
JCB JS 200, P-P 450mm	121794-9030	327	\$2,390
JCB JS 210, P-P 450mm	121794-9030	327	\$2,390

EXCAVATOR MOUNTS CONTINUED NEXT PAGE

# MULCHERS

## MULCHERS FOR EXCAVATORS CONT.

EXCAVATOR MOUNTS CONT.	ORDER CODE	SHIP WEIGHT (LBS)	LIST PRICE
<b>MM421 Series II Excavator Mounts - Contact Factory for Mounts Not Listed</b>			
John Deere 135C/135D/135G, P-P 362mm	121794-7120	256	\$2,304
John Deere 160 LC/160C LC/160D LC/160G LC, P-P 391mm	121794-7150	316	\$2,304
John Deere 180G LC, P-P 472mm	121794-7201	331	\$2,304
John Deere 180C W, P-P 472mm	121794-7201	331	\$2,304
John Deere 190D W/190G W, P-P 472mm	121794-7201	331	\$2,304
John Deere 200 LC/200C LC/200D LC, P-P 472mm	121794-7201	331	\$2,304
John Deere 210C W, P-P 472mm	121794-7201	331	\$2,304
Kobelco SK 135SR, P-P 420mm	121794-2131	265	\$2,390
Kobelco SK 140SRLC/SK 140SRLC-3/SK 140SRLC-5, P-P 420mm	121794-2131	265	\$2,390
Kobelco ED 150, P-P 420mm	121794-2131	265	\$2,390
Kobelco SK 150LC MARK III, P-P 400mm	121794-2150	273	\$2,390
Kobelco SK 150LC MARK IV, P-P 411mm	121794-2151	275	\$1,872
Kobelco ED 160-3/ED 160-5, P-P 420mm	121794-2131	265	\$2,390
Kobelco SK 160LC-6, P-P 411mm	121794-2151	275	\$1,872
Kobelco SK 170LC-8/SK 170LC-9/SK 170LC-10, P-P 411mm	121794-2151	275	\$1,872
Kobelco ED 190-6, P-P 411mm	121794-2151	275	\$1,872
Kobelco ED 195-8, P-P 411mm	121794-2151	275	\$1,872
Kobelco SK 200LC-MARK III/SK 200-3, P-P 430mm	121794-2200	323	\$2,390
Kobelco SK 200LC MARK IV, P-P 442mm	121794-2201	325	\$2,304
Kobelco SK 200SRLC, P-P 442mm	121794-2201	325	\$2,304
Kobelco SK 210LC-6/SK 210LC-8/SK 210LC-9/SK 210LC-10, P-P 442mm	121794-2201	325	\$2,304
Komatsu PC 138USLC-2/PC 138USLC-8/PC 138USLC-10, P-P 374.9mm	121794-0158	250	\$2,390
Komatsu PC 150LC-5/PC 150LC-6, P-P 400.8mm	121794-0150	274	\$2,304
Komatsu PC 158USLC-2/PC 158USLC-6, P-P 374.9mm	121794-0158	250	POR
Komatsu PC 160LC-7/PC 160LC-8, P-P 400.8mm	121794-0150	274	\$2,304
Komatsu PC 170LC-10, P-P 400.8mm	121794-0150	274	\$2,304
Komatsu PW 170ES-6, P-P 400.8mm	121794-0150	274	\$2,304
Komatsu PC 180LC-7, P-P 400.8mm	121794-0150	274	\$2,304
Komatsu PC 200LC-5/PC 200LC-6/PC 200LC-7/PC 200LC-8, P-P 458.1mm	121794-0200	329	\$2,549
Link-Belt 135 SPIN ACE, P-P 385mm	121794-9010	259	\$2,304
Link-Belt 145 X3 SPIN ACE, P-P 385mm	121794-9010	259	\$2,304
Link-Belt 160 LX/160 X2/160 X3/160 X4, P-P 435mm	121794-9020	324	\$2,304
Link-Belt 210 LX/210 X2/210 X3/210 X4, P-P 440mm	121794-2802	324	\$2,304
Takeuchi TB 1140-S2, P-P 362mm	121794-7120	362	\$2,304
Volvo EC 140B/EC 140C/EC 140D, P-P 380mm	121794-5130	259	\$2,304
Volvo ECR 145C/ECR 145D/ECR 145E, P-P 380mm	121794-5130	259	\$2,304
Volvo EC 150, P-P 423mm	121794-5150	277	\$1,936
Volvo EC 160B/EC 160C, P-P 440mm	121794-5160	280	\$1,941
Volvo EC 160D, P-P 423mm	121794-5150	277	\$1,936
Volvo EW 160C/EW 160D, P-P 440mm	121794-5160	280	\$1,941
Volvo EW 170, P-P 423mm	121794-2170	278	\$2,304

EXCAVATOR MOUNTS CONTINUED NEXT PAGE

## MULCHERS FOR EXCAVATORS CONT.

EXCAVATOR MOUNTS CONT.	ORDER CODE	SHIP WEIGHT (LBS)	LIST PRICE
<b>MM421 Series II Excavator Mounts - Contact Factory for Mounts Not Listed</b>			
Volvo EC 180C, P-P 440mm	121794-5160	280	\$1,941
Volvo EC 180D, P-P 423mm	121794-5150	277	\$1,936
Volvo EW 180/EW 180C/EW 180D, P-P 423mm	121794-2170	278	\$2,304
Volvo EC 210/EC 210B/EC 210C, P-P 467mm	121794-4210	331	\$2,462
Volvo EW 210C/EW 210D, P-P 423mm	121794-2170	278	\$2,304
Volvo S1 Mounting	121794-2141	382	\$3,712
Volvo S6 Mounting, P-P 480mm	121794-2140	243	\$2,390
CWS HE120 WBM Manual Wedge Coupler, P-P 355mm	121794-2154	245	\$2,390
<b>MM422 Series II Excavator Mounts - Contact Factory for Mounts Not Listed</b>			
Case CX 210/CX 210B/CX 210C/CX 210D, P-P 450mm	121795-9030	320	\$2,304
Case CX 225 MSR, P-P 450mm	121795-9030	320	\$2,304
Case CX 235C SR, P-P 450mm	121795-9030	320	\$2,304
Case CX 240/CX 240B, P-P 490mm	121795-9040	354	\$2,199
Case CX 250C/CX 250D, P-P 490mm	121795-9040	354	\$2,199
Case CX 290/CX 290B, P-P 490mm	121795-9040	354	\$2,199
Case CX 300D, P-P 490mm	121795-9040	354	\$2,199
Caterpillar 320/320B/320C/320D/320E/320F, P-P 445mm	121795-0320	319	\$2,304
Caterpillar 320/320B/320C/320D/320E/320F, P-P 485mm	121795-0322	325	\$2,304
Caterpillar M320F, P-P 445mm	121795-0320	319	\$2,304
Caterpillar M320F, P-P 485mm	121795-0322	325	\$2,304
Caterpillar 321C/321D, P-P 445mm	121795-0320	319	\$2,304
Caterpillar 321C/321D, P-P 485mm	121795-0322	325	\$2,304
Caterpillar 322/322B/322C, P-P 485mm	121795-0322	325	\$2,304
Caterpillar 322/322B/322C, P-P 512mm	121795-2322	328	\$2,304
Caterpillar M322C/M322D, P-P 445mm	121795-0320	319	\$2,304
Caterpillar M322C/M322D, P-P 485mm	121795-0322	325	\$2,304
Caterpillar 323D/323E/323F, P-P 445mm	121795-0320	319	\$2,304
Caterpillar 323D/323E/323F, P-P 485mm	121795-0322	325	\$2,304
Caterpillar 324D/324E, P-P 485mm	121795-0324	355	\$2,304
Caterpillar 324D/324E, P-P 512mm	121795-1324	358	POR
Caterpillar 325/325B/325C, P-P 485mm	121795-0325	333	\$2,390
Caterpillar 325/325B/325C, P-P 512mm	121795-2325	337	\$2,304
Caterpillar 325D/325F, P-P 485mm	121795-0324	355	\$2,304
Caterpillar 325D/325F, P-P 512mm	121795-1324	358	\$2,390
Caterpillar 326F, P-P 485mm	121795-0324	355	\$2,304
Caterpillar 326F, P-P 512mm	121795-1324	358	\$2,390
Caterpillar 329D/329E/329F, P-P 485mm	121795-0324	355	\$2,304
Caterpillar 329D/329E/329F, P-P 512mm	121795-1324	358	\$2,390
Doosan DX 210W/DX 210W-5, P-P 464mm	121795-4220	330	\$2,397
Doosan DX 225LC/DX 225LC-3/DX 225LC-5, P-P 464mm	121795-4220	330	\$2,397
Doosan DX 235LCR, P-P 464mm	121795-4220	330	\$2,397
Doosan DX 255LC/DX 255LC-5, P-P 488mm	121795-4221	333	\$2,390

EXCAVATOR MOUNTS CONTINUED NEXT PAGE

# MULCHERS

## MULCHERS FOR EXCAVATORS CONT.

EXCAVATOR MOUNTS CONT.	ORDER CODE	SHIP WEIGHT (LBS)	LIST PRICE
<b>MM422 Series II Excavator Mounts - Contact Factory for Mounts Not Listed</b>			
Doosan DX 300, P-P 508mm	121795-3290	373	\$2,390
Hitachi ZX 190W-3, P-P 472mm	121795-7201	323	\$2,147
Hitachi EX 200LC/EX 200LC-2/EX 200LC-3/EX 200LC-5, P-P 472mm	121795-7201	323	\$2,147
Hitachi ZX 200LC/ZX 200LC-3, P-P 472mm	121795-7201	323	\$2,147
Hitachi ZX 210LC-5, P-P 472mm	121795-7201	323	\$2,147
Hitachi ZX 210W, P-P 472mm	121795-7201	323	\$2,147
Hitachi EX 220LC-3, P-P 475mm	121795-7230	372	\$2,304
Hitachi ZX 220W-3, P-P 472mm	121795-7201	323	\$2,147
Hitachi ZX 225USLC/ZX 225USLC-3, P-P 472mm	121795-7201	323	\$2,147
Hitachi EX 230LC-5, P-P 475mm	121795-7230	372	\$2,304
Hitachi ZX 230LC, P-P 475mm	121795-7230	372	\$2,304
Hitachi ZX 240LC-3, P-P 475mm	121795-7230	372	\$2,304
Hitachi ZX 245USLC-5, P-P 472mm	121795-7201	323	\$2,147
Hitachi ZX 250LC-5, P-P 475mm	121795-7230	372	\$2,304
Hitachi EX 270LC-5, P-P 475mm	121795-7230	372	\$2,304
Hitachi ZX 270LC/ZX 270LC-3, P-P 475mm	121795-7230	372	\$2,304
Hitachi ZX 290LC-5, P-P 475mm	121795-7230	372	\$2,304
Hyundai R 200W-7/R 200W-7A, P-P 460mm	121795-4201	330	\$2,207
Hyundai HW 210, P-P 460mm	121795-4201	330	\$2,207
Hyundai R 210LC-7/R 210LC-7A/R 210LC-9, P-P 460mm	121795-4201	330	\$2,207
Hyundai R 210W-9/R 210W-9A, P-P 460mm	121795-4201	330	\$2,207
Hyundai HX 220L, P-P 460mm	121795-4201	330	\$2,207
Hyundai R 220LC-9A, P-P 460mm	121795-4201	330	\$2,207
Hyundai HX 235LCR, P-P 460mm	121795-4201	330	\$2,207
Hyundai R 235LCR-9/R 235LCR-9A, P-P 460mm	121795-4201	330	\$2,207
Hyundai R 250LC-7/R 250LC-7A/R 250LC-9, P-P 510mm	121795-1291	376	\$2,304
Hyundai HX 260L, P-P 510mm	121795-1291	376	\$2,304
Hyundai R 260LC-9A, P-P 510mm	121795-1291	376	\$2,304
Hyundai R 290LC-7/R 290LC-7A/R 290LC-9, P-P 510mm	121795-1291	376	\$2,304
Hyundai HX 300L, P-P 510mm	121795-1291	376	\$2,304
Hyundai R 300LC-9A, P-P 510mm	121795-1291	376	\$2,304
JCB JS 190, P-P 435mm	121795-9020	316	\$2,414
JCB JS 200, P-P 450mm	121795-9030	320	\$2,304
JCB JS 200W, P-P 450mm	121795-9030	320	\$2,304
JCB JS 210, P-P 450mm	121795-9030	320	\$2,304
JCB JS 220, P-P 450mm	121795-9030	320	\$2,304
JCB JS 235, P-P 450mm	121795-9030	320	\$2,304
JCB JZ 235, P-P 450mm	121795-9030	320	\$2,304
JCB JS 240, P-P 460mm	121795-9240	351	\$2,265
JCB JZ 255, P-P 450mm	121795-9030	320	\$2,304
JCB JS 260, P-P 460mm	121795-9240	351	\$2,265

EXCAVATOR MOUNTS CONTINUED NEXT PAGE

## MULCHERS FOR EXCAVATORS CONT.

EXCAVATOR MOUNTS CONT.	ORDER CODE	SHIP WEIGHT (LBS)	LIST PRICE
<b>MM422 Series II Excavator Mounts - Contact Factory for Mounts Not Listed</b>			
John Deere 200 LC/200C LC/200D LC, P-P 472mm	121795-7201	323	\$2,147
John Deere 210G LC, P-P 472mm	121795-7201	323	\$2,147
John Deere 210C W, P-P 472mm	121795-7201	323	\$2,147
John Deere 220D W, P-P 472mm	121795-7201	323	\$2,147
John Deere 225C LC/225D LC, P-P 472mm	121795-7201	323	\$2,147
John Deere 230 LC/230C LC, P-P 475mm	121795-7230	372	\$2,304
John Deere 240D LC, P-P 475mm	121795-7230	372	\$2,304
John Deere 245G LC, P-P 472mm	121795-7201	323	\$2,147
John Deere 250G LC, P-P 475mm	121795-7230	372	\$2,304
John Deere 270 LC/270C LC/270D LC, P-P 475mm	121795-7230	372	\$2,304
John Deere 290G LC, P-P 475mm	121795-7230	372	\$2,304
John Deere 300G LC, P-P 475mm	121795-7230	372	\$2,304
John Deere 350D, P-P 585mm	121795-7330	434	\$2,304
Kobelco SK 200LC-MARK III/SK 200-3, P-P 430mm	121795-2200	316	\$2,390
Kobelco SK 210LC-6/SK 210LC-8/SK 210LC-9/SK 210LC-10, P-P 442mm	121795-2201	318	\$2,147
Kobelco SK 215SRLC, P-P 442mm	121795-2201	318	\$2,147
Kobelco SK 220LC MARK III, P-P 500mm	121795-2220	355	\$2,390
Kobelco SK 220LC MARK IV, P-P 514mm	121795-2221	358	\$2,286
Kobelco SK 230SRLC-3/SK 230SRLC-5, P-P 442mm	121795-2201	318	\$2,147
Kobelco SK 235SRLC, P-P 442mm	121795-2201	318	\$2,147
Kobelco SK 250LC-6, P-P 514mm	121795-2221	358	\$2,286
Kobelco SK 260LC-8/SK 260LC-9/SK 260LC-10, P-P 514mm	121795-2221	358	\$2,286
Kobelco SK 260SRLC-3, P-P 442mm	121795-2201	318	\$2,147
Kobelco SK 270LC MARK IV, P-P 514mm	121795-2221	358	\$2,286
Kobelco SK 270SRLC-5, P-P 442mm	121795-2201	318	\$2,147
Kobelco SK 290LC-6, P-P 527mm	121795-2290	375	\$2,390
Kobelco SK 295LC-8/SK 295LC-9, P-P 527mm	121795-2290	375	\$2,390
Kobelco SK 300LC-10, P-P 527mm	121795-2290	375	\$2,390
Komatsu PC 200LC-5/PC 200LC-6/PC 200LC-7/PC 200LC-8, P-P 458mm	121795-0200	322	\$1,675
Komatsu PC 210LC-10/PC 210LC-11, P-P 458mm	121795-0200	322	\$1,675
Komatsu HB 215LC-1, P-P 458mm	121795-0200	322	\$1,675
Komatsu PC 220LC-5/PC 220LC-6/PC 220LC-7/PC 220LC-8, P-P 446mm	121795-0220	320	\$2,549
Komatsu PC 228USLC-3/PC 228USLC-8/PC 228USLC-10, P-P 458mm	121795-0200	322	\$1,675
Komatsu PC 240LC-10/PC 240LC-11, P-P 446mm	121795-0220	320	\$2,549
Komatsu PC 250LC-6, P-P 446mm	121795-0220	320	\$2,549
Komatsu PC 270LC-6/PC 270LC-7/PC 270LC-8, P-P 446mm	121795-0220	320	\$2,549
Komatsu PC 290LC-10/PC 290LC-11, P-P 446mm	121795-0220	320	\$2,549
Komatsu PC 300 / PC 360, P-P 514mm	121795-0300	358	\$2,304

EXCAVATOR MOUNTS CONTINUED NEXT PAGE

# MULCHERS

## MULCHERS FOR EXCAVATORS CONT.

EXCAVATOR MOUNTS CONT.	ORDER CODE	SHIP WEIGHT (LBS)	
<b>MM422 Series II Excavator Mounts - Contact Factory for Mounts Not Listed</b>			
Link-Belt 210 LX/210 X2/210 X3/210 X4, P-P 440mm	121795-2802	317	\$2,304
Link-Belt 225 SPIN ACE, P-P 440mm	121795-2802	317	\$2,304
Link-Belt 235 X3 SPIN ACE, P-P 440mm	121795-2802	317	\$2,304
Link-Belt 240 LX/240 X2, P-P 460mm	121795-9240	351	\$2,265
Link-Belt 250 X3/250 X4, P-P 460mm	121795-9240	351	\$2,265
Link-Belt 290 LX/290 X2, P-P 460mm	121795-9240	351	\$2,265
Link-Belt 300 X3/300 X4, P-P 460mm	121795-9240	351	\$2,265
Volvo EC 210/EC 210B/EC 210C, P-P 467mm	121795-4210	323	\$2,304
Volvo EC 220D/EC 220E, P-P 467mm	121795-4210	323	\$2,304
Volvo EW 230C, P-P 467mm	121795-4210	323	\$2,304
Volvo ECR 235C/ECR 235D/ECR 235E, P-P 467mm	121795-4210	323	\$2,304
Volvo EC 240B/EC 240C, P-P 506mm	121795-4240	373	\$2,637
Volvo EC 250D, P-P 506mm	121795-4240	373	\$2,637
Volvo EC 290/EC 290B/EC 290C, P-P 495mm	121795-5280	374	\$2,304
Volvo EC 300D, P-P 495mm	121795-5280	374	\$2,304
Volvo S1 MOUNTING	121795-2141	371	\$2,390
<b>MM601 Series II Excavator Mounts - Contact Factory for Mounts Not Listed</b>			
Case CX 210/CX 210B/CX 210C/CX 210D, P-P 450mm	121794-9030	327	\$2,390
Case CX 225 MSR, P-P 450mm	121794-9030	327	\$2,390
Case CX 235C SR, P-P 450mm	121794-9030	327	\$2,390
Case CX 240/CX 240B, P-P 490mm	121794-9040	362	\$2,199
Case CX 250C/CX 250D, P-P 490mm	121794-9040	362	\$2,199
Caterpillar 316E/316F, P-P 463mm	121794-0315	283	\$2,304
Caterpillar M316D/M316F, P-P 463mm	121794-0315	283	\$2,304
Caterpillar 318B/318C, P-P 445mm	121794-0320	327	\$2,262
Caterpillar 318B/318C, P-P 485mm	121794-0322	332	POR
Caterpillar 318E/318F, P-P 463mm	121794-0315	283	\$2,304
Caterpillar M318C/M318D, P-P 445mm	121794-0320	327	\$2,262
Caterpillar M318C/M318D, P-P 485mm	121794-0322	332	POR
Caterpillar M318F, P-P 463mm	121794-0315	283	\$2,304
Caterpillar 319D, P-P 445mm	121794-0320	327	\$2,262
Caterpillar 319D, P-P 485mm	121794-0322	332	POR
Caterpillar 320/320B/320C/320D/320E/320F, P-P 445mm	121794-0320	327	\$2,262
Caterpillar 320/320B/320C/320D/320E/320F, P-P 485mm	121794-0322	332	POR
Caterpillar M320F, P-P 445mm	121794-0320	327	\$2,262
Caterpillar M320F, P-P 485mm	121794-0322	332	POR
Caterpillar 321C/321D, P-P 445mm	121794-0320	327	\$2,262
Caterpillar 321C/321D, P-P 485mm	121794-0322	332	POR
Caterpillar 322/322B/322C, P-P 485mm	121794-0322	332	POR
Caterpillar 322/322B/322C, P-P 512mm	121794-2322	336	\$2,390
Caterpillar M322C/M322D, P-P 445mm	121794-0320	327	\$2,262
Caterpillar M322C/M322D, P-P 485mm	121794-0322	332	POR
Caterpillar 323D/323E/323F, P-P 445mm	121794-0320	327	\$2,262
Caterpillar 323D/323E/323F, P-P 485mm	121794-0322	332	POR
Caterpillar 324D/324E, P-P 485mm	121794-0324	362	\$2,390
Caterpillar 324D/324E, P-P 512mm	121794-0324	362	\$2,390

EXCAVATOR MOUNTS CONTINUED NEXT PAGE

## MULCHERS FOR EXCAVATORS CONT.

EXCAVATOR MOUNTS CONT.	ORDER CODE	SHIP WEIGHT (LBS)	
<b>MM601 Series II Excavator Mounts - Contact Factory for Mounts Not Listed</b>			
Doosan DX 180LC/DX 180LC-3/DX 180LC-5, P-P 464mm	121794-4220	338	\$2,304
Doosan DX 190W-3/DX 190W-5, P-P 464mm	121794-4220	338	\$2,304
Doosan DX 210W/DX 210W-5, P-P 464mm	121794-4220	338	\$2,304
Doosan DX 225LC/DX 225LC-3/DX 225LC-5, P-P 464mm	121794-4220	338	\$2,304
Doosan DX 235LCR, P-P 464mm	121794-4220	338	\$2,304
Hitachi EX 160LC-5, P-P 391mm	121794-7150	316	\$2,304
Hitachi ZX 160LC/ZX 160LC-3/ZX 160LC-5, P-P 391mm	121794-7150	316	\$2,304
Hitachi ZX 180LC-5, P-P 472mm	121794-7201	331	\$2,304
Hitachi ZX 180W, P-P 472mm	121794-7201	331	\$2,304
Hitachi ZX 190W-3, P-P 472mm	121794-7201	331	\$2,304
Hitachi EX 200LC/EX 200LC-2/EX 200LC-3/EX 200LC-5, P-P 472mm	121794-7201	331	\$2,304
Hitachi ZX 200LC/ZX 200LC-3, P-P 472mm	121794-7201	331	\$2,304
Hitachi ZX 210LC-5, P-P 472mm	121794-7201	331	\$2,304
Hitachi ZX 210W, P-P 472mm	121794-7201	331	\$2,304
Hitachi EX 220LC-3, P-P 475mm	121794-7230	385	\$2,304
Hitachi ZX 220W-3, P-P 472mm	121794-7201	331	\$2,304
Hitachi ZX 225USLC/ZX 225USLC-3, P-P 472mm	121794-7201	331	\$2,304
Hitachi EX 230LC-5, P-P 475mm	121794-7230	385	\$2,304
Hitachi ZX 230LC, P-P 475mm	121794-7230	385	\$2,304
Hitachi ZX 240LC-3, P-P 475mm	121794-7230	385	\$2,304
Hitachi ZX 245USLC-5, P-P 472mm	121794-7201	331	\$2,304
Hitachi ZX 250LC-5, P-P 475mm	121794-7230	385	\$2,304
Hyundai HX 160L, P-P 410mm	121794-2180	275	POR
Hyundai R 160LC-7/R 160LC-7A/R 160LC-9/R 160LC-9A, P-P 410mm	121794-2180	275	POR
Hyundai R 170W-7/R 170W-7A/R 170W-9, P-P 410mm	121794-2180	275	POR
Hyundai HW 180, P-P 410mm	121794-2180	275	POR
Hyundai HX 180L, P-P 410mm	121794-2180	275	POR
Hyundai R 180LC-7/R 180LC-7A/R 180LC-9/R 180LC-9A, P-P 410mm	121794-2180	275	POR
Hyundai R 200W-7/R 200W-7A, P-P 460mm	121794-4201	337	POR
Hyundai HW 210, P-P 460mm	121794-4201	337	POR
Hyundai R 210LC-7/R 210LC-7A/R 210LC-9, P-P 460mm	121794-4201	337	POR
Hyundai R 210W-9/R 210W-9A, P-P 460mm	121794-4201	337	POR
Hyundai HX 220L, P-P 460mm	121794-4201	337	POR
Hyundai R 220LC-9A, P-P 460mm	121794-4201	337	POR
Hyundai HX 235LCR, P-P 460mm	121794-4201	337	POR
Hyundai R 235LCR-9/R 235LCR-9A, P-P 460mm	121794-4201	337	POR
JCB JS 160, P-P 435mm	121794-9020	324	\$2,304
JCB JS 160W, P-P 435mm	121794-9020	324	\$2,304
JCB JS 175W, P-P 435mm	121794-9020	324	\$2,304
JCB JS 180, P-P 435mm	121794-9020	324	\$2,304
JCB JS 190, P-P 435mm	121794-9020	324	\$2,304
JCB JS 200, P-P 450mm	121794-9030	327	\$2,390
JCB JS 200W, P-P 450mm	121794-9030	327	\$2,390
JCB JS 210, P-P 450mm	121794-9030	327	\$2,390
JCB JS 220, P-P 450mm	121794-9030	327	\$2,390

EXCAVATOR MOUNTS CONTINUED NEXT PAGE

# MULCHERS

## MULCHERS FOR EXCAVATORS CONT.

EXCAVATOR MOUNTS CONT.	ORDER CODE	SHIP WEIGHT (LBS)	LIST PRICE
<b>MM601 Series II Excavator Mounts - Contact Factory for Mounts Not Listed</b>			
JCB JS 235, P-P 450mm	121794-9030	327	\$2,390
JCB JZ 235, P-P 450mm	121794-9030	327	\$2,390
JCB JS 240, P-P 460mm	121794-9240	358	\$2,284
JCB JZ 255, P-P 460mm	121794-9030	327	\$2,390
John Deere 160 LC/160C LC/160D LC/160G LC, P-P 391mm	121794-7150	316	\$2,304
John Deere 180G LC, P-P 472mm	121794-7201	331	\$2,304
John Deere 180C W, P-P 472mm	121794-7201	331	\$2,304
John Deere 190D W/190G W, P-P 472mm	121794-7201	331	\$2,304
John Deere 200 LC/200C LC/200D LC, P-P 472mm	121794-7201	331	\$2,304
John Deere 210G LC, P-P 472mm	121794-7201	331	\$2,304
John Deere 210C W, P-P 472mm	121794-7201	331	\$2,304
John Deere 220D W, P-P 472mm	121794-7201	331	\$2,304
John Deere 225C LC/225D LC, P-P 472mm	121794-7201	331	\$2,304
John Deere 230 LC/230C LC, P-P 475mm	121794-7230	385	\$2,304
John Deere 240D LC, P-P 475mm	121794-7230	385	\$2,304
John Deere 245G LC, P-P 472mm	121794-7201	331	\$2,304
John Deere 250G LC, P-P 475mm	121794-7230	385	\$2,304
Kobelco SK 160LC-6, P-P 411mm	121794-2151	275	\$1,872
Kobelco SK 170LC-8/SK 170LC-9/SK 170LC-10, P-P 411mm	121794-2151	275	\$1,872
Kobelco ED 190-6, P-P 411mm	121794-2151	275	\$1,872
Kobelco ED 195-8, P-P 411mm	121794-2151	275	\$1,872
Kobelco SK 200LC-MARK III/SK 200-3, P-P 430mm	121794-2200	323	POR
Kobelco SK 200LC MARK IV, P-P 442mm	121794-2201	325	\$2,304
Kobelco SK 200SRLC, P-P 442mm	121794-2201	325	\$2,304
Kobelco SK 210LC-6/SK 210LC-8/SK 210LC-9/SK 210LC-10, P-P 442mm	121794-2201	325	\$2,304
Kobelco SK 215SRLC, P-P 442mm	121794-2201	325	\$2,304
Kobelco SK 220LC MARK III, P-P 500mm	121794-2220	363	\$2,390
Kobelco SK 220LC MARK IV, P-P 514mm	121794-2221	365	\$2,390
Kobelco SK 230SRLC-3/SK 230SRLC-5, P-P 442mm	121794-2201	325	\$2,304
Kobelco SK 235SRLC, P-P 442mm	121794-2201	325	\$2,304
Kobelco SK 250LC-6, P-P 514mm	121794-2221	365	\$2,390
Komatsu PC 160LC-7/PC 160LC-8, P-P 401mm	121794-0150	274	\$2,304
Komatsu PC 170LC-10, P-P 401mm	121794-0150	274	\$2,304
Komatsu PW 170ES-6, P-P 401mm	121794-0150	274	\$2,304
Komatsu PC 180LC-7, P-P 401mm	121794-0150	274	\$2,304
Komatsu PC 200LC-5/PC 200LC-6/PC 200LC-7/PC 200LC-8, P-P 458mm	121794-0200	328	\$2,549
Komatsu PC 210LC-10/PC 210LC-11, P-P 458mm	121794-0200	328	\$2,549
Komatsu HB 215LC-1, P-P 458mm	121794-0200	328	\$2,549
Komatsu PC 220LC-5/PC 220LC-6/PC 220LC-7/PC 220LC-8, P-P 446mm	121794-0220	329	POR
Komatsu PC 228USLC-3/PC 228USLC-8/PC 228USLC-10, P-P 458mm	121794-0200	328	\$2,549
Komatsu PC 240LC-10/PC 240LC-11, P-P 446mm	121794-0220	329	POR

EXCAVATOR MOUNTS CONTINUED NEXT PAGE

## MULCHERS FOR EXCAVATORS CONT.

EXCAVATOR MOUNTS CONT.	ORDER CODE	SHIP WEIGHT (LBS)	LIST PRICE
<b>MM601 Series II Excavator Mounts - Contact Factory for Mounts Not Listed</b>			
Link-Belt 160 LX/160 X2/160 X3/160 X4, P-P 435mm	121794-9020	324	\$2,304
Link-Belt 210 LX/210 X2/210 X3/210 X4, P-P 440mm	121794-2802	324	\$2,304
Link-Belt 225 SPIN ACE, P-P 440mm	121794-2802	324	\$2,304
Link-Belt 235 X3 SPIN ACE, P-P 440mm	121794-2802	324	\$2,304
Link-Belt 240 LX/240 X2, P-P 460mm	121794-9240	358	\$2,284
Link-Belt 250 X3/250 X4, P-P 460mm	121794-9240	358	\$2,284
Volvo EC 160B/EC 160C, P-P 440mm	121794-5160	280	\$1,941
Volvo EC 160D, P-P 423mm	121794-5150	277	\$1,936
Volvo EW 160C/EW 160D, P-P 440mm	121794-5160	280	\$1,941
Volvo EW 170, P-P 423mm	121794-2170	278	\$2,304
Volvo EC 180C, P-P 440mm	121794-5160	280	\$1,941
Volvo EC 180D, P-P 423mm	121794-5150	277	\$1,936
Volvo EW 180/EW 180C/EW 180D, P-P 423mm	121794-2170	278	\$2,304
Volvo EC 210/EC 210B/EC 210C, P-P 467mm	121794-4210	331	\$2,462
Volvo EW 210C/EW 210D, P-P 423mm	121794-2170	278	\$2,304
Volvo EC 220D/EC 220E, P-P 467mm	121794-4210	331	\$2,462
Volvo EW 230C, P-P 467mm	121794-4210	331	\$2,462
Volvo ECR 235C/ECR 235D/ECR 235E, P-P 467mm	121794-4210	331	\$2,462
Volvo EC 240B/EC 240C, P-P 506mm	121794-4240	383	\$2,390
Volvo EC 250D, P-P 506mm	121794-4240	383	\$2,390
Volvo S1 MOUNTING	121794-2141	382	\$3,712

Add Surcharge to all products 8.85%

# MULCHERS

## FD60 FORESTRY DISK MULCHER



- Designed to reduce jamming
- Ultra-efficient drive system with fast start
- MulchPower™ Gauge for maximum energy
- Bearing housing never needs to be greased
- Debris shovel keeps teeth out of the dirt and guides material for processing
- High-quality QUADCO teeth are interchangeable, allowing for simple service and rotation
- Fells trees up to 14"
- Processes up to 8"
- Stump grinds to grade

Specifications				
FLOW RANGE	OPERATING PRESSURE	HEIGHT	OVERALL WIDTH	LENGTH
30 - 45 GPM	3,300 minimum	39.5"	75.75"	75.5"

## FORESTRY DISK MULCHER FOR SKID-STEER LOADERS



MULCHER ASSEMBLY	ORDER CODE	SHIP WEIGHT (LBS)	LIST PRICE
FD60 60" Forestry Disk Mulcher, 1/2" QD, Case Drain	125260-0022	2217	\$33,178
FD60 60" Forestry Disk Mulcher, 5/8" QD, Case Drain	125260-9903	2217	\$33,178
FD60 60" Forestry Disk Mulcher, 3/4" QD, Case Drain	125260-9925	2217	\$33,178

REPLACEMENT PARTS	ORDER CODE	SHIP WEIGHT (LBS)	LIST PRICE
Partial Tooth Replacement Kit (20 Teeth and Hardware)	125288	30.5	\$1,579
Tooth - Individual	124861	1	\$70
Tooth Bolt 3.50" - Individual	10322	1	\$20
Tooth Bolt 4.00" - Individual	10323	1	\$22
Skid Shoe Replacement Kit - Right Side	125984	15	\$128
Skid Shoe Replacement Kit - Left Side	125985	15	\$79
Debris Shovel Replacement Kit	125986	85	\$527
Swinging Debris Door Replacement Kit	125959	40	\$623
Hose w/Sock .38x112 6FJ-8MB 100R2AT HS	38162	4	\$118
Hose w/Sock .75x108 12FJ-12MB 4K HS	37769	2	\$340
Hose Coupler .38" body female QD 6 FF F 8FB	84928	1	POR
Hose Coupler .38" body male QD 6 FF M 8FB	84923	1	POR
Hose Coupler .50" body female QD 8 FF F 12FB	22518	2	\$80
Hose Coupler .50" body female QD 8 FF M 12FB	22519	2	\$55
Hose Coupler .625" body female QD 10 FF F 12FB	84921	3	\$231
Hose Coupler .625" body male QD 10 FF M 12FB	84922	3	POR
Hose Coupler .75" body female QD 12 FF F 12FB	22520	2	\$303
Hose Coupler .75" body male QD 12 FF M 12FB	22521	3	\$263

## POST DRIVER



- Manual side shift
- Operates off skid-steer hydraulics
- Does not mushroom posts
- No shock load back to skid steer
- Optional striker plates to match post shape

Specifications				
Model	Weight (approx)	Width	Height	Hydraulic Flow
PD4800	1360 lbs	54.25"	91.48"	24 gpm

## POST DRIVER FOR SKID-STEER LOADERS



**TO ORDER: CHOOSE POST DRIVER, COLLAR ASSEMBLY AND HOSE KIT TO MATCH YOUR SKID-STEER.**

POST DRIVER (NO HOSES)	ORDER CODE	SHIP WEIGHT (LBS)	LIST PRICE
PD4800 post driver	111487	1360	\$9,053

COLLAR ASSEMBLY WITH STRIKER PLATES (ONE REQUIRED)	ORDER CODE	SHIP WEIGHT (LBS)	LIST PRICE
3.5" square collar with striker plate assembly	112493	63	\$1,128
6.0" square collar with striker plate assembly	112492	65	\$1,128
8.0" square collar with striker plate assembly	112491	66	\$1,225
6" x 8" square collar with striker plate assembly	112494	64	\$1,128

HOSE KITS	ORDER CODE	SHIP WEIGHT (LBS)	LIST PRICE
80" with .50" body flat face couplers	112919	25	\$287
108" with .50" body flat face couplers	112920	30	\$446
tilt attach hose kit complete with valve package (requires BRADCO TILT-A-TACH)	112921	25	\$1,207

OPTIONS	ORDER CODE	SHIP WEIGHT (LBS)	LIST PRICE
<b>Collars</b>			
3" round collar	19964	15	\$604
3.5" square collar	88812	15	\$604
4" round collar	19965	15	\$604
4" x 6" "H" beam	88815	15	\$604
6" round collar	88813	15	\$593
8" square collar	32712	15	\$610
6" x 8" collar	89147	15	\$557
6" square collar	89413	15	\$604
T post Adapter	87122	15	\$293
Tilt Attach Assy, HD	17446	386	\$3,963
universal valve package (required for Tilt Attach)	88725	23	\$1,325
Control box w/ power lead (required for Tilt Attach)	28-10754	5	\$383

POST DRIVER CONTROLS CONTINUED NEXT PAGE

# POST DRIVER

## POST DRIVER FOR SKID-STEER LOADERS CONT.

HYDRAULIC CONTROL AND WIRE HARNESS OPTIONS	ORDER CODE	SHIP WEIGHT (LBS)	LIST PRICE
universal valve package (required for Tilt Attach)	88725	23	\$1,325
Control box w/ power lead (required for Tilt Attach)	28-10754	5	\$383
Control box w/ power lead	28-10754	5	\$383
Wire harness for CAT pre-B (8-pin Deutsch)	07-10021	5	\$372
Wire harness for CAT (14-pin "D" series)	07-8344	5	\$273
Wire harness for standard flow attachments on CAT B and C (8-pin Deutsch)	07-10122	5	\$346
Wire Harness (multi function in cab controls) for CNH, JCB, Bobcat, Mustang, Kubota, Takeuchi, Volvo 14 Pin-8 Pin	LAF9360-0000	5	\$268
Wire harness for CNH (8-pin rectangular)	LAF9393	5	\$222
Wire harness for John Deere (3-pin Deutsch)	07-7338	5	\$278
Wire harness for John Deere-8 button (14-pin Deutsch)	LAF9361	5	\$362
Wire harness for John Deere EH control (14-pin Deutsch)	07-7626	5	\$711
Wire harness for Komatsu (14-pin Deutsch)	07-10194	5	\$377
Wire harness for Komatsu (8-pin Deutsch)	07-10057	5	\$585
<b>Extension</b>			
60" extension	07-7887	2	\$133

Add Surcharge to all products 8.85%

# RAKES



# RAKES

## AUTORAKE



- Grooms and finishes soil for seeding and sodding
- Picks up rocks from .75" to 6" in diameter and collects them in the hopper
- Breaks up clods and levels soils
- Easy to dump collected debris, simply raise the loader arms and open shroud hydraulically

Carrier Specifications	
Lift Capacity	Operating Weight
<9,000 lbs.	<11,000 lbs.

Specifications					
Model #	Approx. Weight	Working Width	Hopper Capacity	PSI Range	GPM Range
LAF6864	1350 lbs	62"	.48 yd <sup>3</sup>	1000-3500	10-25
LAF6874	1455 lbs	72"	.56 yd <sup>3</sup>	1000-3500	10-25

### AUTORAKE FOR SKID-STEER LOADERS





**INCLUDES: AUTORAKE AND UNIVERSAL SSL MOUNTING  
TO ORDER: CHOOSE AUTORAKE AND MOUNTING**

AUTORAKE CHECK LOADER CAPACITY BEFORE ORDERING			
	ORDER CODE	SHIP WEIGHT (LBS)	LIST PRICE
62" AutoRake	LAF6864-0022	1495	\$15,472
72" AutoRake	LAF6874-0022	1695	\$15,977

## PREPARATOR



- Efficiently handles clean-up, rock removal and soil preparation
- Follows ground contour while picking up rocks and debris
- Picks up rocks 1" to 20" in diameter
- Bi-directional drum tills up to 2.5" deep

Specifications						
Model	Weight (approx)	Working Width	Overall Width	Capacity Struck	PSI Range	GPM Range
LAF3566	1445 lbs	66"	74"	.38 yd <sup>3</sup>	2000-3500	10-25
LAF3576	1565 lbs	76"	84"	.46 yd <sup>3</sup>	2000-3500	10-25

Tooth Chart - Quantity needed		
Type	Inside Teeth	Outside Teeth
LAF3554	240	10
LAF3566	300	10
LAF3576	350	10

 **IMPORTANT: All replacement hydraulic hoses and fittings must have a minimum rated working pressure of 4000 psi.**

Carrier Specifications	
Lift Capacity	Operating Weight
<9,000 lbs.	<11,000 lbs.

## PREPARATOR FOR SKID-STEER LOADERS



 **INCLUDES: PREPARATOR AND UNIVERSAL SSL MOUNTING TO ORDER: CHOOSE PREPARATOR AND MOUNTING**

PREPARATOR	ORDER CODE	SHIP WEIGHT (LBS)	LIST PRICE
<b>CHECK LOADER CAPACITY BEFORE ORDERING</b>			
66" Working Width Preparator	LAF3566-0022	1500	\$15,206
76" Working Width Preparator	LAF3576-0022	1650	\$16,046

REPLACEMENT PARTS	ORDER CODE	SHIP WEIGHT (LBS)	LIST PRICE
Inside Tooth for Preparator - See chart for quantity needed	ILA9907-0000	1	\$4
Outside Tooth for Preparator- See chart for quantity needed	ILA9906-0000	1	\$21
FFC Preparator Decal Kit	28-10572	1	\$426
<b>Replaceable Drum</b>			
Replaceable Drum for LAF3566	LAF3505-0000	278	\$3,920
Replaceable Drum for LAF3576	LAF3506-0000	313	\$4,548

# RAKES

## POWER BOX RAKE

**NEW PRODUCT**



- Solid tires eliminate flats to maximize uptime and productivity on debris-heavy jobsites
- Bi-directional motor allows the drum to rotate in either direction maximizing flexibility
- Pure carbide teeth design - specially shaped to ensure the best possible seedbed sub-base fracture pattern and superior moisture retention and release
- The box-end plates are engineered for quick and easy removal, enabling windrowing and reverse box raking without the need for bolts. Simply pull the pins to detach them
- Dual independently adjustable gauge wheels allow for skim passes for seeding - or - adjust to grade and contour

Specifications	MX5	MX6	MX7	MX8
OVERALL HEIGHT	32.9 IN.	33.2 IN.	33.2 IN.	37.3 IN.
OVERALL WIDTH	71.7 IN.	81.7 IN.	93.6 IN.	100.7 IN.
OVERALL LENGTH	60.8 IN.	60.8 IN.	60.8 IN.	67.8 IN.
RAKING WIDTH	62 IN.	72 IN.	84 IN.	90 IN.
OVERALL LENGTH @ 20°	67.1 IN.	68.6 IN.	70.8 IN.	77.8 IN.
OVERALL WIDTH @ 20°	71.1 IN.	80.4 IN.	91.7 IN.	97.8 IN.
RAKING WIDTH @ 20°	60.4 IN.	69.8 IN.	81.1 IN.	86.9 IN.
CENTER OF GRAVITY - MANUAL ANGLE	21.8 IN.	21.9 IN.	21.9 IN.	23.7 IN.
CENTER OF GRAVITY - HYDRAULIC ANGLE	21.4 IN.	21.6 IN.	21.6 IN.	23.3 IN.
WEIGHT - MANUAL ANGLE	900 LBS	954 LBS	1000 LBS	1120 LBS
WEIGHT - HYDRAULIC ANGLE	937 LBS	993 LBS	1037 LBS	1150 LBS
FLOW RANGE	13 - 20 GPM	13 - 25 GPM	15 - 25 GPM	17 - 40 GPM
HYD. MOTOR DISP. (C.I.)	12.3	12.5	15	15
# OF MOTORS	1	1	1	1
MAX PRESSURE (PSI)	3000 PSI	3000 PSI	3000 PSI	3000 PSI
MAX ARTICULATION	20°	20°	20°	20°
RAKE TOOTH TIP DIAMETER	9 IN.	9 IN.	9 IN.	9 IN.

## HARLEY MX SERIES POWER RAKES FOR SKID-STEER LOADERS



SKID-STEER WITH A RATED OPERATING CAPACITY >1,500 LBS	ORDER CODE	SHIP WEIGHT (LBS)	LIST PRICE
MX5 (manual)	25260M-0022	1000	\$11,049
MX5 (hydraulic)	25260H-0022	1037	\$13,005
MX6 (manual)	25272M-0022	1054	\$12,025
MX6 (hydraulic)	25272H-0022	1093	\$13,275
MX7 (manual)	25284M-0022	1100	\$12,899
MX7 (hydraulic)	25284H-0022	1137	\$14,031
MX8 (manual)	25296M-0022	1220	\$15,531
MX8 (hydraulic)	25296H-0022	1250	\$16,142

CONTROLS AND REPLACEMENT PARTS CONTINUED NEXT PAGE

## POWER BOX RAKE CONT.

### HARLEY POWER BOX RAKE FOR SKID-STEER LOADERS

HYDRAULIC CONTROL AND WIRE HARNESS OPTIONS (MUST CHOOSE ONE)	ORDER CODE	SHIP WEIGHT (LBS)	LIST PRICE
Control box w/ power lead	28-10754	5	\$383
7-pin for Bobcat, fits Rakes with Hydraulic Angle*	07-9548	5	\$985
Wire harness for CAT (14-pin "D" series)	07-8344	5	\$273
Wire harness for CAT pre-B (8-pin Deutsch)	07-10021	5	\$372
Wire harness for standard flow attachments on CAT B and C (8-pin Deutsch)	07-10122	5	\$346
Wire harness for John Deere-8 button (14-pin Deutsch)	LAF9361	5	\$362
Wire harness for John Deere EH control (14-pin Deutsch)	07-7626	5	\$711
Wire harness for John Deere (3-pin Deutsch)	07-7338	5	\$278
Wire harness for Komatsu (14-pin Deutsch)	07-10194	5	\$377
Wire harness for Komatsu (8-pin Deutsch)	07-10057	5	\$585
Wire Harness (multi function in cab controls) for CNH, JCB, Bobcat, Mustang, Kubota, Takeuchi, Volvo 14 Pin-8 Pin	LAF9360-0000	5	\$268
Wire harness for CNH (8-pin rectangular)	LAF9393	5	\$222
<b>Extension</b>			
60" extension	07-7887	2	\$133

\*7 Pin Bobcat harness will not work with the Bobcat Toolcat, Versahandler or hand/foot control machines. There is no current harness offering for these machines.

REPLACEMENT PARTS	ORDER CODE	SHIP WEIGHT (LBS)	LIST PRICE
Carbide Tooth - All Models - Qty 1	M6774C		\$29
Carbide Tooth - All Models - Qty 3	M6774-3		\$75
Carbide Tooth - All Models - Qty 10	M3774-10		POR
ASSY TIRE/WHL/HUB 13 X 500-6 2PLY - Model MX4	P752100		\$266
ASSY TIRE/WHL/HUB/BRG/AXLE BOLT/SPACERS - Models MX5, MX6, MX7 & MX8	M16114		\$407
ASSY CASTER HUB - Models MX5, MX6, MX7 & MX8	M16120		\$255
Hydraulic Cylinder Swing Angle - M4H	03-5727		\$532
Hydraulic Cylinder Swing Angle - MX5H, MX6H, MX7H & MX8H	03-5728		\$643
Quick Disconnect Kit	28-9570		\$151
Supply or Return Hose - Manual Angle - Model M4	03-6744		POR
Supply Hose - Hydraulic Angle - Model M4H	03-6744		POR
Return Hose - Hydraulic Angle - Model M4H	03-6742		POR
Supply and Return Hose - Manual Angle - Models MX5, MX6, MX7 & MX8	28-11453-X*		POR
Supply and Return Hose - Hydraulic Angle - Models MX5, MX6, MX7 & MX8	28-11454-X*		POR
Return Hose - Hydraulic Angle - Models MX5, MX6, MX7 & MX8	P255716		\$239

\*\*"X" being the model width, such as 5, 6, 7, or 8

# RAKES

## HARLEY POWER BOX RAKE FOR TRACTORS - 3 POINT



RAKES

### Specifications

Model	Weight (lbs)	HP Range	Working Width - Straight	Working Width @ 15°	3-pt Category
TM4	550	15-22	48"	46"	1
TM5	575	18-32	60"	58"	1
T6	830	30-40	72"	69"	1
TM7	1260	42-80	84"	79"	1.2
TM8	1290	42-80	90"	85"	1.2

### US PATENT NO. 6,578,295

	ORDER CODE	SHIP WEIGHT (LBS)	LIST PRICE
TM-4 (manual)	TM4M-0052	537	\$13,303
TM-4 (hydraulic)	TM4H-0052	537	\$13,356
TM-5 (manual)	TM5M-0052	564	\$11,422
TM-5 (hydraulic)	TM5H-0052	564	\$12,825
T6 (manual)	T6M-0052	871	\$12,775
T6 (hydraulic)	T6H-0052	871	\$14,334
TM-7 (hydraulic)	TM7H-0052	1323	\$15,931
TM-8 (hydraulic)	TM8H-0052	1380	\$16,594

### REPLACEMENT PARTS

	ORDER CODE	SHIP WEIGHT (LBS)	LIST PRICE
Carbide Tooth - All Models - Qty 1	M6774C		\$29
Carbide Tooth - All Models - Qty 3	M6774-3		\$75
Carbide Tooth - All Models - Qty 10	M3774-10		POR
ASSY TIRE/WHL/HUB 13 X 500-6 2PLY - Model TM4 & TM5	P752100		\$266
ASSY TIRE/WHL/HUB/BRG/AXLE BOLT/SPACERS - Models TM6, TM7 & TM8	M16114		\$407
ASSY CASTER HUB - Models M5, M6 & MX7	M16120		\$255
Hydraulic Cylinder, Swing Angle - TM6	03-5726		\$486
Hydraulic Cylinder, Swing Angle - TM4 & TM5	03-5727		\$532
Hydraulic Cylinder, Swing Angle - TM7 & TM8	03-5728		\$643
QD Coupler 8010-4P, Models TM4, TM5 & TM6 - Qty 1	P272600		\$38
Hose, Cylinder Models TM4, TM5, & TM6 - Qty 1	P246472		\$93
QD Coupler 6610-10-10, Models TM7 & TM8 - Qty 1	P272661		\$33
Hose, Cylinder, Models TM7 & TM8 - Qty 1	P248072		\$44

## POWER BOX RAKE - DIRECT DRIVE



- Pulverizes soil, removes debris, finish-grades, spreads fill or soil and dethatches
- Direct-drive motor eliminates chains and sprockets, reducing maintenance
- Heavy-duty frame and carbide teeth increases durability
- 8.6" bi-directional drum works soil forward and backward
- Wheel arms pivot and store in a vertical position

Specifications							
Model #	Approx. Weight	Width OD	Working Width	Height	Drum Torque @2500 PSI	PSI Range	GPM Range
LAF5672 & LAF5672H	1050 lbs	83.0"	72"	30.3"	605 ft-lb	2000-3500	12-40
LAF5690 & LAF5690H	1110 lbs	101.0"	90"	30.3"	605 ft-lb	2000-3500	12-40

Carrier Specifications	
Lift Capacity	Operating Weight
<9,000 lbs.	<11,000 lbs.



**IMPORTANT: All replacement hydraulic hoses and fittings must have a minimum rated working pressure of 4000 psi.**

## DIRECT DRIVE POWER BOX RAKE FOR SKID-STEER LOADERS



**INCLUDES: POWER BOX RAKE AND UNIVERSAL SSL MOUNTING (HOSES AND COUPLERS INCLUDED FOR SKID-STEERS ONLY. TO ORDER: CHOOSE POWER BOX RAKE, MOUNTING, AND HYDRAULIC CONTROL AND WIRE HARNESS**

POWER BOX RAKE - DIRECT DRIVE SKID STEERS WITH A RATED OPERATING CAPACITY <5,000 LBS		ORDER CODE	SHIP WEIGHT (LBS)	LIST PRICE
<b>Power Box Rake - Direct Drive with Manual Angle</b>				
72" working width PowerRake		LAF5672-0022	1071	\$11,506
90" working width PowerRake		LAF5690-0022	1153	\$13,390
<b>Power Box Rake - Direct Drive with Hydraulic Angle Kit (factory installed)</b>				
72" working width PowerRake		LAF5672H-0022	1071	\$13,320
90" working width PowerRake		LAF5690H-0022	1153	\$15,588
<b>MOUNTING - ADDITIONAL COST MAY APPLY</b>		ORDER CODE	SHIP WEIGHT (LBS)	
Contact Customer Service at (833) 723-1843				
<b>HYDRAULIC CONTROL AND WIRE HARNESS OPTIONS</b>		ORDER CODE	SHIP WEIGHT (LBS)	
Control box w/ power lead		28-10754	5	\$383
Wire harness for CAT pre-B (8-pin Deutsch)		07-10021	5	\$372
Wire harness for CAT (14-pin "D" series)		07-8344	5	\$273
Wire harness for standard flow attachments on CAT B and C (8-pin Deutsch)		07-10122	5	\$346
Wire Harness (multi function in cab controls) for CNH, JCB, Bobcat, Mustang, Kubota, Takeuchi, Volvo 14 Pin-8 Pin		LAF9360-0000	5	\$268
Wire harness for CNH (8-pin rectangular)		LAF9393	5	\$222
Wire harness for John Deere (3-pin Deutsch)		07-7338	5	\$278
Wire harness for John Deere-8 button (14-pin Deutsch)		LAF9361	5	\$362
Wire harness for John Deere EH control (14-pin Deutsch)		07-7626	5	\$711
Wire harness for Komatsu (14-pin Deutsch)		07-10194	5	\$377
Wire harness for Komatsu (8-pin Deutsch)		07-10057	5	\$585
<b>Extension</b>				
60" extension		07-7887	2	\$133
<b>OPTIONAL - ADDITIONAL PARTS</b>		ORDER CODE	SHIP WEIGHT (LBS)	
Hydraulic angle kit f/72" & 90"		LAF5650-0000	35	\$2,799

# RAKES

## POWER BOX RAKE - DIRECT DRIVE CONT.

### DIRECT DRIVE POWER BOX RAKE FOR SKID-STEER LOADERS

REPLACEMENT PARTS	ORDER CODE	SHIP WEIGHT (LBS)	LIST PRICE
Carbide Tooth - All Models - Qty 1	M6774C		\$29
Carbide Tooth - All Models - Qty 3	M6774-3		\$75
Carbide Tooth - All Models - Qty 10	M3774-10		POR
ASSY TIRE/WHL/HUB/BRG/AXLE BOLT/SPACERS - Direct Drive Models	M16114		\$407
ASSY CASTER HUB - Direct Drive Models	M16120		\$255
Hydraulic Cylinder Swing Angle - Direct Drive Models	03-5724		\$608
Hydraulic Hose Supply & Return - Direct Drive M Models - Qty 1	LAF4680-0000		\$175
Hydraulic Hose Supply - Direct Drive H Models - Qty 1	LAF4680-0000		\$175
Hydraulic Hose Return - Direct Drive H Models - Qty 1	LAF4658-0000		\$96

Add Surcharge to all products 8.95%

## ROOT RAKE

**NEW PRODUCT**

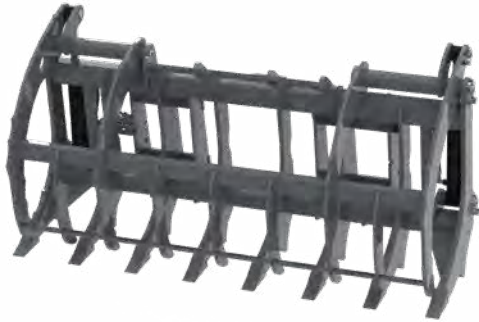

- Remove the soil and leave the soil
- Replaceable pin-on H&L-230 style teeth for durability and extended life
- Zinc plated, greaseable, pivot pins with protected grease zerks, and replaceable hardened steel bushings
- Comes standard with 85" hoses and 1/2" quick couplers

Specifications							
Rake Width	Width (overall Grapple)	Height (overall)	Grapple Opening	Tooth Position	Length (overall)	Weight (lbs) varies depending on mount	Tine Spacing
72"	70"	38.76"	51"	27"	31.72"	1110	10.13"
78"	70"	38.76"	51"	27"	31.72"	1130	10.13"
84"	70"	38.76"	51"	27"	31.72"	1225	10.13"

## ROOT RAKES FOR SKID-STEER LOADERS



ROOT RAKE	ORDER CODE	SHIP WEIGHT (LBS)	PRICE LIST
72" Root Rake Assembly	31972-0022	1110	\$7,900
78" Root Rake Assembly	31978-0022	1130	\$8,120
84" Root Rake Assembly	31984-0022	1225	\$8,440

REPLACEMENT PARTS	ORDER CODE	SHIP WEIGHT (LBS)	PRICE LIST
Bucket Tooth - HL23 Series, Cast	88893	3.2	\$24
Flex Pin	88894	0.1	\$10

ROOT RAKES CONTINUED NEXT PAGE

# RAKES

## ROOT RAKE CONT.

### ROOT RAKES FOR COMPACT TRACTORS



**INCLUDES: ROOT RAKE AND MOUNT AS INDICATED**

ROOT RAKE	ORDER CODE	SHIP WEIGHT (LBS)	LIST PRICE
60" Root Rake - Universal SSL Mount	109982	413	\$3,602
66" Root Rake - Universal SSL Mount	109983	439	\$3,688
72" Root Rake - JD400 Mount	113088	446	\$4,697
72" Root Rake - Pin-on Mount	112606	446	\$4,697
72" Root Rake - Universal SSL Mount	109984	448	\$4,008

HOSE KITS	ORDER CODE	SHIP WEIGHT (LBS)	LIST PRICE
76" hoses w/ .50" Flat Face Couplers	121151	15	\$432
84" hoses w/ .50" Flat Face Couplers	121152	18	\$454
96" hoses w/ .50" Flat Face Couplers and 90° fittings	121084	20	\$496

### ROOT RAKES FOR COMPACT WHEEL LOADERS



**INCLUDES: ROOT RAKE AND COMPACT WHEEL LOADER MOUNT**

ROOT RAKE	ORDER CODE	SHIP WEIGHT (LBS)	LIST PRICE
72" Root Rake Assembly for Takeuchi TW50-TW65-TW80 Combo Mount	107332	1200	\$8,184
72" Root Rake Assembly for JCB 406, 407 / CASE 321F / NH W50C / ZTL-Meyer 402 Mount	117036	1130	\$8,184
72" Root Rake Assembly for Case 221D / NH LW80	12843	1150	\$8,184
72" Root Rake Assembly for Volvo L30-35	124703	1150	\$7,871
78" Root Rake Assembly for Volvo L30	13179	1140	\$8,231
78" Root Rake Assembly for Kawasaki 45ZV-2	13391	1250	POR
84" Root Rake Assembly for Takeuchi TW65 - TW80	108125	1250	\$9,392
84" Root Rake Assembly for CAT IT / TH	120300	1250	\$9,393
84" Root Rake Assembly for JD244J / VOLVO L35	13269	1350	\$9,392

REPLACEMENT PARTS	ORDER CODE	SHIP WEIGHT (LBS)	LIST PRICE
Bucket Tooth - HL23 Series, Cast	88893	3.2	\$24
Flex Pin	88894	0.1	\$10

## ROOT RAKE CONT.

### ROOT RAKES FOR EURO/GLOBAL MOUNTS



**INCLUDES: ROOT RAKE AND MOUNT AS INDICATED**

ROOT RAKE	ORDER CODE	SHIP WEIGHT (LBS)	LIST PRICE
72" Root Rake Assembly - Euro Global Mount	114061	1100	\$8,451
84" Root Rake Assembly - Euro Global Mount	111410	1225	\$9,663

REPLACEMENT PARTS	ORDER CODE	SHIP WEIGHT (LBS)	LIST PRICE
Bucket Tooth - HL23 Series, Cast	88893	3.2	\$24
Flex Pin	88894	0.1	\$10

### ROOT RAKES FOR TRACTOR LOADERS/BACKHOES



**INCLUDES: ROOT RAKE AND UNIVERSAL SSL MOUNTING TO ORDER: CHOOSE ROOT RAKE AND HOSE KIT**



**IMPORTANT:** Due to the variances between different makes and models, Root Rakes for SSL do not include hoses and couplers. They must be ordered separately.

ROOT RAKE	ORDER CODE	SHIP WEIGHT (LBS)	LIST PRICE
84" Root Rake Assembly, QCP 7000/NH LB75B	12846	1475	\$9,213

HOSE KITS	ORDER CODE	SHIP WEIGHT (LBS)	LIST PRICE
76" hoses w/ .50" Flat Face Couplers	121151	15	\$432
84" hoses w/ .50" Flat Face Couplers	121152	18	\$454
96" hoses w/ .50" Flat Face Couplers and 90° fittings	121084	20	\$496

REPLACEMENT PARTS	ORDER CODE	SHIP WEIGHT (LBS)	LIST PRICE
Bucket Tooth - HL23 Series, Cast	88893	3.2	\$24
Flex Pin	88894	0.1	\$10

Add Surcharge to all products 8.85%

# ROCK SAWS

## ROCK SAW



- Steel planetary drive delivers high torque
- Standard electro-hydraulic controls, depth controls, and side-shift
- Protective shields for hydraulic & electrical components
- Solid hardened steel wheels with greasable manifold pins and secluded greased zerks

### Specifications

Model	Overall Width	Overall Length	Max Cut Depth	Wheel Dia.	Picks	Flow GPM	Weight w/o picks
RS18	67"	76"	18"	48"	42	22 to 44	1775 lbs
RS24	67"	86"	24"	60"	56	30 to 44	2095 lbs

## ROCK SAW FOR SKID-STEER LOADERS



**TO ORDER CHOOSE: ROCK SAW, HYDRAULIC MOTOR, PICK & HOLDERS, HYDRAULIC KIT AND CONTROLS**

HIGH FLOW WITH HYDRAULIC SIDE SHIFT	ORDER CODE	SHIP WEIGHT (LBS)	LIST PRICE
18" depth 22-44 GPM	106874	1775	\$22,004
24" depth minimum 30 GPM (24" requires a minimum of 2,500 lbs rated operating capacity)	106875	2095	\$22,057

HYDRAULIC MOTOR	ORDER CODE	SHIP WEIGHT (LBS)	LIST PRICE
22 to 28 GPM hydraulic motor not compatible with 106875	17776	25	\$3,144
29 to 35 GPM hydraulic motor	17777	21	\$3,334
36 to 44 GPM hydraulic motor	17778	25	\$3,488

PICK & HOLDERS	ORDER CODE	SHIP WEIGHT (LBS)	LIST PRICE
18" x 2.5" wide general purpose pick	106681	220	\$3,000
18" x 4.0" wide general purpose pick	106682	245	\$2,676
24" x 2.5" wide general purpose pick	106684	290	\$3,718
24" x 4.0" wide general purpose pick	106685	325	\$3,791

HYDRAULIC KIT	ORDER CODE	SHIP WEIGHT (LBS)	LIST PRICE
88" hoses .50" flat face couplers	106876	28	\$680
106" hoses .50" flat face couplers	106877	32	\$652
88" hoses .625" flat face couplers	106878	28	\$579
106" hoses .625" flat face couplers	106879	32	\$682
88" hoses .75" flat face couplers	106880	28	\$728
106" hoses .75" flat face couplers	106881	32	\$794
Hose extension kit	119419	15	\$367

ROCK SAW CONTINUED NEXT PAGE

## ROCK SAW

### ROCK SAW FOR SKID-STEER LOADERS CONT.



HYDRAULIC CONTROL AND WIRE HARNESS OPTIONS (MUST CHOOSE ONE)	ORDER CODE	SHIP WEIGHT (LBS)	LIST PRICE
Control box w/ power lead	28-10754	5	\$383
Wire harness for CAT (14-pin "D" series)	07-8344	5	\$273
Wire harness for CAT pre-B (8-pin Deutsch)	07-10021	5	\$372
Wire harness for standard flow attachments on CAT B and C (8-pin Deutsch)	07-10122	5	\$346
Wire harness for John Deere-8 button (14-pin Deutsch)	LAF9361	5	\$362
Wire harness for John Deere EH control (14-pin Deutsch)	07-7626	5	\$711
Wire harness for John Deere (3-pin Deutsch)	07-7338	5	\$278
Wire harness for Komatsu (14-pin Deutsch)	07-10194	5	\$377
Wire harness for Komatsu (8-pin Deutsch)	07-10057	5	\$585
Wire Harness (multi function in cab controls) for CNH, JCB, Bobcat, Mustang, Kubota, Takeuchi, Volvo 14 Pin-8 Pin	LAF9360-0000	5	\$268
Wire harness for CNH (8-pin rectangular)	LAF9393	5	\$222

OPTIONAL - WATER KIT	ORDER CODE	SHIP WEIGHT (LBS)	LIST PRICE
Water nozzle kit for rock saw	112620	8	\$557
30gal Universal mount tank, 12v pump, with electrical control box	104444	65	\$2,754
30gal Universal mount tank, 12v pump, without electrical control box	105720	60	\$2,204

REPLACEMENT PARTS	ORDER CODE	SHIP WEIGHT (LBS)	LIST PRICE
<b>Replacement Picks</b>			
50 concrete picks	102059	30	\$988
50 general purpose picks	102058	30	\$788

Add Surcharge to all products 8.85%

# SILAGE DEFACER

## SILAGE DEFACER



- Designed to remove hay & corn silage from tightly compacted bunkers
- 96" cutting width to cut next to walls and straight through to back of bunker
- Adjustable guides for depth of cut
- 0 to 19 ft. working height

### Specifications

Overall Length	Reach	Fixed Depth
8'	10'	0" to 3"

## SILAGE DEFACER FOR SKID-STEER LOADERS



	ORDER CODE	SHIP WEIGHT (LBS)	LIST PRICE
silage defacer 18 to 22 GPM	16980	940	\$10,089
silage defacer short mount for skid steer loaders	103791	790	\$9,809

## SILAGE DEFACER FOR EURO-GLOBAL MOUNTS



	ORDER CODE	SHIP WEIGHT (LBS)	LIST PRICE
silage defacer with euro / global mount	108343	870	\$10,125

## SILAGE DEFACER FOR TELEHANDLERS



	ORDER CODE	SHIP WEIGHT (LBS)	LIST PRICE
Bobcat	12894	1130	\$10,125
Cat IT/TH	12425	1130	\$10,201
JCB Q-fit & New Holland Q-fit	12364	1130	\$10,125
K-D Manitou	12686	1130	\$10,125
JCB G Series (with serial # <0160037670)	13253	1130	\$10,125

## SKID HOE/SWING HOE



- Fixed or swing configurations available
- Bucket curl feature
- 12", 16", 18" & 24" buckets available

Specifications					
Model	Weight (approx)	Width	Overall Reach	Digging Depth	Digging Force
111637 (fixed)	395 lbs	47.5"	75"	73"	3,895 lbs
112140 (swing)	535 lbs	47.5"	78"	76"	3,800 lbs



**IMPORTANT:** Some skid steer models require a tilt circuit hydraulic relief valve. This cartridge is **IN ADDITION TO THE EXISTING RELIEF CARTRIDGE** and is required to protect the circuit of the skid steer. Failure to install the cartridge when required can result in damage to the skid steer and will **VOID** all Bradco warranties. **CASE:** Models 1845C and XT units require no additional relief. **DEERE:** Models 4475, 5575, 6675, 7775 and 8875 require JD cartridge (JD part# MG86529091). Models 240, 250, 260, and 270 control valve **EXCEPT** for models with serial numbers greater than 440001 (JD240), 450001 (JD250), 460001 (JD260), 470001 (JD270) and 480001 (JD280), which require no additional relief. **BOBCAT:** Units with BICS do not require relief. Units without BICS but with a plug and relief on the tilt spool, require Bobcat part #6599161 to replace the plug. **GEHL:** Models 7600 and 7800 and **MUSTANG 2095 and 2105** install Gehl part #138703. **NEW HOLLAND:** Install relief cartridge (NH part #86529091).

## SKID HOE/SWING HOE FOR SKID-STEER LOADERS



**TO ORDER: CHOOSE ATTACHMENT AND BUCKET**

FIXED SKID BACKHOE ASSEMBLY			
	ORDER CODE	SHIP WEIGHT (LBS)	LIST PRICE
skid hoe assembly (fixed)	111637	305	\$3,353
swing hoe	112140	550	\$6,074
BUCKETS (ONE REQUIRED)			
	ORDER CODE	SHIP WEIGHT (LBS)	LIST PRICE
<b>Bucket Width</b>			
12" standard (3 teeth)	81712	76	\$866
16" standard (4 teeth)	81716	89	\$993
18" standard (4 teeth)	81718	95	\$1,040
24" standard (5 teeth)	81724	115	\$1,086
OPTIONS			
	ORDER CODE	SHIP WEIGHT (LBS)	LIST PRICE
adjustable thumb kit (factory installed)	110680	67	\$958
adjustable thumb kit (dealer installed)	108571	67	\$723
<b>In Cab Controls (required for control of swing hoe (second function))</b>			
electrical control box required if skid steer is NOT equipped with attachment electrical controls	15756	10	\$676
14 pin Case, New Holland, Volvo, Ditch Witch	25887	5	\$551
3 pin John Deere	25885	5	\$519
14 pin John Deere Standard	25904	5	\$552
8 pin ASV, CAT, Komatsu	25886	5	\$551
14 pin Bobcat	110627	5	\$552

Add Surcharge to all products 8.85%

# SNOW REMOVAL



# SNOW REMOVAL

## ICESHARK SNOW BLOWERS



- The new patented backdrag options allows operators to remove snow as close as 6" from a garage or wall to minimize the amount of shoveling required
- The built in yellow indicators guide users as they get close to a structure and give the operator guidance before engaging the backdrag functionality
- The new 3D floating hitch offers side to side, up and down, and front to back motion to allow the snow blower to have the smoothest operating experience when working on uneven surfaces
- The 3D floating hitch also allows for an uninterrupted scrape offering a cleaner surface which means less salt is required
- The dual articulating shoot offering unprecedented user control on where to place the snow with the 270 degrees of motion and ability to blow snow from as close as 3 feet or up to 45 feet
- The skid skis offer toolless adjustment which enable users to quickly and easily transition from gravel to pavement

SPECIFICATIONS	Compact & Standard Flow				High Flow	
	48"	60"	72"	84"	72"	84"
Overall Length without Backdrag	46"	46"	46"	46"	49.3"	49.3"
Overall Length with Backdrag*	-	57.8"	57.8"	57.8"	61.3"	61.3"
Overall Width	53"	65"	77"	89"	77"	89"
Maximum Overall Height	71"	71"	71"	71"	78"	78"
Minimum Overall Height	60"	60"	60"	60"	65.75"	65.75"
Cutting Width	48"	60"	72"	84"	72"	84"
Cutting Height	27.5"	27.5"	27.5"	27.5"	34"	34"
Hydraulic Pressure	3500 PSI				4200 PSI	

\*Backdrag not available in 48" models

## SNOW BLOWERS FOR SKID-STEER LOADERS



SNOW BLOWER	ORDER CODE	SHIP WEIGHT (LBS)	LIST PRICE
<b>CHECK LOADER CAPACITY BEFORE ORDERING</b>			
<b>CONTROL BOX/HARNESS NOT INCLUDED - MUST ORDER SEPARATELY</b>			
<b>Compact Flow</b>			
48" Compact-Flow Snow Blower w/ GPM Range 8-15, No Backdrag	25048B-0022	820	\$10,566
<b>Standard Flow</b>			
60" Standard-Flow Snow Blower w/GPM Range 15-27, No Backdrag	25060D-0022	860	\$11,870
60" Standard-Flow Snow Blower w/GPM Range 15-27, Backdrag Included	25060DBD-0022	1020	\$14,482
72" Standard-Flow Snow Blower w/GPM Range 15-27, No Backdrag	25072D-0022	905	\$12,563
72" Standard-Flow Snow Blower w/GPM Range 15-27, Backdrag Included	25072DBD-0022	1070	\$15,175
84" Standard-Flow Snow Blower w/GPM Range 15-27, No Backdrag	25084D-0022	945	\$13,729
84" Standard-Flow Snow Blower w/GPM Range 15-27, Backdrag Included	25084DBD-0022	1120	\$16,341

SNOW BLOWERS CONTINUED NEXT PAGE

## ICESHARK SNOW BLOWERS

### SNOW BLOWERS FOR SKID-STEER LOADERS CONT.

SNOW BLOWER CONT.	ORDER CODE	SHIP WEIGHT (LBS)	LIST PRICE
<b>High-Flow Snow Blower</b>			
72" High-Flow Snow Blower w/GPM Range 27-35, No Backdrag	25072F-0022	1030	\$13,500
72" High-Flow Snow Blower w/GPM Range 27-35, Backdrag Included	25072FBD-0022	1200	\$16,112
84" High-Flow Snow Blower w/GPM Range 27-35, No Backdrag	25084F-0022	1080	\$14,500
84" High-Flow Snow Blower w/GPM Range 27-35, Backdrag Included	25084FBD-0022	1260	\$17,112
<b>Extra High-Flow Snow Blower</b>			
72" Extra High-Flow Snow Blower w/GPM Range 35-45, No Backdrag	25072H-0022	1045	\$14,950
72" Extra High-Flow Snow Blower w/GPM Range 35-45, Backdrag Included	25072HBD-0022	1220	\$17,562
84" Extra High-Flow Snow Blower w/GPM Range 35-45, No Backdrag	25084H-0022	1090	\$16,000
84" Extra High-Flow Snow Blower w/GPM Range 35-45, Backdrag Included	25084HBD-0022	1280	\$18,612

HYDRAULIC CONTROL AND WIRE HARNESS OPTIONS (MUST CHOOSE ONE)	ORDER CODE	SHIP WEIGHT (LBS)	LIST PRICE
Standard Control Box - 3-function in 2 direction (3 switch)	07-10013	1	\$536
Control box with power lead - 2-function in 2 direction (2 switch)	LAF9394-0000	5	\$355
Wire harness for CAT pre-B (8-pin Deutsch)	07-10021	5	\$372
Wire harness for standard flow attachments on CAT B and C (8-pin Deutsch)	07-10122	5	\$346
Control box with wire harness for high flow attachments on CAT B and C (8-pin Deutsch)	07-10170	5	\$553
Wire harness for selectable joystick controls (7-pin for Bobcat)	07-9548	1	\$985
Wire harness for CAT (14-pin "D" series)	07-8344	1	\$273
Wire Harness (multi function in cab controls) for CNH, JCB, Bobcat, Mustang, Kubota, Takeuchi, Volvo 14 Pin-8 Pin	LAF9360-0000	5	\$268
Wire harness for CNH (8-pin rectangular)	LAF9393	5	\$222
Wire harness for John Deere (3-pin Deutsch)	07-7338	5	\$278
Wire harness for John Deere EH control (14-pin Deutsch)	07-7626	5	\$711
Wire harness for Komatsu (14-pin Deutsch)	07-10194	5	\$377
Wire harness for Komatsu (8-pin Deutsch)	07-10057	5	\$585

REPLACEMENT PARTS (INCLUDE HARDWARE)	ORDER CODE	SHIP WEIGHT (LBS)	LIST PRICE
48" Steel Edge Kit	28-11300-48		\$115
60" Steel Edge Kit	28-11300-60		\$132
72" Steel Edge Kit	28-11300-72		\$185
84" Steel Edge Kit	28-11300-84		\$188
48" Polyurethane Edge Kit	28-11301-48		\$437
60" Polyurethane Edge Kit	28-11301-60		\$509
72" Polyurethane Edge Kit	28-11301-72		\$656
84" Polyurethane Edge Kit	28-11301-84		\$738
Steel Wear Shoe Kit	28-11312		\$230
Soft Wear Shoe Kit	28-11313		\$412
Kit Service Supply/Return Hoses/Ftgs HF/XHF	28-11341		\$766
Kit Service Supply/Return Hoses/Ftgs SF/LF	28-11342		POR
Kit Service QD 1/2" ISO 16028 (1 M & 1 F)	28-9570		\$151
Kit Service Chute Rotation Motor	28-11302		\$787
Kit Service Impeller LF Motor (Motor & Hardware)	28-11305		POR
Kit Service Impeller SF Motor (Motor & Hardware)	28-11306		POR
Kit Service Impeller HF Motor (Motor & Hardware)	28-11303		\$1,289
Kit Service Impeller XHF Motor (Motor & Hardware)	28-11304		POR
Kit Service Auger LF Motor (Motor & Hardware)	28-11308		POR
Kit Service Auger SF Motor (Motor & Hardware)	28-11309		\$1,136
Kit Service Auger XHF/HF Motor (Motor & Hardware)	28-11307		\$1,295
Kit Seal Impeller/Auger Motor (Motor & Hardware)	LAF4572-0000		\$221

SNOW BLOWER OPTIONS CONTINUED NEXT PAGE

# SNOW REMOVAL

## ICESHARK SNOW BLOWERS

### SNOW BLOWERS FOR SKID-STEER LOADERS CONT.

SNOW REMOVAL

OPTIONS	ORDER CODE	SHIP WEIGHT (LBS)	LIST PRICE
Backdrag Kit, 60" Standard-Flow	28-11225-60		\$2,830
Backdrag Kit, 72" Standard-Flow	28-11225-72		\$2,830
Backdrag Kit, 84" Standard-Flow	28-11225-84		\$2,830
Backdrag Kit, 72" High-Flow, Extra High-Flow	28-11219-72		\$2,830
Backdrag Kit, 84" High-Flow, Extra High-Flow	28-11219-84		\$2,830

EXTENDED HOSE KITS (FOR JCB AND VOLVO SKID STEERS)	ORDER CODE	SHIP WEIGHT (LBS)	LIST PRICE
20" SF Extended Hose Kits	28-11367		\$277
30" HF Extended Hose Kits	28-11368		\$395

## SNOW BLADES

### 114 SERIES SNOW BLADES



- Hydraulically or manually angles 30° in either direction
- Reversible, replaceable wear edge, optional rubber edge
- Adjustable skid shoes
- Spring-loaded trip mechanism
- 7-gauge steel blade

Carrier Specifications	
Lift Capacity	Operating Weight
<5,000 lbs.	<8,000 lbs.

Specifications				
Model	Weight (approx)	Width OD	Height OD	Cutting Width @ Max Angle
11460	510 lbs	60"	23"	52"
11472	595 lbs	72"	23"	62"
11484	635 lbs	84"	23"	73"
11496	650 lbs	96"	23"	83"



**IMPORTANT:** The LAF114 Series Snow Blade is for all skid steer and utility loader models up to 80 hp. Locking bolts (part # RHW8063-0000) are included for light dirt-moving for skid steers only. All replacement hydraulic hoses and fittings must have a minimum rated working pressure of 4000 psi.

SNOW BLADES CONTINUED NEXT PAGE

## SNOW BLADES CONT.

### 114 SERIES SNOW BLADES CONT.



**INCLUDES: STEEL SNOW BLADE, UNIVERSAL SSL MOUNTING, HOSES AND COUPLERS**  
**TO ORDER: CHOOSE SNOW BLADE AND MOUNT, DENOTE DESIRED ANGLE TYPE WHEN ORDERING**

SNOW BLADE CHECK LOADER CAPACITY BEFORE ORDERING	ORDER CODE	SHIP WEIGHT (LBS)	LIST PRICE
<b>114 Series - Manual Angle</b>			
60" manual angle snow blade	11460M-0022	510	\$4,335
72" manual angle snow blade	11472M-0022	595	\$4,539
84" manual angle snow blade	11484M-0022	635	\$4,575
96" manual angle snow blade	11496M-0022	650	\$4,695
<b>114 Series - Hydraulic Angle</b>			
60" hydraulic angle snow blade	11460-0022	510	\$3,873
72" hydraulic angle snow blade	11472-0022	595	\$3,926
84" hydraulic angle snow blade	11484-0022	635	\$4,023
96" hydraulic angle snow blade	11496-0022	650	\$4,125

MOUNTING - ADDITIONAL COST MAY APPLY	ORDER CODE	SHIP WEIGHT (LBS)
Contact Customer Service at (833) 723-1843		
114 SERIES SNOW BLADES CONTINUED NEXT PAGE		

OPTIONS - REPLACEMENT PARTS	ORDER CODE	SHIP WEIGHT (LBS)	LIST PRICE
<b>Replacement edges - Steel and Rubber with hardware</b>			
<b>Optional Rubber Edge Kit</b>			
rubber edge for 11460 snow blade	LAF6485-0000	43	POR
rubber edge for 11472 snow blade	LAF6486-0000	52	POR
rubber edge for 11484 snow blade	LAF6487-0000	59	\$1,155
rubber edge for 11496 snow blade	LAF6488-0000	67	\$1,261
<b>Replaceable Steel Edge Kit</b>			
steel edge for 11460 snow blade	FFC10105	32	POR
steel edge for 11472 snow blade	FFC10106	39	\$284
steel edge for 11484 snow blade	FFC10107	45	\$322
steel edge for 11496 snow blade	FFC10108	51	\$343
<b>Angle Kits</b>			
manual angle kit for snow blade 1400 series	FFC10014	10	\$301
hydraulic angle kit for snow blade 1400 series	FFC10049	18	\$1,097

# SNOW REMOVAL

## SNOW BLADES

### 115 SERIES SNOW BLADES



- Hydraulically angles 35° in either direction
- Replaceable bolt-on wear edge.
- Optional rubber edge
- Skid shoes with adjustable height
- Reinforced 7-gauge steel blade
- Spring-loaded trip mechanism

Carrier Specifications	
Lift Capacity	Operating Weight
<10,000 lbs.	<20,000 lbs.

**!** **IMPORTANT:** Check capacity and limits of skid steer or loader before ordering. Add 1 foot to the carrier width when sizing a blade. All replacement hydraulic hoses and fittings must have a minimum rated working pressure of 4000 psi.

Specifications				
Model	Weight (approx)	Width	Height	Cutting Width @ 35° Angle
11584	1125 lbs	84"	32"	69"
11596	1180 lbs	96"	32"	79"
11508	1235 lbs	108"	32"	88"
11520	1315 lbs	120"	32"	98"
11532	1375 lbs	132"	32"	108"
11544	1435 lbs	144"	32"	118"

### 115 SERIES SNOW BLADES FOR SKID-STEER LOADERS AND TRACTOR LOADERS/BACKHOES



**i** **INCLUDES: STEEL SNOW BLADE AND UNIVERSAL SSL MOUNTING. HOSES AND COUPLERS INCLUDED FOR SKID-STEER LOADERS ONLY. TO ORDER: CHOOSE SNOW BLADE AND MOUNT, DENOTE DESIRED ANGLE TYPE WHEN ORDERING**

SNOW BLADE CHECK LOADER CAPACITY BEFORE ORDERING	ORDER CODE	SHIP WEIGHT (LBS)	LIST PRICE
84" snow blade	11584-0022	1186	\$5,679
96" snow blade	11596-0022	1232	\$5,679
108" snow blade	11508-0022	1309	\$5,750
120" snow blade	11520-0022	1393	\$5,811
132" snow blade	11532-0022	1473	\$7,098
144" snow blade	11544-0022	1558	\$8,209

MOUNTING - ADDITIONAL COST MAY APPLY	ORDER CODE	SHIP WEIGHT (LBS)
Contact Customer Service at (833) 723-1843		

Standardized mounting with the exception of ACS, CAT Fusion and Bobcat X-Change

OPTIONS - REPLACEMENT PARTS	ORDER CODE	SHIP WEIGHT (LBS)	LIST PRICE
Marker Kit	11601	5	\$185

115 SERIES SNOW BLADES CONTINUED NEXT PAGE

## SNOW BLADES CONT.

### 115 SERIES SNOW BLADES CONT.

Replacement edges - Steel and Rubber with hardware	ORDER CODE	SHIP WEIGHT (LBS)	LIST PRICE
<b>Optional Rubber Edge Kit</b>			
rubber edge for 11584 snow blade	LAF1551-0000	123	\$988
rubber edge for 11596 snow blade	LAF1552-0000	134	\$1,555
rubber edge for 11508 snow blade	LAF1553-0000	145	\$1,655
rubber edge for 11520 snow blade	LAF1554-0000	155	\$1,755
rubber edge for 11532 snow blade	LAF1555-0000	166	\$1,983
rubber edge for 11544 snow blade	LAF1556-0000	176	\$1,729
<b>Replaceable Steel Edge Kit</b>			
steel edge for 11584 snow blade	10117	160	\$916
steel edge for 11596 snow blade	10118	176	POR
steel edge for 11508 snow blade	10119	192	\$972
steel edge for 11520 snow blade	10120	207	POR
steel edge for 11532 snow blade	10121	223	\$1,060
steel edge for 11544 snow blade	10122	239	\$1,159
<b>Polyurethane Edge Kit</b>			
polyurethane edge for 11584 snow blade	28-10755-84	60	\$1,748
polyurethane edge for 11596 snow blade	28-10755-96	65	\$2,035
polyurethane edge for 11508 snow blade	28-10755-108	70	\$2,270
polyurethane edge for 11520 snow blade	28-10755-120	75	POR
polyurethane edge for 11532 snow blade	28-10755-132	80	\$829
polyurethane edge for 11544 snow blade	28-10755-144	85	\$1,013
<b>Top Flap - Reduces Snow Spillage</b>			
top flap for 11584 snow blade	LAF6492-0000	62	\$260
top flap for 11596 snow blade	LAF6493-0000	64	\$351
top flap for 11508 snow blade	LAF6494-0000	66	\$559
top flap for 11520 snow blade	LAF6495-0000	68	\$338
top flap for 11532 snow blade	LAF6497-0000	70	\$338
top flap for 11544 snow blade	LAF6498-0000	72	\$784
<b>Hydraulic Cushion Kit - Protects damage to cylinders</b>			
hydraulic cushion kit <i>(Included on ALL newly purchased models 120" wide and larger)</i>	28-10447	10	\$531

# SNOW REMOVAL

## SNOW BLADES

### 5700 SERIES SNOW BLADES



- Hydraulically angles 30° in either direction
- Replaceable bolt-on wear edge. Optional rubber edge
- Skid shoes with adjustable height
- Reinforced 7-gauge steel blade
- Spring-loaded trip mechanism

Carrier Specifications	
Lift Capacity	Operating Weight
<9,000 lbs.	<11,000 lbs.



**IMPORTANT:** All replacement hydraulic hoses and fittings must have a minimum rated working pressure of 4000 psi.

Specifications				
Model	Weight (approx)	Width	Height	Cutting Width @ 30° Angle
LAF5784	875 lbs	84"	32"	73"
LAF5796	930 lbs	96"	32"	83"
LAF5708	890 lbs	108"	32"	93"
LAF5720	1065 lbs	120"	32"	104"
LAF5744	1185 lbs	144"	32"	125"

### 5700 SERIES SNOW BLADES FOR SKID-STEER LOADERS AND TRACTOR LOADERS/BACKHOES



**INCLUDES: SNOW BLADE AND UNIVERSAL SSL MOUNTING. HOSES AND COUPLERS INCLUDED FOR SKID-STEERS ONLY. TO ORDER: CHOOSE SNOW BLADE AND MOUNT**

SNOW BLADE	ORDER CODE	SHIP WEIGHT (LBS)	LIST PRICE
<b>CHECK LOADER CAPACITY BEFORE ORDERING</b>			
84" Snow Blade	LAF5784-0022	935	\$6,800
96" Snow Blade	LAF5796-0022	995	\$6,845
108" Snow Blade	LAF5708-0022	1060	\$7,010
120" Snow Blade includes Hydraulic Cushion Kit required on plows 120" and larger	LAF5720-0022	1140	\$8,166
144" Snow Blade includes Hydraulic Cushion Kit required on plows 120" and larger	LAF5744-0022	1275	\$10,147

MOUNTING - ADDITIONAL COST MAY APPLY	ORDER CODE	SHIP WEIGHT (LBS)
Contact Customer Service at (833) 723-1843		
115 SERIES SNOW BLADES CONTINUED NEXT PAGE		

## SNOW BLADES

### 5700 SERIES SNOW BLADES CONT.

OPTIONS - REPLACEMENT PARTS	ORDER CODE	SHIP WEIGHT (LBS)	LIST PRICE
<b>Replacement edges - Steel and Rubber with hardware</b>			
<b>Optional Rubber edge Kit</b>			
rubber edge for LAF5784 snow blade	LAF1551-0000	123	\$988
rubber edge for LAF5796 snow blade	LAF1552-0000	134	\$1,555
rubber edge for LAF5708 snow blade	LAF1553-0000	145	\$1,655
rubber edge for LAF5720 snow blade	LAF1554-0000	155	\$1,755
rubber edge for LAF5744 snow blade	LAF1556-0000	176	\$1,729
<b>Replacement edges - Steel and Rubber with hardware</b>			
<b>Replaceable steel edge Kit</b>			
steel edge for LAF5784 snow blade	10117	160	\$916
steel edge for LAF5796 snow blade	10118	176	\$856
steel edge for LAF5708 snow blade	10119	196	\$972
steel edge for LAF5720 snow blade	10120	207	\$1,020
steel edge for LAF5744 snow blade	10122	239	\$1,159
<b>Polyurethane Edge Kit</b>			
polyurethane edge for LAF5784 snow blade	28-10755-84	60	\$1,748
polyurethane edge for LAF5796 snow blade	28-10755-96	65	\$2,035
polyurethane edge for LAF5708 snow blade	28-10755-108	70	\$2,270
polyurethane edge for LAF5720 snow blade	28-10755-120	75	POR
polyurethane edge for LAF5744 snow blade	28-10755-144	85	POR
<b>Top Flap (reduces snow spillage)</b>			
top flap for LAF5784 snow blade	LAF6492-0000	62	POR
top flap for LAF5796 snow blade	LAF6493-0000	64	\$351
top flap for LAF5708 snow blade	LAF6494-0000	66	\$559
top flap for LAF5720 snow blade	LAF6495-0000	68	POR
top flap for LAF5744 snow blade	LAF6498-0000	72	\$784
<b>Hydraulic Cushion Kit (protects damage to cylinders)</b>			
Hydraulic Cushion Kit (Included on ALL newly purchased models 120" wide and greater)	28-10446	10	\$935

# SNOW REMOVAL

## SNOW BLADES

### 120 SERIES V-BLADE



- Available in seven blade widths
- Available with hydraulic sequencing valve or electro-hydraulic valve for independent blade function
- Adjustable Blade allows for straight, V or scoop positions
- Angles up to 30° in both directions
- Reversible cutting edge designed with spring loaded trip mechanism
- Blade floats 5° and tilts 5° for ground contour

#### Specifications

Model	Weight (Approx)	Height	Width (Straight)	Cutting Width at Full "V"	Cutting Width at Full "Scoop"	Cutting Width at Max Angle (30°)
12050	830 lbs	32.5"	48"	45.5"	37.5"	41.5"
12060	865 lbs	32.5"	60"	56"	48"	52"
12072	920 lbs	32.5"	72"	66.5"	58.5"	62.5"
12084	975 lbs	32.5"	84"	77"	69"	73"
12096	1020 lbs	32.5"	96"	87.5"	79.5"	83.5"
12008	1060 lbs	32.5"	108"	98"	90"	94"
12020	1110 lbs	32.5"	120"	108"	100.5"	104"



**IMPORTANT:** Check capacity and limits of carrier before ordering. Add 1 foot to the carrier width when sizing a blade. All replacement hydraulic hoses and fittings must have a minimum rated working pressure of 4000 psi.

## 120 SERIES V-BLADE FOR SKID-STEER LOADERS AND COMPACT WHEEL LOADERS



**PRICE INCLUDES: STEEL SNOW BLADE AND UNIVERSAL SSL MOUNTING. HOSES & COUPLERS INCLUDED FOR SKID-STEERS ONLY. TO ORDER: CHOOSE SNOW BLADE, MOUNT AND HYDRAULIC CONTROL**

SNOW BLADE CHECK LOADER CAPACITY BEFORE ORDERING	ORDER CODE	SHIP WEIGHT (LBS)	LIST PRICE
48" V-Snow Blade, hydraulic only controls	12050-0022	830	\$7,033
60" V-Snow Blade, hydraulic only controls	12060-0022	925	\$8,971
72" V-Snow Blade, hydraulic only controls	12072-0022	980	POR
84" V-Snow Blade, hydraulic only controls	12084-0022	1040	\$9,350
96" V-Snow Blade, hydraulic only controls	12096-0022	1090	\$8,750
108" V-Snow Blade, hydraulic only controls	12008-0022	1145	\$10,050
120" V-Snow Blade, hydraulic only controls	12020-0022	1190	\$10,326
48" V-Snow Blade, hydraulic/electric controls	12050E-0022	830	\$10,050
60" V-Snow Blade, hydraulic/electric controls	12060E-0022	925	POR
72" V-Snow Blade, hydraulic/electric controls	12072E-0022	980	POR
84" V-Snow Blade, hydraulic/electric controls	12084E-0022	1040	\$12,426
96" V-Snow Blade, hydraulic/electric controls	12096E-0022	1090	\$12,750
108" V-Snow Blade, hydraulic/electric controls	12008E-0022	1145	\$12,950
120" V-Snow Blade, hydraulic/electric controls	12020E-0022	1190	POR

120 SERIES V-BLADE CONTINUED NEXT PAGE

## SNOW BLADES

### 120 SERIES V-BLADE CONT.

HYDRAULIC CONTROL AND WIRE HARNESS OPTIONS (MUST CHOOSE ONE)			
	ORDER CODE	SHIP WEIGHT (LBS)	LIST PRICE
Control box with power lead - 2-function in 2 direction (2 switch) - 12V	LAF9394-0000	5	\$355
Wire harness for CAT pre-B (8-pin Deutsch)	07-10021	5	\$372
Wire harness for standard flow attachments on CAT B and C (8-pin Deutsch)	07-10122	5	\$346
Control box with wire harness for high flow attachments on CAT B and C (8-pin Deutsch)	07-10170	5	\$553
Wire harness for selectable joystick controls (7-pin for Bobcat)	07-9548	1	\$985
Wire harness for CAT (14-pin "D" series)	07-8344	1	\$273
Wire Harness (multi function in cab controls) for CNH, JCB, Bobcat, Mustang, Kubota, Takeuchi, Volvo 14 Pin-8 Pin	LAF9360-0000	5	\$268
Wire harness for CNH (8-pin rectangular)	LAF9393	5	\$222
Wire harness for John Deere (3-pin Deutsch)	07-7338	5	\$278
Wire harness for John Deere EH control (14-pin Deutsch)	07-7626	5	\$711
Wire harness for John Deere P-Tier EH control (14-pin Deutsch)	07-9617	5	\$478
Wire harness for Komatsu (14-pin Deutsch)	07-10194	5	\$377
Wire harness for Komatsu (8-pin Deutsch)	07-10057	5	\$585

OPTIONS - REPLACEMENT PARTS			
	ORDER CODE	SHIP WEIGHT (LBS)	LIST PRICE
<b>Optional Polyurethane Edge Kit</b>			
polyurethane edge Kit for 12050 & 12050E V-Blade	28-10646-50	70	\$700
polyurethane edge Kit for 12060 & 12060E V-Blade	28-10646-60	75	\$765
polyurethane edge Kit for 12072 & 12072E V-Blade	28-10646-72	80	\$855
polyurethane edge Kit for 12084 & 12084E V-Blade	28-10646-84	85	\$1,088
polyurethane edge Kit for 12096 & 12096E V-Blade	28-10646-96	90	\$1,088
polyurethane edge Kit for 12008 & 12008E V-Blade	28-10646-108	95	\$1,124
polyurethane edge Kit for 12020 & 12020E V-Blade	28-10646-120	100	\$1,525
<b>Deflector Kit - Reduces Snow Spillage</b>			
deflector kit for 12050 & 12050E V-Blade	28-10717-50	35	POR
deflector kit for 12060 & 12060E V-Blade	28-10717-60	40	\$467
deflector kit for 12072 & 12072E V-Blade	28-10717-72	45	POR
deflector kit for 12084 & 12084E V-Blade	28-10717-84	50	POR
deflector kit for 12096 & 12096E V-Blade	28-10717-96	55	POR
deflector kit for 12008 & 12008E V-Blade	28-10717-108	60	\$569
deflector kit for 12020 & 12020E V-Blade	28-10717-120	65	\$590
<b>Replacement Steel Edge Kit</b>			
steel edge Kit for 12050 & 12050E V-Blade	28-10645-50	95	\$545
steel edge Kit for 12060 & 12060E V-Blade	28-10645-60	105	\$575
steel edge Kit for 12072 & 12072E V-Blade	28-10645-72	115	\$615
steel edge Kit for 12084 & 12084E V-Blade	28-10645-84	125	\$645
steel edge Kit for 12096 & 12096E V-Blade	28-10645-96	135	\$675
steel edge Kit for 12008 & 12008E V-Blade	28-10645-108	145	\$983
steel edge Kit for 12020 & 12020E V-Blade	28-10645-120	155	\$745
Marker Kit	11601	5	\$185
<b>Hydraulic Only Control to Hydraulic/Electric Conversion Kit</b>			
Conversion Kit	28-10705	20	\$1,549

# SNOW REMOVAL

## SNOW BUCKETS



- Moves large volumes of snow or other loose materials efficiently
- Cut out back plate for better visibility
- Quickly attaches to all skid-steer, backhoe, utility loader and small wheel loader brands
- Optional bolt-on edge available

Carrier Specifications	
Medium Duty Bucket	
Lift Capacity	Operating Weight
<5,000 lbs.	<8,000 lbs.

Heavy Duty Bucket	
Lift Capacity	Operating Weight
<9,500 lbs.	<11,000 lbs.

Specifications							
Model	Weight Approx	Width	Height	Depth	Leading Edge	Capacity Struck	Capacity Heaped
11184	733 lbs	84"	29.9"	42.0"	29.7"	1.14 yd <sup>3</sup>	1.47 yd <sup>3</sup>
11196	795 lbs	96"	29.9"	42.0"	29.7"	1.31 yd <sup>3</sup>	1.70 yd <sup>3</sup>
11197	999 lbs	96"	37.6"	46.2"	32.5"	1.83 yd <sup>3</sup>	2.36 yd <sup>3</sup>
11101	820 lbs	101.5"	29.9"	42.0"	29.7"	1.40 yd <sup>3</sup>	1.82 yd <sup>3</sup>
11102	1020 lbs	101.5"	37.6"	46.2"	32.5"	1.95 yd <sup>3</sup>	2.52 yd <sup>3</sup>
11108	1078 lbs	108"	37.6"	46.2"	32.5"	2.07 yd <sup>3</sup>	2.67 yd <sup>3</sup>

### SNOW BUCKETS FOR SKID-STEER LOADERS



**INCLUDES: SNOW BUCKET, BOLT ON EDGE, AND UNIVERSAL SSL MOUNTING  
TO ORDER: CHOOSE SNOW BUCKET AND MOUNT**

SNOW BUCKET CHECK LOADER CAPACITY BEFORE ORDERING	ORDER CODE	SHIP WEIGHT (LBS)	LIST PRICE
<b>Medium-Duty Snow Bucket</b>			
84" OD Medium-Duty Snow Bucket (BOE Included)	11184-0022	733	\$3,257
96" OD Medium-Duty Snow Bucket (BOE Included)	11196-0022	795	\$3,589
101" OD Medium-Duty Snow Bucket (BOE Included)	11101-0022	820	\$3,769
<b>Heavy-Duty Snow Bucket</b>			
96" OD Heavy-Duty Snow Bucket (BOE Included)	11197-0022	999	\$4,351
101" OD Heavy-Duty Snow Bucket (BOE Included)	11102-0022	1020	\$4,443
108" OD Heavy-Duty Snow Bucket (BOE Included)	11108-0022	1078	\$4,695
<b>MOUNTING - ADDITIONAL COST MAY APPLY</b>		ORDER CODE	SHIP WEIGHT (LBS)
Contact Customer Service at (833) 723-1843			

OPTIONS - REVERSIBLE CUTTING EDGE KIT	OPTIONAL BOLT ON EDGE	SHIP WEIGHT (LBS)	LIST PRICE
<b>Includes BOE, grade 8 plow bolts, lock washers &amp; nuts Drilled for FFC bolt-on edge (Holes spaced 6" apart, center to center)</b>			
For Bucket 11184-0022 (9 holes, 9.75" spacing)	16183	203	\$715
For Bucket 11196-0022 (16 holes, 6" spacing)	FFC10084	232	\$728
For Bucket 11197-0022 (16 holes, 6" spacing)	FFC10084	232	\$728
For Bucket 11101-0022 (17 holes, 6" spacing)	118960	247	\$805
For Bucket 11102-0022 (17 holes, 6" spacing)	118960	247	\$805
For Bucket 11108-0022 (18 holes, 6" spacing)	10094	254	\$967

## SNOW PUSH

### 228 SERIES SNOW PUSH (4 FT X 4 FT)



- Moves large volumes of snow efficiently. Also ideal for waste water, manure, feed lot and flood cleanup
- Optional pull back kit draws back snow from buildings, fences and confined areas
- Optional bucket lip mount available for 12' and 14' models

Carrier Specifications	
Lift Capacity	Operating Weight
<11,000 lbs.	<32,000 lbs.

228 Series (4 ft x 4 ft) Snow Push Specifications					
Model	Path Width	Working Height	Depth	Overall Width	Weight (approx)
22812	142.5"	48.8"	71.8"	149.7"	2485
22814	166.5"	48.8"	71.8"	173.7"	2660
22816	190.5"	48.8"	71.8"	197.7"	2835
22820	238.5"	48.8"	71.8"	245.7"	3185

### 228 SERIES SNOW PUSH (4 FT X 4 FT) FOR TRACTOR LOADERS/BACKHOES, UTILITY TRACTORS AND WHEEL LOADERS



**INCLUDES: SNOW PUSH, RUBBER EDGE AND HEAVY DUTY SNOW SHOES. EXCLUDES MOUNTING CHARGES. TO ORDER: CHOOSE SNOW PUSH AND MOUNT**

SNOW PUSH	ORDER CODE	SHIP WEIGHT (LBS)	LIST PRICE
12 ft 228 Series 4x4 Snow Push, Bucket Lip Mount	22812-0057	2485	\$15,373
12 ft 228 Series 4x4 Snow Push, JRB 416 Mount	22812-0913	2485	\$15,125
12 ft 228 Series 4x4 Snow Push, Volvo QA	22812-0934	2485	\$15,125
14 ft 228 Series 4x4 Snow Push, Bucket Lip Mount	22814-0057	2660	\$15,376
14 ft 228 Series 4x4 Snow Push, JRB 416 Mount	22814-0913	2660	\$15,483
14 ft 228 Series 4x4 Snow Push, Volvo QA	22814-0934	2660	\$15,483
16 ft 228 Series 4x4 Snow Push, Bucket Lip Mount	22816-0057	2835	\$16,114
16 ft 228 Series 4x4 Snow Push, JRB 416 Mount	22816-0913	2835	\$16,200
16 ft 228 Series 4x4 Snow Push, Volvo QA	22816-0934	2835	\$16,200
20 ft 228 Series 4x4 Snow Push, Bucket Lip Mount	22820-0057	3185	\$17,242
20 ft 228 Series 4x4 Snow Push, JRB 416 Mount	22820-0913	3185	\$20,150
20 ft 228 Series 4x4 Snow Push, Volvo QA	22820-0934	3185	\$20,150

MOUNTING	ORDER CODE	SHIP WEIGHT (LBS)
Contact Customer Service at (833) 723-1843 for pricing and availability of alternative mounts.		

OPTIONS	ORDER CODE	SHIP WEIGHT (LBS)	
Chain & Binder Kit	28-9213	N/A	\$712

# SNOW REMOVAL

## SNOW PUSH

228 SERIES SNOW PUSH (4 FT X 4 FT) FOR TRACTOR LOADERS/BACKHOES, UTILITY TRACTORS AND WHEEL LOADERS CONT.

REPLACEMENT PARTS	ORDER CODE	SHIP WEIGHT (LBS)	LIST PRICE
<b>Rubber Edge Kits for Snow Push (Includes Hardware and Retaining Plates)</b>			
Rubber Edge Kit for 12' Snow Push	28-10842-12	170	\$2,116
Rubber Edge Kit for 14' Snow Push	28-10842-14	190	\$2,085
Rubber Edge Kit for 16' Snow Push	28-10842-16	210	\$2,696
Rubber Edge Kit for 20' Snow Push	28-10842-20	260	\$2,792
<b>Snow Shoe</b>			
Snow Shoe (1 shoe)	13-17627	130	\$1,405

## 232 SERIES SNOW PUSH - LOW PROFILE



- Moves large volumes of snow efficiently. Also ideal for waste water, manure, feed lot and flood cleanup
- Optional pull back kit draws back snow from buildings, fences and confined areas

Carrier Specifications	
Lift Capacity	Operating Weight
<9,500 lbs.	<11,500 lbs.

Specifications					
Model	Path Width	Working Height	Depth	Overall Width	Weight (approx)
23272-0022	71.5"	23.7"	38.1"	77.3"	525 lbs
23284-0022	83.5"	23.7"	38.1"	89.3"	570 lbs
23296-0022	95.5"	23.7"	38.1"	101.3"	610 lbs
23220-0022	119.5"	23.7"	38.1"	125.3"	705 lbs

## 232 SERIES SNOW PUSH - LOW PROFILE FOR SKID-STEER LOADERS



**INCLUDES: SNOW PUSH, RUBBER EDGE, STANDARD SNOW SHOES, RUBBER EDGE AND UNIVERSAL SSL MOUNTING. OPTIONAL HEAVY DUTY SNOW SHOES AVAILABLE TO ORDER: CHOOSE SNOW PUSH AND MOUNT**

SNOW PUSH	ORDER CODE	SHIP WEIGHT (LBS)	LIST PRICE
6' 232 Series Low Profile Snow Push	23272-0022	605	\$3,418
7' 232 Series Low Profile Snow Push	23284-0022	670	\$3,524
8' 232 Series Low Profile Snow Push	23296-0022	735	\$3,703
10' 232 Series Low Profile Snow Push	23220-0022	865	\$4,149

## SNOW PUSH

### 232 SERIES SNOW PUSH - LOW PROFILE CONT.

OPTIONS	ORDER CODE	SHIP WEIGHT (LBS)	
<b>Pull Back Kit Without Rubber Edge</b>			
<b>Factory Installed (ordered with Snow Push) Add weight to ordered Snow Push</b>			
6' Pull Back Kit w/out Rubber Edge	28-10751-72	155	\$1,012
7' Pull Back Kit w/out Rubber Edge	28-10751-84	175	\$1,337
8' Pull Back Kit w/out Rubber Edge	28-10751-96	200	\$1,536
10' Pull Back Kit w/out Rubber Edge	28-10751-120	250	\$1,212
<b>Field Installed (After Market Kit)</b>			
6' Pull Back Kit w/out Rubber Edge	28-10837-72	200	\$1,217
7' Pull Back Kit w/out Rubber Edge	28-10837-84	235	\$1,357
8' Pull Back Kit w/out Rubber Edge	28-10837-96	270	\$1,405
10' Pull Back Kit w/out Rubber Edge	28-10837-120	330	\$1,637
<b>Pull Back Kit With Rubber Edge</b>			
<b>Factory Installed (ordered with Snow Push) Add weight to ordered Snow Push</b>			
6' Pull Back Kit with Rubber Edge	28-10753-72	185	\$1,461
7' Pull Back Kit with Rubber Edge	28-10753-84	215	\$1,685
8' Pull Back Kit with Rubber Edge	28-10753-96	245	\$1,795
10' Pull Back Kit with Rubber Edge	28-10753-120	300	\$1,671
<b>Field Installed (After Market Kit)</b>			
6' Pull Back Kit with Rubber Edge	28-10838-72	235	\$2,056
7' Pull Back Kit with Rubber Edge	28-10838-84	275	\$1,617
8' Pull Back Kit with Rubber Edge	28-10838-96	315	\$1,757
10' Pull Back Kit with Rubber Edge	28-10838-120	380	\$2,212
<b>REPLACEMENT PARTS</b>			
<b>Rubber Edge Kits (Includes Hardware and Retaining Plates)</b>			
6' Rubber Edge Kit for Snow Push or Pullback Kit	28-10840-72	70	\$735
7' Rubber Edge Kit for Snow Push or Pullback Kit	28-10840-84	80	\$778
8' Rubber Edge Kit for Snow Push or Pullback Kit	28-10840-96	90	\$959
10' Rubber Edge Kit for Snow Push or Pullback Kit	28-10840-120	110	\$1,087
<b>Snow Shoes</b>			
Standard Duty Snow Shoe (1 shoe)	LAF3605-0000	50	\$507
Heavy Duty Snow Shoe (1 shoe)	13-18356	60	\$735

# SNOW REMOVAL

## SNOW PUSH

### 233 SERIES SNOW PUSH (3 FT X 3 FT)



- Moves large volumes of snow efficiently. Also ideal for waste water, manure, feed lot and flood cleanup
- Optional pull back kit draws back snow from buildings, fences and confined areas
- Optional bucket lip mount available for 10', 12' and 14' models

Carrier Specifications	
Lift Capacity	Operating Weight
<11,000 lbs.	<20,000 lbs.

233 Series (3ft x 3ft) Snow Push Specifications					
Model	Path Width	Working Height	Depth	Overall Width	Weight (approx)
23396	95.5"	41.3"	41.5"	101.5"	1100 lbs
23320	119.5"	41.3"	41.5"	125.5"	1230 lbs
23344	143.5"	41.3"	41.5"	149.5"	1375 lbs
23368	167.5"	41.3"	41.5"	173.5"	1505 lbs

### 233 SERIES SNOW PUSH (3 FT X 3 FT) FOR SKID-STEER LOADERS, TRACTOR LOADERS/BACKHOES, UTILITY TRACTORS AND WHEEL LOADERS



**i** INCLUDES: SNOW PUSH, RUBBER EDGE, STANDARD SNOW SHOES, RUBBER EDGE AND UNIVERSAL SSL MOUNTING. OPTIONAL HEAVY DUTY SNOW SHOES AVAILABLE TO ORDER: CHOOSE SNOW PUSH AND MOUNT

SNOW PUSH	ORDER CODE	SHIP WEIGHT (LBS)	LIST PRICE
8' 233 Series 3x3 Snow Push	23396-0022	1,220	\$5,811
10' 233 Series 3x3 Snow Push	23320-0022	1,390	\$6,134
12' 233 Series 3x3 Snow Push	23344-0022	1,575	\$6,519
14' 233 Series 3x3 Snow Push	23368-0022	1,745	\$11,300

MOUNTING	ORDER CODE	SHIP WEIGHT (LBS)
Universal SSL Mount	0022	N/A

Standardized mounting with the exception of ACS, CAT Fusion and Bobcat X-Change

Contact Customer Service at (833) 723-1843 for pricing and availability of alternative mounts.

OPTIONS	ORDER CODE	SHIP WEIGHT (LBS)	LIST PRICE
<b>Pull Back Kit Without Rubber Edge</b>			
<b>Factory Installed (ordered with Snow Push) Add weight to ordered Snow Push</b>			
8' Pull Back Kit w/out Rubber Edge	28-10751-96	200	\$1,536
10' Pull Back Kit w/out Rubber Edge	28-10751-120	250	\$1,212
12" Pull Back Kit w/out Rubber Edge	28-10751-144	290	\$1,169
14" Pull Back Kit w/out Rubber Edge	28-10751-168	335	\$3,204

233 SERIES CONTINUED NEXT PAGE

## SNOW PUSH

233 SERIES SNOW PUSH (3 FT X 3 FT) FOR SKID-STEER LOADERS, TRACTOR LOADERS/BACKHOES, UTILITY TRACTORS AND WHEEL LOADERS CONT.

OPTIONS	ORDER CODE	SHIP WEIGHT (LBS)	LIST PRICE
<b>Pull Back Kit Without Rubber Edge</b>			
<b>Field Installed (After Market Kit)</b>			
8' Pull Back Kit w/out Rubber Edge	28-10837-96	270	\$1,405
10' Pull Back Kit w/out Rubber Edge	28-10837-120	330	\$1,637
12' Pull Back Kit w/out Rubber Edge	28-10837-144	380	\$1,963
14' Pull Back Kit w/out Rubber Edge	28-10837-168	435	\$3,849
<b>Pull Back Kit With Rubber Edge</b>			
<b>Factory Installed (ordered with Snow Push) Add weight to ordered Snow Push</b>			
8' Pull Back Kit with Rubber Edge	28-10753-96	245	\$1,795
10' Pull Back Kit with Rubber Edge	28-10753-120	300	\$1,671
12' Pull Back Kit with Rubber Edge	28-10753-144	350	\$2,213
14' Pull Back Kit with Rubber Edge	28-10753-168	410	\$4,367
<b>Field Installed (After Market Kit)</b>			
8' Pull Back Kit with Rubber Edge	28-10838-96	314	\$1,757
10' Pull Back Kit with Rubber Edge	28-10838-120	382	\$2,212
12' Pull Back Kit with Rubber Edge	28-10838-144	441	\$2,185
14' Pull Back Kit with Rubber Edge	28-10838-168	508	\$5,146

REPLACEMENT PARTS	ORDER CODE	SHIP WEIGHT (LBS)	LIST PRICE
<b>Rubber Edge Kits (Includes Hardware and Retaining Plates)</b>			
<b>Rubber Edge Kits for Snow Push</b>			
Rubber Edge Kit for 8' Snow Push	28-10841-96	130	\$1,172
Rubber Edge Kit for 10' Snow Push	28-10841-120	150	\$1,453
Rubber Edge Kit for 12' Snow Push	28-10841-144	170	\$2,035
Rubber Edge Kit for 14' Snow Push	28-10841-168	190	\$2,585
<b>Rubber Edge Kits for Pullback Kit</b>			
Rubber Edge Kit for 8' Pullback Kit	28-10840-96	90	\$959
Rubber Edge Kit for 10' Pullback Kit	28-10840-120	110	\$1,087
Rubber Edge Kit for 12' Pullback Kit	28-10840-144	125	\$1,306
Rubber Edge Kit for 14' Pullback Kit	28-10840-168	135	\$1,359
<b>Snow Shoes</b>			
Standard Duty Snow Shoe (1 shoe)	LAF3605-0000	50	\$507
Heavy Duty Snow Shoe (1 shoe)	13-18356	60	\$735

# SNOW REMOVAL

## SNOW PUSH

### COMPACT TRACTOR SNOW PUSH



- Moves large volumes of snow efficiently. Also ideal for waste water, manure, feed lot and flood cleanup
- Optional pull back kit draws back snow from buildings, fences and confined areas

Carrier Specifications	
Lift Capacity	Operating Weight
<2,000 lbs.	<4,000 lbs.

Compact Tractor Snow Push Specifications					
Model	Path Width	Working Height	Depth	Overall Width	Weight (approx)
10707-60-0822	61.8"	30.8"	34"	62.3"	415 lbs
10707-72-0822	73.8"	30.8"	34"	74.3"	450 lbs
10707-84-0822	85.8"	30.8"	34"	86.3"	484 lbs
10707-96-0822	97.8"	30.8"	34"	98.3"	518 lbs

### COMPACT TRACTOR SNOW PUSH



SNOW PUSH	ORDER CODE	SHIP WEIGHT (LBS)	LIST PRICE
<b>Compact Tractor Snow Push includes Rubber Edge</b>			
5 ft Compact Tractor Snow Push	10707-60-0822	500	\$1,862
6 ft Compact Tractor Snow Push	10707-72-0822	530	\$1,880
7 ft Compact Tractor Snow Push	10707-84-0822	580	\$2,900
8 ft Compact Tractor Snow Push	10707-96-0822	625	\$3,100

REPLACEMENT PARTS	ORDER CODE	SHIP WEIGHT (LBS)	LIST PRICE
<b>Rubber Edge Kits (Includes Hardware and Retaining Plates)</b>			
Rubber Edge Kit for 5' Snow Push	28-10840-60	60	\$919
Rubber Edge Kit for 6' Snow Push	28-10840-72	70	\$735
Rubber Edge Kit for 7' Snow Push	28-10840-84	80	\$778
Rubber Edge Kit for 8' Snow Push	28-10840-96	90	\$959

## SNOW PUSH

### COMPACT TRACTOR TRIP EDGE SNOW PUSH



- Moves large volumes of snow efficiently. Also ideal for waste water, manure, feed lot and flood cleanup
- Optional pull back kit draws back snow from buildings, fences and confined areas

Carrier Specifications	
Lift Capacity	Operating Weight
<4,000 lbs.	<8,000 lbs.

Compact Tractor Trip Edge Models Snow Push Specifications					
Model	Path Width	Working Height	Depth	Overall Width	Weight (approx)
10709-78-0822	72.9"	39.8"	44.1"	80.4"	850 lbs
10709-96-0822	90.9"	39.8"	44.1"	98.4"	930 lbs
10709-08-0822	102.9"	39.8"	44.1"	110.4"	990 lbs
10709-20-0822	112.4"	39.8"	44.1"	119.9"	1030 lbs

### COMPACT TRACTOR TRIP EDGE SNOW PUSH



SNOW PUSH	ORDER CODE	SHIP WEIGHT (LBS)	LIST PRICE
<b>Compact Tractor Trip Edge Snow Push includes Steel Edge</b>			
6.5 ft Compact Tractor Trip Edge Snow Push	10709-78-0822	920	\$5,000
8 ft Compact Tractor Trip Edge Snow Push	10709-96-0822	970	\$5,500
9 ft Compact Tractor Trip Edge Snow Push	10709-08-0822	1020	\$6,598
10 ft Compact Tractor Trip Edge Snow Push	10709-20-0822	1140	\$6,848

OPTIONS	ORDER CODE	SHIP WEIGHT (LBS)	LIST PRICE
<b>Pull Back Kit Without Rubber Edge</b>			
<b>Factory Installed (ordered with Snow Push) Add weight to ordered Snow Push</b>			
6.5' Pull Back Kit w/out Rubber Edge	28-10468	180	\$1,574
8' Pull Back Kit w/out Rubber Edge	28-10469	200	\$1,681
9' Pull Back Kit w/out Rubber Edge	28-10470	215	\$1,914
10' Pull Back Kit w/out Rubber Edge	28-10471	230	\$1,692
<b>Field Install (After Market Kit)</b>			
6.5' Pull Back Kit w/out Rubber Edge for 10709-78 Snow Push	10740-FFC	230	\$1,695
8' Pull Back Kit w/out Rubber Edge for 10709-96 Snow Push	10730-FFC	255	\$1,906
9' Pull Back Kit w/out Rubber Edge for 10709-08 Snow Push	10731-FFC	275	\$2,138
10' Pull Back Kit w/out Rubber Edge for 10709-20 Snow Push	10732-FFC	295	\$1,916

COMPACT TRACTOR TRIP EDGE SNOW PUSH CONTINUED NEXT PAGE

# SNOW REMOVAL

## SNOW PUSH

### COMPACT TRACTOR TRIP EDGE SNOW PUSH CONT.

OPTIONS CONT.	ORDER CODE	SHIP WEIGHT (LBS)	
<b>Pull Back Kit With Rubber Edge</b>			
<b>Factory Installed (ordered with Snow Push) Add weight to ordered Snow Push</b>			
6.5' Pull Back Kit with Rubber Edge for 10709-78 Snow Push	28-10478	200	\$1,352
8' Pull Back Kit with Rubber Edge for 10709-96 Snow Push	28-10479	225	\$2,519
9' Pull Back Kit with Rubber Edge for 10709-08 Snow Push	28-10480	240	\$2,584
10' Pull Back Kit with Rubber Edge for 10709-20 Snow Push	28-10481	260	\$2,495
<b>Field Install (After Market Kit)</b>			
6.5' Pull Back Kit with Rubber Edge for 10709-78 Snow Push	28-10488	250	\$2,208
8' Pull Back Kit with Rubber Edge for 10709-96 Snow Push	28-10489	280	\$2,036
9' Pull Back Kit with Rubber Edge for 10709-08 Snow Push	28-10490	300	\$2,765
10' Pull Back Kit with Rubber Edge for 10709-20 Snow Push	28-10491	325	\$3,481

REPLACEMENT PARTS	ORDER CODE	SHIP WEIGHT (LBS)	
<b>Cutting Edge Kits (Includes Hardware)</b>			
<b>Steel Edge Kits for Snow Push</b>			
Steel Edge Kit for 6.5' Snow Push	11614	100	\$587
Steel Edge Kit for 8' Snow Push	11610	120	\$330
Steel Edge Kit for 9' Snow Push	11611	140	\$310
Steel Edge Kit for 10' Snow Push	28-10839	160	\$429
<b>Rubber Edge Kits for Pullback Kit</b>			
Rubber Edge Kit for 6.5' Pullback Kit	28-10840-84	90	\$778
Rubber Edge Kit for 8' Pullback Kit	28-10840-96	110	\$959
Rubber Edge Kit for 9' Pullback Kit	28-10840-108	125	\$807
Rubber Edge Kit for 10' Pullback Kit	28-10840-120	135	\$1,087

# STRIKEFORCE™



# STRIKEFORCE

## STRIKEFORCE BREAKERS



- Box style breaker - Reduced noise pollution & carrier protection
- Hybrid Gas/oil working principle - High efficiency & impact energy
- Internal Control Valve - Higher efficiency, performance & reliability
- 2 moving parts - Reduced maintenance higher ROI

### SPECIFICATIONS

Model	Tool Diameter	Suitable Carrier	Required Oil Flow	Operating Pressure	Blow Range - Power Mode	Blow Range - Speed Mode
SFB 150-2	1.57"	1100~3300 lbs	4~6 GPM	860~890 PSI	800~1200 BPM	800~1200 BPM
SFB 250-2	1.77"	1800~6600 lbs	4~8 GPM	1300~1740 PSI	550~1000 BPM	550~1000 BPM
SFB 350-2	2.24"	3300~11000 lbs	6~19 GPM	1300~1740 PSI	600~1500 BPM	600~1500 BPM
SFB 500-2	2.76"	8800~15500 lbs	8~16 GPM	1600~2400 PSI	380~1500 BPM	380~1500 BPM
SFB 750-2	2.95"	11000~19900 lbs	9~18 GPM	1740~2400 PSI	380~900 BPM	380~900 BPM
SFB 1000-2	3.15"	13300~22100 lbs	10~22 GPM	2030~2470 PSI	400~800 BPM	600~1100 BPM
SFB 1500-2	3.54"	15500~26500 lbs	11~22 GPM	2030~2470 PSI	350~700 BPM	490~1000 BPM

## STRIKEFORCE BREAKERS

BREAKERS	ORDER CODE	SHIP WEIGHT (LBS)	LIST PRICE
SFB 150-2 Breaker, Single Bracket		180	POR
SFB 150-2 Breaker, Combo Bracket		180	POR
SFB 250-2 Breaker, Single Bracket		310	POR
SFB 250-2 Breaker, Combo Bracket		310	POR
SFB 350-2 Breaker, Single Bracket		410	POR
SFB 350-2 Breaker, Combo Bracket		410	POR
SFB 500-2 Breaker, Single Bracket		720	POR
SFB 500-2 Breaker, Combo Bracket		720	POR
SFB 750-2 Breaker, Single Bracket		910	POR
SFB 750-2 Breaker, Combo Bracket		940	POR
SFB 1000-2 Breaker, Single Bracket		1140	POR
SFB 1000-2 Breaker, Combo Bracket		1140	POR
SFB 1500-2 Breaker, Single Bracket		1320	POR

## STRIKEFORCE PLATE COMPACTORS



- "Outboard" shock isolator location provides stability for optimal transmission of impulse for effective compaction
- Shock isolators are angled to reduce damaging shear stresses in the isolator and extend life while providing a performance advantage in delivering compaction forces to the soil
- Integral Flow Control block manages flow and pressure to provide effective and repeatable compaction as well as to protect the hydraulic motor
- Oil bath bearing design maximizes bearing life while minimizing maintenance needs

SPECIFICATIONS							
Model	Overall Width	Overall Length	Overall Height	Compaction Area	Carrier Weight - Minimum	Carrier Weight - Maximum	Impulse Force
TPC250	11.75"	30"	18.8"	353 in <sup>2</sup>	2700 lbs	10000 lbs	2500 lbs
TPC350	18.75"	26"	19.1"	488 in <sup>2</sup>	2700 lbs	14000 lbs	3400 lbs
TPC1000	23.5"	35"	22.9"	823 in <sup>2</sup>	13000 lbs	28000 lbs	6400 lbs
TPC2K	24"	38"	24.5"	912 in <sup>2</sup>	13000 lbs	40000 lbs	8000 lbs
TPC4K	25.5"	38.5"	29.5"	982 in <sup>2</sup>	13000 lbs	50000 lbs	11350 lbs
TPC10K	33"	49.5"	34.5"	1634 in <sup>2</sup>	37000 lbs	130000 lbs	22000 lbs

## STRIKEFORCE PLATE COMPACTORS

PLATE COMPACTORS	ORDER CODE	SHIP WEIGHT (LBS)	PRICE LIST
TPC250 Plate Compactor	245250-BLNK	305	\$6,192
TPC350 Plate Compactor	245350-BLNK	473	\$6,597
TPC1000 Plate Compactor	24501K-BLNK	891	\$7,544
TPC2K Plate Compactor	24502K-BLNK	1007	\$9,283
TPC4K Plate Compactor	24504K-BLNK	1553	\$13,717
TPC10K Plate Compactor	24510K-BLNK	2620	\$18,903

# STUMP GRINDER

## STUMP GRINDER



- Standard flow (SG26) & High Flow (SG30)
- Wheel Grinds stumps down to 12" below grade with 28 teeth
- Tooth bottom permits cutting from side-to-side and vertical directions
- 60° range of motion will cover 45" in a single sweep
- Grouser pad stabilization prevents plunge stalls
- Dial adjust swing speed

### Specifications

Model	Width	Height	Length	Below Ground Depth	Swing Arc	Wheel Dia.	GPM	Weight lbs.
SG26	58"	37"	73"	10"	60°	26"	16-23	720
SG30	58"	37"	73"	12"	60°	30"	29-44	795

## STUMP GRINDER FOR SKID-STEER LOADERS



**TO ORDER: CHOOSE STUMP GRINDER, CONTROL, CUTTER WHEEL AND HYDRAULIC KIT**

STUMP GRINDER ASSEMBLY	ORDER CODE	SHIP WEIGHT (LBS)	LIST PRICE
SG26 standard flow - requires 26" diameter wheel 16 to 23 GPM flow	100319	720	\$9,325
SG30 high flow - requires 30" diameter wheel 29 to 44 GPM flow	100320	795	\$10,357

HYDRAULIC CONTROL AND WIRE HARNESS OPTIONS (MUST CHOOSE ONE)	ORDER CODE	SHIP WEIGHT (LBS)	LIST PRICE
Control box w/ power lead	28-10754	5	\$383
Wire harness for CAT (14-pin "D" series)	07-8344	5	\$273
Wire harness for CAT pre-B (8-pin Deutsch)	07-10021	5	\$372
Wire harness for standard flow attachments on CAT B and C (8-pin Deutsch)	07-10122	5	\$346
Wire harness for John Deere-8 button (14-pin Deutsch)	LAF9361	5	\$362
Wire harness for John Deere EH control (14-pin Deutsch)	07-7626	5	\$711
Wire harness for John Deere (3-pin Deutsch)	07-7338	5	\$278
Wire harness for Komatsu (14-pin Deutsch)	07-10194	5	\$377
Wire harness for Komatsu (8-pin Deutsch)	07-10057	5	\$585
Wire Harness (multi function in cab controls) for CNH, JCB, Bobcat, Mustang, Kubota, Takeuchi, Volvo 14 Pin-8 Pin	LAF9360-0000	5	\$268
Wire harness for CNH (8-pin rectangular)	LAF9393	5	\$222

CUTTER WHEEL	ORDER CODE	SHIP WEIGHT (LBS)	LIST PRICE
26" square threaded single-bolt tooth	101234	140	\$1,548
26" bolt-on shark style tooth	101243	170	\$2,243
30" square threaded single-bolt tooth	100418	160	\$1,731
30" bolt-on shark style tooth	100416	215	\$2,058

STUMP GRINDER CONTINUED NEXT PAGE

## STUMP GRINDER

### STUMP GRINDER FOR SKID-STEER LOADERS CONT.

HYDRAULIC KITS	ORDER CODE	SHIP WEIGHT (LBS)	LIST PRICE
(2) 72"x.62 hoses .50" flat face couplers (standard flow) 14 to 28 GPM	100983	15	\$362
(2) 88"x.62 hoses .50" flat face couplers (standard flow) 14 to 28 GPM	100984	10	\$368
(2) 88"x.75 hose .50 flat face couplers (high flow) 29 to 44 GPM	117736	28	\$766
(2) 72"x.75 hoses .625" flat face couplers (high flow) 29 to 44 GPM	101754	24	\$698
(2) 88"x.75 hoses .625" flat face couplers (high flow) 29 to 44 GPM	101755	28	\$946
(2) 72"x.75 hoses .75" flat face couplers (high flow) 29 to 44 GPM	102073	24	\$841
(2) 88"x.75 hoses .75" flat face couplers (high flow) 29 to 44 GPM	102074	28	\$671

REPLACEMENT PARTS	ORDER CODE	SHIP WEIGHT (LBS)	LIST PRICE
(28) replacement square tooth kit assembly	102075	15	\$1,110
(32) replacement bolt-on shark style tooth	102076	45	\$1,538
Stump Grinder guard kit	123465	65	\$2,051

Add Surcharge to all products 8.85%

Add Surcharge to all products 8.85%

# SWEEPERS



# SWEEPERS

Sweepster by Paladin, provides high quality sweepers and replacement brushes that are durable enough to perform under the most challenging conditions. Sweepster is the industry leader in rotary brooms and offers a complete line of sweepers for every prime mover and application.



Sweepster Sweepers are capable of handling all types of material including fine dirt, gravel, mud, millings and other debris.

- The only waterless dust mitigation system (patented)
- Higher capacity buckets (22%) equal high performance and increased efficiency (available on selected models)
- Multiple Sweeper types:
  - ~ Angle Sweepers
  - ~ Collector Sweepers
  - ~ Collector Sweepers with waterless dust abatement (patented and exclusive to Paladin)
- Tool-less Quick Change Core and many other standard features

## HOW TO ORDER AN ATTACHMENT

Since many of our attachments are customized to your needs, when you place your order you will need to choose your attachment, the mounting, and any options you would like. As you look through the products, notice the red headings in the charts - they will alert you to the choices you need to make.

Choose your attachment

BRUSH HEAD AND BRUSH MATERIAL	ORDER CODE	SHIP WEIGHT (LBS)
<b>Front-Mount Hydraulic Drive Brush Head - All Polypropylene Brush GPM Range 8-15</b>		
S26 4 ft hydraulic brush head	S26P4SM14	340
S26 5 ft hydraulic brush head	S26P5SM14	370
S26 6 ft hydraulic brush head	S26P6SM14	400

Choose a mount

MOUNTING AND SWING ASSEMBLY (ONE REQUIRED)	ORDER CODE	SHIP WEIGHT (LBS)
<b>Contact Customer Service for Mounting Availability</b>		
mounting & swing with hydraulic pump and tank for out front mowers	CMSH	240
mounting & swing without hydraulic pump and tank for out front mowers	CMSMH	100

The blue information bar will tell you what is included in the LIST PRICE and what you need to choose to order a complete attachment. It may also include other helpful information.



**TO ORDER: CHOOSE BRUSH HEAD & BRUSH MATERIAL, MOUNTING AND HYDRAULIC CONTROL PACKAGE INCLUDES: BRUSH HEAD & BRUSH MATERIAL AND MOUNT FOR CAT II OR CAT III 3-PT HITCH.**

The warning box contains important information pertaining to the attachment and prime mover and/or other safety information.



**IMPORTANT: Mounting & swing assembly requires 12 to 16 gpm at 2000 psi to operate sweeper**



**IMPORTANT: Must Ship Via Flatbed Motor Freight, Call Customer Service for Estimate**

If you have any questions about placing your order, contact Customer Service at (833) 723-1843.

## SSL ANGLE SWEEPER-HYDRAULIC DRIVE (QCSS ANGLE)



- Drive slips out of core without removing hydraulic lines from wheel motor
- Brush core is reversible for even brush wear
- 32" diameter brush for longer life
- Angles manually or hydraulically 30° left/right
- Faceted hood design provides maximum strength at ends of the hood
- Choose poly or poly/wire brush
- Includes skid steer mounting

Specifications						
Model #	Width	Width @ 30°	Motors	Brush Diameter	Weight (approx.)	GPM Range
22059	60"	54"	single	32"	793	10-18
22060	60"	54"	single	32"	793	12-25
22061	60"	54"	dual	32"	829	18-36
22071	72"	64"	single	32"	852	10-18
22072	72"	64"	single	32"	852	12-25
22073	72"	64"	dual	32"	890	18-36
22083	84"	75"	single	32"	915	10-18
22084	84"	75"	single	32"	915	12-25
22085	84"	75"	dual	32"	953	18-36
22096	96"	85"	single	32"	982	12-25
22097	96"	85"	dual	32"	1,022	18-36

### HOW TO ORDER YOUR SWEEPER

**Step 1:**  
Choose Sweeper

**Step 2:**  
Choose Angle Control

**Step 3:**  
Choose Mount

example: 22260P + M + 0022 = 22260PM-0022

## SSL ANGLE SWEEPER-HYDRAULIC DRIVE (QCSS ANGLE)



BRUSH HEAD AND BRUSH MATERIAL	ORDER CODE	SHIP WEIGHT (LBS)	PRICE LIST
<b>BRUSH HEAD WITH SINGLE MOTOR - 10-18 GPM, 2000-3500 PSI</b>			
<b>Brush Head with Single 18" Cubic Inch Motor (SM18) - All Polypropylene Brush</b>			
QC 5 ft hydraulic drive brush head	22059P	793	\$7,910
QC 6 ft hydraulic drive brush head	22071P	852	\$8,425
QC 7 ft hydraulic drive brush head	22083P	915	\$8,966
<b>Brush Head with Single Motor - Polypropylene &amp; Wire Brush</b>			
QC 5 ft hydraulic drive brush head	22059M	793	\$7,910
QC 6 ft hydraulic drive brush head	22071M	852	\$8,425
QC 7 ft hydraulic drive brush head	22083M	915	\$8,966

BRUSH HEADS CONTINUED NEXT PAGE

# SWEEPERS

## SSL ANGLE SWEEPER-HYDRAULIC DRIVE (QCSS ANGLE) CONT.

BRUSH HEAD AND BRUSH MATERIAL	ORDER CODE	SHIP WEIGHT (LBS)	LIST PRICE
<b>BRUSH HEAD WITH SINGLE MOTOR - 12-25 GPM, 2000-3000 PSI</b>			
<b>Brush Head with Single Motor - All Polypropylene Brush</b>			
QC 5 ft hydraulic drive brush head	22060P	831	\$7,910
QC 6 ft hydraulic drive brush head	22072P	890	\$8,425
QC 7 ft hydraulic drive brush head	22084P	953	\$8,966
QC 8 ft hydraulic drive brush head	22096P	1020	\$9,534
<b>Brush Head with Single Motor - Polypropylene &amp; Wire Brush</b>			
QC 5 ft hydraulic drive brush head	22060M	831	\$7,910
QC 6 ft hydraulic drive brush head	22072M	890	\$8,425
QC 7 ft hydraulic drive brush head	22084M	953	\$8,966
QC 8 ft hydraulic drive brush head	22096M	1020	\$9,534
<b>BRUSH HEAD WITH DUAL MOTOR - 20-36 GPM, 2000-3500 PSI</b>			
<b>Brush Head with Dual Motor - All Polypropylene Brush GPM</b>			
QC 5 ft hydraulic drive brush head	22061P	831	\$7,910
QC 6 ft hydraulic drive brush head	22073P	890	\$8,425
QC 7 ft hydraulic drive brush head	22085P	953	\$8,966
QC 8 ft hydraulic drive brush head	22097P	1020	\$9,534
<b>Brush Head with Dual Motor - Polypropylene &amp; Wire Brush</b>			
QC 5 ft hydraulic drive brush head	22061M	831	\$7,910
QC 6 ft hydraulic drive brush head	22073M	890	\$8,425
QC 7 ft hydraulic drive brush head	22085M	953	\$8,966
QC 8 ft hydraulic drive brush head	22097M	1020	\$9,534
<b>ANGLE TYPE MANUAL OR HYDRAULIC (ONE REQUIRED)</b>			
<b>Contact Customer Service for Mounting Information on Specific Tractors</b>			
manual angle change	M	n/a	Included
hydraulic angle change with electric valve 12 volt	H	22	\$2,391
hydraulic angle change with electric valve 24 volt	H2	22	\$2,391
hydraulic angle change cylinder and 72" hoses	H3	10	\$445
hydraulic angle change cylinder and 144" hoses	H4	20	\$678
hydraulic angle change cylinder only - no hoses	H5	17	\$445
<b>MOUNTING (ONE REQUIRED)</b>			
<b>Contact Customer Service for Additional Mounting Availability</b>			
universal skid steer mounting	0022	n/a	Included

## SSL ANGLE SWEEPER-HYDRAULIC DRIVE (QCSS ANGLE) CONT.

HYDRAULIC CONTROL OPTIONS (ONE REQUIRED)	ORDER CODE	SHIP WEIGHT (LBS)	LIST PRICE
7-pin for Bobcat	07-9548	5	\$985
Control box w/ power lead	28-10754	5	\$383
Wire harness for CAT pre-B (8-pin Deutsch)	07-10021	5	\$372
Wire harness for standard flow attachments on CAT B and C (8-pin Deutsch)	07-10122	5	\$346
Wire harness for CAT (14-pin "D" series)	07-8344	1	\$273
Wire Harness (multi function in cab controls) for CNH, JCB, Bobcat, Mustang, Kubota, Takeuchi, Volvo 14 Pin-8 Pin	LAF9360-0000	5	\$268
Wire harness for CNH (8-pin rectangular)	LAF9393	5	\$222
Wire harness for John Deere (3-pin Deutsch)	07-7338	5	\$278
Wire harness for John Deere-8 button (14-pin Deutsch)	LAF9361	5	\$362
Wire harness for John Deere EH control (14-pin Deutsch)	07-7626	5	\$711
Wire harness for Komatsu (14-pin Deutsch)	07-10194	5	\$377
Wire harness for Komatsu (8-pin Deutsch)	07-10057	5	\$585
60" of extra cable for H or H2	07-7887	2	\$133

OPTIONS	ORDER CODE	SHIP WEIGHT (LBS)	LIST PRICE
sight indicator flag	11-5897	10	\$252
sight indicator ball	28-9965	10	\$529
<b>Sprinkler Kits (select system and tank to complete kit)</b>			
Kit 12V pump/filter/nozzles/no tank - Field Installed	28-9919*	25	\$1,356
Kit 12V pump/filter/nozzles/no tank - Factory Installed	28-10114	25	\$1,356
Kit 25 gal Tank w/shut-off	28-4319**	75	\$882
<b>180 Hood - Factory Installed</b>			
for QC-5	28-10311-5	50	\$580
for QC-6	28-10311-6	55	\$698
for QC-7	28-10311-7	60	\$823
for QC-8	28-10311-8	65	\$944
<b>180 Hood - Field Installed</b>			
for QC-5	28-10361-5	50	\$580
for QC-6	28-10361-6	55	\$698
for QC-7	28-10361-7	60	\$823
for QC-8	28-10361-8	65	\$944
<b>Drape Deflector Includes 180 Hood - Factory Installed</b>			
for QC-5	28-10312-5	65	\$1,084
for QC-6	28-10312-6	70	\$1,084
for QC-7	28-10312-7	75	\$1,197
for QC-8	28-10312-8	80	\$1,312
<b>Drape Deflector Includes 180 Hood - Field Installed</b>			
for QC-5	28-10362-5	65	\$1,084
for QC-6	28-10362-6	70	\$1,084
for QC-7	28-10362-7	75	\$1,197
for QC-8	28-10362-8	80	\$1,312

\*customer supplied water source or other suitable kit required

\*\*customer supplied mounting system required (do not mount directly to sweeper hood)

# SWEEPERS

## TRUCK AND LARGE WHEEL LOADER ANGLE SWEEPER - HYDRAULIC DRIVE (WLA)



- 10 ft & 12 ft wide models available
- 36" diameter brush
- Dual motor design for high torque
- Quick change brush without breaking hydraulic lines
- Third valve required to operate - fourth valve required to operate optional hydraulic angle change
- Parallel linkage allows sweeper to follow ground contours
- Angles manually or hydraulically 30° left/right
- Choose poly or poly/wire brush

Specifications						
Model #	Width	Motors	Brush Diameter	Weight (approx.)	GPM Range	PSI Range
21319	120"	dual	36"	1943 lbs	12-30	3000-4500
21320	120"	dual	36"	1943 lbs	18-45	2300-4000
21321	120"	dual	36"	1943 lbs	24-60	2000-3500
21344	144"	dual	36"	2332 lbs	18-45	2300-4000
21345	144"	dual	36"	2332 lbs	24-60	2000-3500

### HOW TO ORDER YOUR SWEEPER



example: 21319P + M + LAF1661-0913 = 21319PM LAF1661-0913

## TRUCK AND LARGE ARTICULATED WHEEL LOADER ANGLE SWEEPER - HYDRAULIC DRIVE (WLA)



BUSH HEAD AND BRUSH MATERIAL	ORDER CODE	SHIP WEIGHT (LBS)	LIST PRICE
<b>Hydraulic Drive Brush Head - All Polypropylene Brush GPM Range 12-30, PSI Range 3000-4500</b>			
WLA 10 ft hydraulic drive brush head	21319P	1943	\$25,491
WLA 12 ft hydraulic drive brush head	21343P	2332	\$27,651
<b>Hydraulic Drive Brush Head - Polypropylene and Wire Brush</b>			
WLA 10 ft hydraulic drive brush head	21319M	1943	\$25,491
WLA 12 ft hydraulic drive brush head	21343M	2332	\$27,651
<b>Hydraulic Drive Brush Head - All Polypropylene Brush GPM Range 18-45, PSI Range 2300-4000</b>			
WLA 10 ft hydraulic drive brush head	21320P	1943	\$25,491
WLA 12 ft hydraulic drive brush head	21344P	2332	\$27,651
<b>Hydraulic Drive Brush Head - Polypropylene and Wire Brush</b>			
WLA 10 ft hydraulic drive brush head	21320M	1943	\$25,491
WLA 12 ft hydraulic drive brush head	21344M	2332	\$27,651

## TRUCK AND LARGE ARTICULATED WHEEL LOADER ANGLE SWEEPER - HYDRAULIC DRIVE (WLA) CONT.

BRUSH HEAD AND BRUSH MATERIAL CONT.	ORDER CODE	SHIP WEIGHT (LBS)	LIST PRICE
<b>Hydraulic Drive Brush Head - All Polypropylene Brush GPM Range 24-60, PSI Range 2000-3500</b>			
WLA 10 ft hydraulic drive brush head	21321P	1943	\$25,491
WLA 12 ft hydraulic drive brush head	21345P	2332	\$27,651
<b>Hydraulic Drive Brush Head - Polypropylene and Wire Brush</b>			
WLA 10 ft hydraulic drive brush head	21321M	1943	\$25,491
WLA 12 ft hydraulic drive brush head	21345M	2332	\$27,651
ANGLE TYPE MANUAL OR HYDRAULIC (ONE REQUIRED)	ORDER CODE	SHIP WEIGHT (LBS)	LIST PRICE
manual angle change	M	15	Included
hydraulic angle change with electric valve 12 volt	H	40	\$2,391
hydraulic angle change with electric valve 24 volt	H2	40	\$2,391
hydraulic angle change cylinder and 72" hoses	H3	10	\$445
hydraulic angle change cylinder and 144" hoses	H4	30	\$678
hydraulic angle change cylinder only - no hoses	H5	17	\$445
5 ft of extra cable (Optional - not required)	07-7155	2	\$311
MOUNTING (ONE REQUIRED)	ORDER CODE	SHIP WEIGHT (LBS)	LIST PRICE
<b>Contact Customer Service for Pricing &amp; Mount</b>			
Standardized mounting with the exception of ACS, Balderson, CAT Fusion, Bobcat X-Change, JRB 420, and Volvo L150	LAF1661-XXXX	n/a	\$1,592
OPTIONS	ORDER CODE	SHIP WEIGHT (LBS)	LIST PRICE
case drain kit for loaders with more than 750 PSI back pressure at 250 RPM	28-10040S	60	\$344
<b>Sprinkler Systems - Field Installed</b>			
sprinkler system tank 85 gallon with mounting and shut-off	28-4318	125	\$3,587
10ft & 12ft sprinkler system pump, filter, nozzles, 12 volt	28-9928	30	\$2,345
10ft & 12ft sprinkler system pump, filter, nozzles, 24 volt	28-10092	30	\$2,344
<b>180 Hood - Factory Installed</b>			
for WLA-10	28-10104-10	65	\$1,539
for WLA-12	28-10104-12	70	\$1,657
<b>180 Hood - Field Installed</b>			
for WLA-10	28-9932-10	65	\$1,508
for WLA-12	28-9932-12	70	\$1,625
<b>Drape Deflector Includes 180 Hood - Factory Installed</b>			
for WLA-10	28-10093-10	80	\$2,149
for WLA-12	28-10093-12	85	\$2,267
<b>Drape Deflector Includes 180 Hood - Field Installed</b>			
for WLA-10	28-9927-10	80	\$2,171
for WLA-12	28-9927-12	85	\$1,842

# SWEEPERS

## TRUCK AND WHEEL LOADER ANGLE SWEEPER - HYDRAULIC DRIVE (LA)

SWEEPERS



- 32" bristles extend brush life
- Drive slips out of core without removing hydraulic lines from wheel motor
- Brush core is reversible for even brush wear
- Powered by hydraulic motors mounted inside brush frame
- Third valve required to operate - fourth valve required to operate optional hydraulic angle change
- Parallel linkage with casters allows sweeper to follow ground contours
- Angles manually or hydraulically 30° left/right
- Choose poly or poly/wire brush
- Casters, standard

### Specifications

Model #	Width	Motors	Brush Diameter	Weight (approx.)	GPM Range	PSI Range
22197	96"	dual	32"	1288 lbs	20-36	2000-3500
22109	108"	dual	32"	1,338 lbs	20-36	2000-3500

### HOW TO ORDER YOUR SWEEPER

**Step 1:**  
Choose Sweeper

**Step 2:**  
Choose Angle Control

**Step 3:**  
Choose Mount

example: 22197M + M + LAF1661-0913 = 22197MM  
LAF1661-0913

## TRUCK AND WHEEL LOADER ANGLE SWEEPER - HYDRAULIC DRIVE (LA)



### BRUSH HEAD AND BRUSH MATERIAL

	ORDER CODE	SHIP WEIGHT (LBS)	LIST PRICE
<b>Hydraulic Drive Brush Head - All Polypropylene Brush</b>			
QC 8 ft hydraulic drive brush head	22197P	1612	\$17,301
QC 9 ft hydraulic drive brush head	22109P	1682	\$18,346
<b>Hydraulic Drive Brush Head - Polypropylene and Wire Brush</b>			
QC 8 ft hydraulic drive brush head	22197M	1612	\$17,301
QC 9 ft hydraulic drive brush head	22109M	1682	\$18,346

## TRUCK AND WHEEL LOADER ANGLE SWEEPER - HYDRAULIC DRIVE (LA)

ANGLE TYPE MANUAL OR HYDRAULIC (ONE REQUIRED)	ORDER CODE	SHIP WEIGHT (LBS)	LIST PRICE
manual angle change	M	15	Included
hydraulic angle change with electric valve 12 volt	H	40	\$2,391
hydraulic angle change with electric valve 24 volt	H2	40	\$2,391
hydraulic angle change cylinder and 72" hoses	H3	10	\$445
hydraulic angle change cylinder and 144" hoses	H4	30	\$678
hydraulic angle change cylinder only - no hoses	H5	17	\$445
5 ft of extra cable (Optional - not required)	07-7155	2	\$311

MOUNTING (ONE REQUIRED)	ORDER CODE	SHIP WEIGHT (LBS)	LIST PRICE
<b>Contact Customer Service for Pricing &amp; Mount</b>			
Standardized mounting with the exception of ACS, Balderson, CAT Fusion, Bobcat X-Change, JRB 420, and Volvo L150	LAF1661-XXXX	n/a	\$1,592

OPTIONS	ORDER CODE	SHIP WEIGHT (LBS)	LIST PRICE
storage stands	28-10397	60	\$447
sight indicator flag	11-5897	10	\$252
sight indicator ball	28-9965	10	\$529
<b>Caster Options</b>			
swing etc with heavy-duty tapered roller bearing casters	TRC	n/a	\$1,315
swing etc with heavy-duty solid caster wheels	SC	30	\$2,549
<b>Sprinkler Kits (select one system and one tank to complete a kit)</b>			
sprinkler system fits all nozzles and mounts to hood 12 volt factory installed	28-10114	24	\$1,356
sprinkler system fits all nozzles and mounts to hood 24 volt factory installed	28-10115	25	\$1,516
sprinkler system tank 25 gallon with mounting and shut-off	28-9524	75	\$1,441
sprinkler system tank 85 gallon with mounting and shut-off	28-4318	125	\$3,587
<b>Independent Hydraulic System Pump Drive</b>			
from rear PTO tank mount to 3-Point 20 GPM with pressure relief	11-7691	150	\$5,168
quick coupler kit for 3-Point hydraulic system	28-10014	24	\$169
<b>180 Hood - Factory Installed</b>			
for QC-8	28-10311-8	65	\$944
for QC-9	28-10311-9	70	\$952
<b>180 Hood - Field Installed</b>			
for QC-8	28-10361-8	65	\$944
for QC-9	28-10361-9	70	\$952
<b>Drape Deflector Includes 180 Hood - Factory Installed</b>			
for QC-8	28-10312-8	80	\$1,312
for QC-9	28-10312-9	85	\$1,417
<b>Drape Deflector Includes 180 Hood - Field Installed</b>			
for QC-8	28-10362-8	80	\$1,312
for QC-9	28-10362-9	85	\$1,417

# SWEEPERS

## COMMERCIAL TURF MOWER ANGLE SWEEPER - HYDRAULIC DRIVE (CTH)



- Angles manually 30° left or right; hydraulic angle kit also available
- Front PTO required
- Brush widths of 4', 5' and 6' available
- Uses mower lift
- Requires 15 to 30 HP

Specifications								
Model	14		18		Overall Width	Angle Type	Brush Diameter	Weight (Approx)
	GPM Range	PSI Range	GPM Range	PSI Range				
S26-4	8-15	1200-3500	10-18	1200-3500	48"	Manual	26"	340 lbs
S26-5	8-15	1200-3500	10/18	1200-3500	60"	Manual	26"	370 lbs
S26-6	8-15	1200-3500	10-18	1200-3500	72"	Manual	26"	500 lbs



**IMPORTANT:** Mounting & swing assembly requires 12 to 16 gpm at 2000 psi to operate sweeper

## COMMERCIAL TURF MOWER ANGLE SWEEPER - HYDRAULIC DRIVE (CTH)



**TO ORDER: CHOOSE BRUSH HEAD & BRUSH MATERIAL AND MOUNTING & SWING ASSEMBLY**



BRUSH HEAD AND BRUSH MATERIAL	ORDER CODE	SHIP WEIGHT (LBS)	LIST PRICE
<b>Front-Mount Hydraulic Drive Brush Head - All Polypropylene Brush GPM Range 8-15</b>			
S26 4 ft hydraulic brush head	S26P4SM14	340	\$3,721
S26 5 ft hydraulic brush head	S26P5SM14	370	\$4,198
S26 6 ft hydraulic brush head	S26P6SM14	400	\$4,198
<b>Front-Mount Hydraulic Drive Brush Head - Polypropylene &amp; Wire Brush</b>			
S26 4 ft hydraulic brush head	S26M4SM14	340	\$3,721
S26 5 ft hydraulic brush head	S26M5SM14	370	\$4,198
S26 6 ft hydraulic brush head	S26M6SM14	400	\$4,198
<b>Front-Mount Hydraulic Drive Brush Head - All Polypropylene Brush</b>			
S26 4 ft hydraulic brush head	S26P4SM18	340	\$3,721
S26 5 ft hydraulic brush head	S26P5SM18	370	\$4,198
S26 6 ft hydraulic brush head	S26P6SM18	400	\$4,198
<b>Front-Mount Hydraulic Drive Brush Head - Polypropylene &amp; Wire Brush</b>			
S26 4 ft hydraulic brush head	S26M4SM18	340	\$3,721
S26 5 ft hydraulic brush head	S26M5SM18	370	\$4,198
S26 6 ft hydraulic brush head	S26M6SM18	400	\$4,198

## COMMERCIAL TURF MOWER ANGLE SWEEPER - HYDRAULIC DRIVE (CTH) CONT.

MOUNTING AND SWING ASSEMBLY (ONE REQUIRED)	ORDER CODE	SHIP WEIGHT (LBS)	LIST PRICE
<b>Contact Customer Service for Mounting Availability</b>			
mounting & swing with hydraulic pump and tank for out front mowers	CMSH	240	POR
mounting & swing without hydraulic pump and tank for out front mowers	CMSMH	100	POR
OPTIONS	ORDER CODE	SHIP WEIGHT (LBS)	LIST PRICE
hydraulic angle change cylinder and 72" hoses	11-4191	6	\$827
hydraulic angle with electric valve and control box	11-5310	15	\$3,443
<b>Side Mount Caster Wheels</b>			
side mount caster wheels S26	28-10498	45	\$1,589
<b>Dirt Deflector</b>			
dirt deflector S26-4	28-10162-4	25	\$845
dirt deflector S26-5	28-10162-5	30	\$1,008
dirt deflector S26-6	28-10162-6	35	\$1,019

Add Surcharge to all products 8.85%

# SWEEPERS

## COMMERCIAL TURF MOWER ANGLE SWEEPER - MECHANICAL DRIVE (CTM)



- Angles manually 30° left or right; hydraulic angle kit also available
- Chain drive
- Front PTO required
- Uses mower lift
- Requires 15 to 30 HP

### Specifications

Model	Width	Angle (Left or Right)	Angle Type	Brush Diameter	Weight (Approx)
M24-4	48"	30°	manual	24"	223 lbs
M24-5	60"	30°	manual	24"	248 lbs
M24-6	72"	30°	manual	24"	273 lbs

## COMMERCIAL TURF MOWER ANGLE SWEEPER - MECHANICAL DRIVE (CTM)



**TO ORDER: CHOOSE BRUSH HEAD & BRUSH MATERIAL AND MOUNTING & SWING ASSEMBLY**

BRUSH HEAD AND BRUSH MATERIAL	ORDER CODE	SHIP WEIGHT (LBS)	LIST PRICE
<b>Mechanical Brush Head - All Polypropylene Brush</b>			
M24 4 ft mechanical brush head	M24P4A	223	\$2,575
M24 5 ft mechanical brush head	M24P5A	248	\$2,859
M24 6 ft mechanical brush head	M24P6A	273	\$3,275
<b>Mechanical Brush Head - Polypropylene &amp; Wire Brush</b>			
M24 4 ft mechanical brush head	M24C4A	223	\$2,622
M24 5 ft mechanical brush head	M24C5A	248	\$2,859
M24 6 ft mechanical brush head	M24C6A	273	\$3,275
MOUNTING AND SWING ASSEMBLY (ONE REQUIRED)	ORDER CODE	SHIP WEIGHT (LBS)	
<b>Contact Customer Service for Mounting Availability</b>			
manual angle mounting & swing for out-front mowers	CMSM	100	POR
manual angle mounting & swing for walk behind mowers	WBMSM	100	POR
OPTIONS	ORDER CODE	SHIP WEIGHT (LBS)	
hydraulic angle change cylinder and 72" hoses	11-4191	6	\$827
storage stands	13-0800	25	\$873
dirt deflector M24-4, M24-5	11-4414	25	\$952
dirt deflector 4 ft	28-10873-4	30	\$1,184
dirt deflector 5 ft	28-10873-5	40	\$1,435
side mount caster wheels	28-9543	35	\$906
frame mount caster wheels not available on all mountings	11-5818	35	\$909

## COMPACT TRACTOR LOADER ANGLE SWEEPER - HYDRAULIC DRIVE (MRHL)



- Angles manually or hydraulically 30° left or right
- Brush drive slips easily out of the core without removing hydraulic lines
- Hydraulic motor driven from loader's hydraulic system
- For vehicles without adequate hydraulic systems, independent hydraulic system available

### Specifications - S26 Sweeper

Model #	Width	Angle Type	Brush Diameter	Weight (approx.)	GPM Range	PSI Range
22248	48"	hydraulic/manual	26"	455 lbs	8-15	3000 max
22249	48"	hydraulic/manual	26"	460 lbs	10-18	3000 max
22260	60"	hydraulic/manual	26"	490 lbs	8-15	3000 max
22261	60"	hydraulic/manual	26"	500 lbs	10-18	3000 max
22272	72"	hydraulic/manual	26"	525 lbs	8-15	3000 max
22273	72"	hydraulic/manual	26"	535 lbs	10-18	3000 max

### Specifications - S30 Sweeper

Model #	Width	Angle Type	Brush Diameter	Weight (approx.)	GPM Range	PSI Range
22560	60"	hydraulic/manual	30"	520 lbs	8-15	3000 max
22561	60"	hydraulic/manual	30"	525 lbs	10-18	3000 max
22572	72"	hydraulic/manual	30"	555 lbs	8-15	3000 max
22573	72"	hydraulic/manual	30"	565 lbs	10-18	3000 max
22585	84"	hydraulic/manual	30"	595 lbs	10-18	3000 max

## COMPACT TRACTOR LOADER ANGLE SWEEPER - HYDRAULIC DRIVE (MRHL)



### HOW TO ORDER YOUR SWEEPER

**Step 1:**  
Choose Sweeper

**Step 2:**  
Choose Angle Control

**Step 3:**  
Choose Mount

example: 22260P + M + 0022 = 22260PM-0022

BRUSH HEAD AND BRUSH MATERIAL	ORDER CODE	SHIP WEIGHT (LBS)	LIST PRICE
<b>26" DIAMETER BRUSH HEAD - 8-15 GPM</b>			
<b>26" Diameter Brush Heads - All Polypropylene Brush</b>			
S26 4 ft hydraulic brush head	22248P	380	\$6,239
S26 5 ft hydraulic brush head	22260P	440	\$6,516
S26 6 ft hydraulic brush head	22272P	500	\$6,936
<b>26" Diameter Brush Heads - Polypropylene &amp; Wire Brush</b>			
S26 4 ft hydraulic brush head	22248M	380	\$6,239
S26 5 ft hydraulic brush head	22260M	440	\$6,516

BRUSH HEAD AND BRUSH MATERIAL CONTINUED NEXT PAGE

# SWEEPERS

## COMPACT TRACTOR LOADER ANGLE SWEEPER - HYDRAULIC DRIVE (MRHL) CONT.

BRUSH HEAD AND BRUSH MATERIAL	ORDER CODE	SHIP WEIGHT (LBS)	LIST PRICE
<b>26" DIAMETER BRUSH HEAD - 10-18 GPM</b>			
S26 6 ft hydraulic brush head	22272M	500	\$6,936
<b>26" Diameter Brush Heads - All Polypropylene Brush GPM Range 10-18</b>			
S26 4 ft hydraulic brush head	22249P	380	\$6,239
S26 5 ft hydraulic brush head	22261P	440	\$6,516
S26 6 ft hydraulic brush head	22273P	500	\$6,936
<b>26" Diameter Brush Heads - Polypropylene &amp; Wire Brush</b>			
S26 4 ft hydraulic brush head	22249M	380	\$6,239
S26 5 ft hydraulic brush head	22261M	440	\$6,516
S26 6 ft hydraulic brush head	22273M	500	\$6,936
<b>30" DIAMETER BRUSH HEAD - 8-15 GPM</b>			
<b>30" Diameter Brush Heads - All Polypropylene Brush</b>			
S30 5 ft hydraulic brush head	22560P	540	\$6,516
S30 6 ft hydraulic brush head	22572P	600	\$6,936
<b>30" Diameter Brush Heads - Polypropylene &amp; Wire Brush</b>			
S30 5 ft hydraulic brush head	22560M	540	\$6,516
S30 6 ft hydraulic brush head	22572M	600	\$6,936
<b>30" DIAMETER BRUSH HEAD - 10-18 GPM</b>			
<b>30" Diameter Brush Heads - All Polypropylene Brush GPM Range 10-18</b>			
S30 5 ft hydraulic brush head	22561P	540	\$7,427
S30 6 ft hydraulic brush head	22573P	600	\$7,847
S30 7 ft hydraulic brush head	22585P	660	\$8,788
<b>30" Diameter Brush Heads - Polypropylene &amp; Wire Brush</b>			
S30 5 ft hydraulic brush head	22561M	540	\$7,427
S30 6 ft hydraulic brush head	22573M	600	\$7,847
S30 7 ft hydraulic brush head	22585M	660	\$8,788
<b>ANGLE TYPE MANUAL OR HYDRAULIC (ONE REQUIRED)</b>			
manual angle change	M	n/a	Included
hydraulic angle change with electric valve - 12 volt	H	22	\$2,391
hydraulic angle change with electric valve - 24 volt	H2	22	\$2,391
hydraulic angle change cylinder and 72" hoses	H3	10	\$445
hydraulic angle change cylinder and 144" hoses	H4	20	\$678
hydraulic angle change cylinder only - no hoses	H5	17	\$445
<b>MOUNTING (ONE REQUIRED)</b>			
<b>Contact Customer Service for Additional Mounting Availability</b>			
universal skid steer mounting for skid steers under 1300 lb lift capacity	0022	n/a	Included
Standardized mounting with the exception of ACS, CAT Fusion and Bobcat X-Change			

## COMPACT TRACTOR LOADER ANGLE SWEEPER - HYDRAULIC DRIVE (MRHL) CONT.

HYDRAULIC CONTROL OPTIONS (ONE REQUIRED)	ORDER CODE	SHIP WEIGHT (LBS)	LIST PRICE
Control box w/ power lead	28-10754	5	\$383
Wire harness for CAT pre-B (8-pin Deutsch)	07-10021	5	\$372
Wire harness for standard flow attachments on CAT B and C (8-pin Deutsch)	07-10122	5	\$346
Wire harness for CAT (14-pin "D" series)	07-8344	1	\$273
Wire Harness (multi function in cab controls) for CNH, JCB, Bobcat, Mustang, Kubota, Takeuchi, Volvo 14 Pin-8 Pin	LAF9360-0000	5	\$268
Wire harness for CNH (8-pin rectangular)	LAF9393	5	\$222
Wire harness for John Deere (3-pin Deutsch)	07-7338	5	\$278
Wire harness for John Deere-8 button (14-pin Deutsch)	LAF9361	5	POR
Wire harness for John Deere EH control (14-pin Deutsch)	07-7626	5	\$711
Wire harness for Komatsu (14-pin Deutsch)	07-10194	5	\$377
Wire harness for Komatsu (8-pin Deutsch)	07-10057	5	\$585
60" of extra cable for H or H2	07-7887	2	\$133

OPTIONS	ORDER CODE	SHIP WEIGHT (LBS)	LIST PRICE
conversion kit manual to hydraulic with control box	11-5433	15	\$3,112
conversion kit manual to hydraulic without control box	11-4191	6	\$827
3-point mounted hydraulic system with tank, PTO driven pump & pressure relief	11-7692	144	\$5,319
quick coupler kit for 3-point hydraulic system	28-10014	24	\$169
<b>Dirt Deflector</b>			
dirt deflector S26/S30-4	28-10162-4	25	\$845
dirt deflector S26/S30-5	28-10162-5	30	\$1,008
dirt deflector S26/S30-6	28-10162-6	35	\$1,019
dirt deflector S30-7	28-10162-7	40	\$500
<b>Side Mount Caster Wheels</b>			
side mount caster wheels S26	28-10498	45	\$1,589
side mount caster wheels S30	28-10499	55	\$2,701

Add Surcharge to all products 8.85%

# SWEEPERS

## COMPACT TRACTOR ANGLE SWEEPER - HYDRAULIC DRIVE (MRH)

SWEEPERS



- Angles manually 30° left or right; hydraulic angle kit also available
- Mid or rear PTO required
- Brush widths of 4', 5' and 6' available
- Requires 15 to 25 HP

Specifications								
Model	14		18		Overall Width	Angle Type	Brush Diameter	Weight (Approx)
	GPM Range	PSI Range	GPM Range	PSI Range				
S26-4	8-15	1200-3500	10-18	1200-3500	48"	Manual	26"	380 lbs
S26-5	8-15	1200-3500	10-18	1200-3500	60"	Manual	26"	440 lbs
S26-6	8-15	1200-3500	10-18	1200-3500	72"	Manual	26"	500 lbs
S30-5	8-15	1200-3500	10-18	1200-3500	60"	Manual	30"	490 lbs
S30-6	8-15	1200-3500	10-18	1200-3500	72"	Manual	30"	550 lbs
S30-7	8-15	1200-3500	10-18	1200-3500	84"	Manual	30"	610 lbs

## COMPACT TRACTOR ANGLE SWEEPER- HYDRAULIC DRIVE (MRH)



**TO ORDER: CHOOSE BRUSH HEAD & BRUSH MATERIAL, MOUNTING & SWING ASSEMBLY, HYDRAULIC CONTROL OPTION AND MOUNTING**

BRUSH HEAD AND BRUSH MATERIAL	ORDER CODE	SHIP WEIGHT (LBS)	LIST PRICE
<b>26" DIAMETER BRUSH HEAD</b>			
<b>26" Diameter Brush Heads - All Polypropylene Brush GPM Range 8-15</b>			
S26 4 ft hydraulic brush head	S26P4SM14	340	\$3,721
S26 5 ft hydraulic brush head	S26P5SM14	370	\$4,198
S26 6 ft hydraulic brush head	S26P6SM14	400	\$4,198
<b>26" Diameter Brush Heads - Polypropylene &amp; Wire Brush</b>			
S26 4 ft hydraulic brush head	S26M4SM14	340	\$3,721
S26 5 ft hydraulic brush head	S26M5SM14	370	\$4,198
S26 6 ft hydraulic brush head	S26M6SM14	400	\$4,198
<b>26" Diameter Brush Heads - All Polypropylene Brush GPM Range 10-18</b>			
S26 4 ft hydraulic brush head	S26P4SM18	340	\$3,721
S26 5 ft hydraulic brush head	S26P5SM18	370	\$4,198
S26 6 ft hydraulic brush head	S26P6SM18	400	\$4,198
<b>26" Diameter Brush Heads - Polypropylene &amp; Wire Brush</b>			
S26 4 ft hydraulic brush head	S26M4SM18	340	\$3,721
S26 5 ft hydraulic brush head	S26M5SM18	370	\$4,198
S26 6 ft hydraulic brush head	S26M6SM18	400	\$4,198

BRUSH HEAD AND BRUSH MATERIAL CONTINUED NEXT PAGE

## COMPACT TRACTOR ANGLE SWEEPER-HYDRAULIC DRIVE (MRH)

BRUSH HEAD AND BRUSH MATERIAL CONT.	ORDER CODE	SHIP WEIGHT (LBS)	LIST PRICE
<b>30" DIAMETER BRUSH HEAD</b>			
<b>30" Diameter Brush Heads - All Polypropylene Brush GPM Range 8-15</b>			
S30 5 ft hydraulic brush head	S30P5SM14	420	\$4,914
S30 6 ft hydraulic brush head	S30P6SM14	450	\$5,391
S30 7 ft hydraulic brush head	S30P7SM14	480	\$5,990
<b>30" Diameter Brush Heads - Polypropylene &amp; Wire Brush</b>			
S30 5 ft hydraulic brush head	S30M5SM14	420	\$4,914
S30 6 ft hydraulic brush head	S30M6SM14	450	\$5,391
S30 7 ft hydraulic brush head	S30M7SM14	480	\$5,990
<b>30" Diameter Brush Heads - All Polypropylene Brush GPM Range 10-18</b>			
S30 5 ft hydraulic brush head	S30P5SM18	420	\$4,914
S30 6 ft hydraulic brush head	S30P6SM18	450	\$5,391
S30 7 ft hydraulic brush head	S30P7SM18	480	\$5,990
<b>30" Diameter Brush Heads - Polypropylene &amp; Wire Brush</b>			
S30 5 ft hydraulic brush head	S30M5SM18	420	\$4,914
S30 6 ft hydraulic brush head	S30M6SM18	450	\$5,391
S30 7 ft hydraulic brush head	S30M7SM18	480	\$5,990

MOUNTING AND SWING ASSEMBLY (ONE REQUIRED)	ORDER CODE	SHIP WEIGHT (LBS)	LIST PRICE
<b>Contact Customer Service for Mounting Availability</b>			
rear mounted hydraulic pump & tank for compact utility tractors	THMSMR	240	POR
mid mounted hydraulic pump & tank for compact utility tractors	THMSMM	240	POR

OPTIONS	ORDER CODE	SHIP WEIGHT (LBS)	LIST PRICE
hydraulic angle no valve (for manual angle sweepers only)	11-4191	6	\$827
hydraulic angle with electric valve and box	11-5310	15	\$3,443
3-point mounted hydraulic system with tank, PTO driven pump & pressure relief	11-7692	144	\$5,319
quick coupler kit for 3-point hydraulic system	28-10014	24	\$169
<b>Dirt Deflector</b>			
dirt deflector S26/S30-4	28-10162-4	25	\$845
dirt deflector S26/S30-5	28-10162-5	30	\$1,008
dirt deflector S26/S30-6	28-10162-6	35	\$1,019
dirt deflector S30-7	28-10162-7	40	\$500
<b>Side Mount Caster Wheels</b>			
side mount caster wheels S26	28-10498	45	\$1,589
side mount caster wheels S30	28-10499	55	\$2,701

# SWEEPERS

## COMPACT TRACTOR ANGLE SWEEPER- MECHANICAL PTO DRIVE (RMRM)



- Angles manually 30° left or right;
- Driven from rear 540 PTO
- Includes steel hood, chain shield, height adjustment chains & mounting pins
- T-Shaft gearbox allows for reversal of brush rotation on mechanical drive

### Specifications

Model #	Width	Path @ 30° Angle	Weight (approx)	Brush Diameter	Storage Stands
RMRM4	48"	40"	370 lbs	24"	optional
RMRM5	60"	52"	430 lbs	24"	optional
RMRM6	72"	64"	490 lbs	24"	optional

## COMPACT TRACTOR ANGLE SWEEPER - MECHANICAL PTO DRIVE (RMRM)



**TO ORDER: CHOOSE BRUSH HEAD & BRUSH MATERIAL AND MOUNTING DRIVE**

BRUSH HEAD AND BRUSH MATERIAL	ORDER CODE	SHIP WEIGHT (LBS)	LIST PRICE
<b>Mechanical Brush Head - All Polypropylene Brush</b>			
RM24 4 ft mechanical brush head	M24P4A	370	\$2,575
RM24 5 ft mechanical brush head	M24P5A	430	\$2,859
RM24 6 ft mechanical brush head	M24P6A	490	\$3,907
<b>Mechanical Brush Head - Polypropylene &amp; Wire Brush</b>			
RM24 4 ft mechanical brush head	M24C4A	370	\$2,622
RM24 5 ft mechanical brush head	M24C5A	430	\$2,859
RM24 6 ft mechanical brush head	M24C6A	490	\$3,907
MOUNTING & DRIVE (REQUIRED)	ORDER CODE	SHIP WEIGHT (LBS)	LIST PRICE
Category 1 3-Point mounting assembly	11-17383	135	\$5,219
OPTIONS	ORDER CODE	SHIP WEIGHT (LBS)	LIST PRICE
hydraulic angle no valve	11-4191	6	\$827
storage stands	13-0800	25	\$873
side mount caster wheels	28-9543	35	\$906

## UTILITY TRACTOR REAR MOUNT ANGLE SWEEPER - MECHANICAL 3-POINT DRIVE (RHFA)



- Angles manually 30° left or right;
- Driven from rear 540 PTO
- Includes steel hood, chain shield, height adjustment chains & mounting pins
- T-Shaft gearbox allows for reversal of brush rotation on mechanical drive
- Machine needs to be over 30HP

Specifications					
Model #	Width	Path @ 30° Angle	Weight (approx)	Brush Diameter	Storage Stands
RHFA5	60"	52"	750 lbs	32"	standard
RHFA6	72"	64"	850 lbs	32"	standard
RHFA7	84"	76"	950 lbs	32"	standard
RHFA8	96"	88"	1,050 lbs	32"	standard

## UTILITY TRACTOR REAR MOUNT ANGLE SWEEPER - MECHANICAL 3-POINT DRIVE (RHFA)



**TO ORDER: CHOOSE BRUSH HEAD & BRUSH MATERIAL, ANGLE AND MOUNTING**

BRUSH HEAD AND BRUSH MATERIAL	ORDER CODE	SHIP WEIGHT (LBS)	LIST PRICE
<b>Mechanical Brush Head - All Polypropylene Brush</b>			
RHFA 5 ft mechanical brush head	RHFA5P	750	\$8,732
RHFA 6 ft mechanical brush head	RHFA6P	850	\$8,732
RHFA 7 ft mechanical brush head	RHFA7P	950	\$9,327
RHFA 8 ft mechanical brush head	RHFA8P	1050	\$10,225
<b>Mechanical Brush Head - Polypropylene &amp; Wire Brush</b>			
RHFA 5 ft mechanical brush head	RHFA5M	750	\$8,732
RHFA 6 ft mechanical brush head	RHFA6M	850	\$8,732
RHFA 7 ft mechanical brush head	RHFA7M	950	\$9,327
RHFA 8 ft mechanical brush head	RHFA8M	1050	\$10,225
ANGLE MANUAL OR HYDRAULIC (ONE REQUIRED)	ORDER CODE	SHIP WEIGHT (LBS)	LIST PRICE
manual angle link	M	6	Included
hydraulic angle cylinder & 72" hose no valve, hydraulic couplers not included	H	20	\$750
MOUNTING (ONE REQUIRED)	ORDER CODE	SHIP WEIGHT (LBS)	LIST PRICE
Cat I & Cat II 3-Point Mounting Assembly	-0052	n/a	Included

Standardized mounting with the exception of ACS, CAT Fusion and Bobcat X-Change

# SWEEPERS

## UTILITY TRACTOR REAR MOUNT ANGLE SWEEPER - MECHANICAL 3-POINT DRIVE (RHFA) CONT.

SWEEPERS

OPTIONS	ORDER CODE	SHIP WEIGHT (LBS)	LIST PRICE
casters	13-1603	100	\$2,063
sight indicator flags	11-5897	10	\$252
sight indicator balls	28-9965	10	\$529
steel dirt deflector	RHFADD	75	\$992
rubber dirt deflector flap	28-9951	65	\$987
<b>Sprinkler System (select both items below to complete kit)</b>			
sprinkler system tank 25 gallon with mounting and shut off (Cat I only)	11-5739	75	\$1,250
sprinkler system no tank kit 12v for all lengths - field installed	28-9919*	25	\$1,356
sprinkler system pump, filter, nozzles 12V - factory installed	28-10114	25	\$1,356
<b>180 Hood - Factory Installed</b>			
for RHFA 5	28-9783	50	\$422
for RHFA 6	28-9784	55	\$373
for RHFA 7	28-9785	60	\$766
for RHFA 8	28-9786	65	\$944
<b>180 Hood - Field Installed</b>			
for RHFA 5	28-9722	50	\$458
for RHFA 6	28-9723	55	\$707
for RHFA 7	28-9724	60	\$766
for RHFA 8	28-9725	65	\$408

\*customer supplied water source or other suitable kit required

Add Surcharge to all products 8.5%

## UTILITY TRACTOR REAR MOUNT ANGLE SWEEPER - HYDRAULIC DRIVE (RLH)



- Drive slips easily out of core without removing hydraulic lines from wheel motor
- Brush core is reversible for even brush wear
- 32" diameter brush for longer life
- Angles manually 30° left/right
- Rear mount
- Sweep width 5' to 7'

Model	DM18		SM18		SM28		Width	Brush Diameter	Weight (Approx)
	GPM Range	PSI Range	GPM Range	PSI Range	GPM Range	PSI Range			
QC5	20-36	2000-3500	10-18	2000-3500	12-25	2000-3000	60"	32"	1090 lbs
QC6	20-36	2000-3500	10-18	2000-3500	12-25	2000-3000	72"	32"	1150 lbs
QC7	20-36	2000-3500	10-18	2000-3500	12-25	2000-3000	84"	32"	1210 lbs
QC8	20-36	2000-3500			12-25	2000-3000	96"	32"	1270 lbs
QC-9	20-36	2000-3500					108"	32"	1330 lbs

## UTILITY TRACTOR REAR MOUNT ANGLE SWEEPER - HYDRAULIC DRIVE (RLH)



**TO ORDER: CHOOSE BRUSH HEAD & BRUSH MATERIAL, ANGLE AND MOUNTING**

BRUSH HEAD AND BRUSH MATERIAL	ORDER CODE	SHIP WEIGHT (LBS)	LIST PRICE
<b>Brush Head with Single 18" Cubic Inch Motor (SM18) - 10-18 GPM, 2000-3500 PSI</b>			
<b>Hydraulic Drive Brush Head - All Polypropylene Brush</b>			
QC 5 ft hydraulic drive brush head	QC32P5SM18	383	\$5,539
QC 6 ft hydraulic drive brush head	QC32P6SM18	442	\$5,539
QC 7 ft hydraulic drive brush head	QC32P7SM18	505	\$5,691
QC 8 ft hydraulic drive brush head	QC32P8SM18	572	\$6,494
<b>Hydraulic Drive Brush Head - Polypropylene &amp; Wire Brush</b>			
QC 5 ft hydraulic drive brush head	QC32M5SM18	383	POR
QC 6 ft hydraulic drive brush head	QC32M6SM18	442	\$5,539
QC 7 ft hydraulic drive brush head	QC32M7SM18	505	\$5,691
QC 8 ft hydraulic drive brush head	QC32M8SM18	572	\$6,492
<b>Brush Head with Single 28" Cubic Inch Motor (SM28) - 12-25 GPM, 2000-3000 PSI</b>			
<b>Hydraulic Drive Brush Head - All Polypropylene Brush</b>			
QC 5 ft hydraulic drive brush head	QC32P5SM28	383	POR
QC 6 ft hydraulic drive brush head	QC32P6SM28	442	\$5,539
QC 7 ft hydraulic drive brush head	QC32P7SM28	505	\$5,691
QC 8 ft hydraulic drive brush head	QC32P8SM28	572	\$6,492
QC 9 ft hydraulic drive brush head	QC32P9SM28	639	POR
<b>Brush Head with Single 28" Cubic Inch Motor (SM28) - 12-25 GPM, 2000-3000 PSI cont.</b>			
<b>Hydraulic Drive Brush Head - Polypropylene &amp; Wire Brush</b>			
QC 5 ft hydraulic drive brush head	QC32M5SM28	383	\$5,539

BRUSH HEADS CONTINUED NEXT PAGE

# SWEEPERS

## UTILITY TRACTOR REAR MOUNT ANGLE SWEEPER - HYDRAULIC DRIVE (RLH) CONT.

BRUSH HEAD AND BRUSH MATERIAL CONT.	ORDER CODE	SHIP WEIGHT (LBS)	LIST PRICE
QC 6 ft hydraulic drive brush head	QC32M6SM28	442	\$5,539
QC 7 ft hydraulic drive brush head	QC32M7SM28	505	\$5,691
QC 8 ft hydraulic drive brush head	QC32M8SM28	572	\$6,494
QC 9 ft hydraulic drive brush head	QC32M9SM28	639	\$7,297
<b>Brush Head with Dual 18" Cubic Inch Motor (DM18) - 20-36 GPM, 2000-3500 PSI</b>			
<b>Hydraulic Drive Brush Head - All Polypropylene Brush</b>			
QC 5 ft hydraulic drive brush head	QC32P5DM18	383	POR
QC 6 ft hydraulic drive brush head	QC32P6DM18	442	\$7,557
QC 7 ft hydraulic drive brush head	QC32P7DM18	505	\$7,489
QC 8 ft hydraulic drive brush head	QC32P8DM18	572	\$8,300
QC 9 ft hydraulic drive brush head	QC32P9DM18	639	\$10,395
<b>Hydraulic Drive Brush Head - Polypropylene &amp; Wire Brush</b>			
QC 5 ft hydraulic drive brush head	QC32M5DM18	383	POR
QC 6 ft hydraulic drive brush head	QC32M6DM18	442	\$7,557
QC 7 ft hydraulic drive brush head	QC32M7DM18	505	\$7,489
QC 8 ft hydraulic drive brush head	QC32M8DM18	572	\$8,300
QC 9 ft hydraulic drive brush head	QC32M9DM18	639	\$10,395
ANGLE (MANUAL OR HYDRAULIC)	ORDER CODE	SHIP WEIGHT (LBS)	LIST PRICE
manual angle link	13-3406	15	\$277
Hydraulic angle cylinder & 72" hoses - no valve	11-4298	30	\$909
REAR 3-POINT MOUNTING CAT I OR II (ONE REQUIRED)	ORDER CODE	SHIP WEIGHT (LBS)	LIST PRICE
with broom driven by tractor hydraulics (Cat I)	11-5031	425	\$3,873
with 20 gpm hydraulic system for use with S28 & DM18 hydraulic motors (CAT I)	11-4202	625	\$8,940
with 20 gpm hydraulic system for use with S28 & DM18 hydraulic motors (CAT II)	11-5064	625	\$8,940
with 24 gpm pump (CAT II) 1000 pto	11-5065	625	\$8,940
with boom driven by tractor hydraulics (Cat II)	11-5045	325	\$3,873

OPTIONS CONTINUED NEXT PAGE

## UTILITY TRACTOR REAR MOUNT ANGLE SWEEPER - HYDRAULIC DRIVE (RLH) CONT.

OPTIONS	ORDER CODE	SHIP WEIGHT (LBS)	LIST PRICE
steel dirt deflector	RHFADD	75	\$992
rubber dirt deflector flap for tractor side of brush head	28-9951	65	\$987
<b>Sprinkler System (select both items below to complete kit)</b>			
sprinkler system tank 25 gallon with mounting and shutoff - CAT I only	11-5739	75	\$1,250
sprinkler system no tank kit 12V for all lengths - field installed	28-9919*	25	\$1,356
sprinkler system pump, filter, nozzles 12V - factory installed	28-10114	25	\$1,356
<b>180 Hood - Factory Installed</b>			
for RLH 5	28-10311-5	50	\$580
for RLH 6	28-10311-6	55	\$698
for RLH 7	28-10311-7	60	\$823
for RLH 8	28-10311-8	65	\$944
<b>180 Hood - Field Installed</b>			
for RLH 5	28-10361-5	50	\$572
for RLH 6	28-10361-6	55	\$698
for RLH 7	28-10361-7	60	\$823
for RLH 8	28-10361-8	65	\$944
<b>Drape Deflector Includes 180 Hood - Factory Installed</b>			
for RLH 5	28-10312-5	65	\$1,084
for RLH 6	28-10312-6	70	\$1,084
for RLH 7	28-10312-7	75	\$1,197
for RLH 8	28-10312-8	80	\$1,312
<b>Drape Deflector Includes 180 Hood - Field Installed</b>			
for RLH 5	28-10362-5	65	\$1,084
for RLH 6	28-10362-6	70	\$1,084
for RLH 7	28-10362-7	75	\$1,197
for RLH 8	28-10362-8	80	\$1,312

\*customer supplied water source or other suitable kit required

Add Surcharge to all products 8.85%

# SWEEPERS

## UTILITY TRACTOR ANGLE SWEEPER - PTO TO HYDRAULIC DRIVE (AH/CH)



- Drive slips easily out of core without removing hydraulic lines from wheel motor(s)
- Brush core is reversible for even brush wear
- 32" diameter brush for longer life
- Angles manually 30° left/right
- Front mount
- Sweep width for AH is 5' to 7', CH is 5' to 9'

Model	DM18		SM18		SM28		Width	Brush Diameter	Weight (Approx)
	GPM Range	PSI Range	GPM Range	PSI Range	GPM Range	PSI Range			
QC5	20-36	2000-3500	10-18	2000-3500	12-25	2000-3000	60"	32"	1090 lbs
QC6	20-36	2000-3500	10-18	2000-3500	12-25	2000-3000	72"	32"	1150 lbs
QC7	20-36	2000-3500	10-18	2000-3500	12-25	2000-3000	84"	32"	1210 lbs
QC8	20-36	2000-3500			12-25	2000-3000	96"	32"	1270 lbs
QC-9	20-36	2000-3500					108"	32"	1270 lbs

## UTILITY TRACTOR ANGLE SWEEPER - PTO TO HYDRAULIC DRIVE (AH/CH)



**TO ORDER: CHOOSE BRUSH HEAD & BRUSH MATERIAL, SWING ASSEMBLY, PUMP LOCATION AND MOUNTING**

BRUSH HEAD AND BRUSH MATERIAL	ORDER CODE	SHIP WEIGHT (LBS)	LIST PRICE
<b>BRUSH HEAD WITH SINGLE MOTOR - 10-18 GPM, 2000-3500 PSI</b>			
<b>Hydraulic Drive Brush Head - All Polypropylene Brush</b>			
QC 5 ft hydraulic drive brush head	QC32P5SM18	383	\$5,539
QC 6 ft hydraulic drive brush head	QC32P6SM18	442	\$5,539
QC 7 ft hydraulic drive brush head	QC32P7SM18	505	\$5,691
QC 8 ft hydraulic drive brush head	QC32P8SM18	572	\$6,494
<b>Hydraulic Drive Brush Head - Polypropylene &amp; Wire Brush</b>			
QC 5 ft hydraulic drive brush head	QC32M5SM18	383	POR
QC 6 ft hydraulic drive brush head	QC32M6SM18	442	\$5,539
QC 7 ft hydraulic drive brush head	QC32M7SM18	505	\$5,691
QC 8 ft hydraulic drive brush head	QC32M8SM18	572	\$6,492

BRUSH HEAD AND BRUSH MATERIAL CONTINUED NEXT PAGE

## UTILITY TRACTOR ANGLE SWEEPER - PTO TO HYDRAULIC DRIVE (AH/CH)

BRUSH HEAD AND BRUSH MATERIAL CONT.	ORDER CODE	SHIP WEIGHT (LBS)	LIST PRICE
<b>BRUSH HEAD WITH SINGLE MOTOR - 12-25 GPM, 2000-3000 PSI</b>			
<b>Hydraulic Drive Brush Head - All Polypropylene Brush</b>			
QC 5 ft hydraulic drive brush head	QC32P5SM28	383	POR
QC 6 ft hydraulic drive brush head	QC32P6SM28	442	\$5,539
QC 7 ft hydraulic drive brush head	QC32P7SM28	505	\$5,691
QC 8 ft hydraulic drive brush head	QC32P8SM28	572	\$6,492
QC 9 ft hydraulic drive brush head	QC32P9SM28	639	POR
<b>BRUSH HEAD WITH SINGLE MOTOR - 12-25 GPM, 2000-3000 PSI</b>			
<b>Hydraulic Drive Brush Head - Polypropylene &amp; Wire Brush</b>			
QC 5 ft hydraulic drive brush head	QC32M5SM28	383	\$5,539
QC 6 ft hydraulic drive brush head	QC32M6SM28	442	\$5,539
QC 7 ft hydraulic drive brush head	QC32M7SM28	505	\$5,691
QC 8 ft hydraulic drive brush head	QC32M8SM28	572	\$5,539
QC 9 ft hydraulic drive brush head	QC32M9SM28	639	\$7,297
<b>BRUSH HEAD WITH DUAL MOTOR - 20-36 GPM, 2000-3500 PSI</b>			
<b>Hydraulic Drive Brush Head - All Polypropylene Brush</b>			
QC 5 ft hydraulic drive brush head	QC32P5DM18	383	POR
QC 6 ft hydraulic drive brush head	QC32P6DM18	442	\$7,557
QC 7 ft hydraulic drive brush head	QC32P7DM18	505	\$7,489
QC 8 ft hydraulic drive brush head	QC32P8DM18	572	\$8,300
QC 9 ft hydraulic drive brush head	QC32P9DM18	639	\$10,395
<b>Hydraulic Drive Brush Head - Polypropylene &amp; Wire Brush</b>			
QC 5 ft hydraulic drive brush head	QC32M5DM18	383	POR
QC 6 ft hydraulic drive brush head	QC32M6DM18	442	\$7,557
QC 7 ft hydraulic drive brush head	QC32M7DM18	505	\$7,557
QC 8 ft hydraulic drive brush head	QC32M8DM18	572	\$8,300
QC 9 ft hydraulic drive brush head	QC32M9DM18	639	\$10,395
<b>SWING ASSEMBLY (ONE REQUIRED)</b>			
<b>Heavy Duty Plate Type Swing</b> Recommended when sweeping at less than a 30 degree angle			
offsets brush to the side, brush is angled	28-4612	290	\$3,295
<b>Scissor Type Swing</b>			
brush stays centered on vehicle when angle 30 degrees left or right	11-0790	282	\$3,786
<b>20 GPM PUMP LOCATION</b>			
Contact Customer Service for Mounting Availability			
rear PTO driven (standard)	RPD	n/a	POR
<b>MOUNTING (ONE REQUIRED)</b>			
Contact Customer Service for Mounting Availability			
<b>Tractor Mounting Assembly with Hydraulic System - Pump, Tank &amp; Valve Option</b>			
with manual lift, swing and run valves (not available for cab tractors)	MV	468	POR
with electric run valve for FPD mountings (lift & swing operated from tractor remotes)	RUV	468	POR
with electric valves lift, swing and run valves	EV	468	POR
with no valves Brush turned off with PTO (lift & swing operated from tractor remotes)	NV	468	POR

MOUNTING CONTINUED NEXT PAGE

# SWEEPERS

## UTILITY TRACTOR ANGLE SWEEPER - PTO TO HYDRAULIC DRIVE (AH/CH)

MOUNTING (ONE REQUIRED) CONT. Contact Customer Service for Mounting Availability		ORDER CODE	SHIP WEIGHT (LBS)	LIST PRICE
<b>Tractor Mounting Assembly Operated from Tractor Hydraulic System, Valve Option Only</b>				
with manual lift, swing and run valves (not available for cab tractors)		HMV	468	POR
with electric run valve (lift and swing operated from tractor remotes)		HRUV	468	POR
with electric valves lift, swing and run valves		HEV	468	POR
with no valves (run lift and swing operated with tractor remotes)		HNV	468	POR
OPTIONS		ORDER CODE	SHIP WEIGHT (LBS)	LIST PRICE
sight indicator flags		11-5897	10	\$252
sight indicators red balls		28-9965	10	\$529
bolt on stand kit front/rear		28-10315	60	\$270
<b>Sprinkler System (select one system and tank to complete kit)</b>				
sprinkler system fits all nozzles - mounts to hood, no tank 12V - field installed		28-9919*	25	\$1,356
sprinkler system pump, filter, nozzles 12V - factory installed		28-10114	25	\$1,356
sprinkler system tank 25 gallon with shut-off (no mount included - customer must make)		28-4319**	75	\$882
200 gallon 3-Point mounted water tank		11-5734	250	\$5,690
<b>180 Hood - Factory Installed</b>				
for QC-5		28-10311-5	50	\$580
for QC-6		28-10311-6	55	\$698
for QC-7		28-10311-7	60	\$823
for QC-8		28-10311-8	65	\$944
for QC-9		28-10311-9	70	\$952
<b>180 Hood - Field Installed</b>				
for QC-5		28-10361-5	50	POR
for QC-6		28-10361-6	55	\$698
for QC-7		28-10361-7	60	\$823
for QC-8		28-10361-8	65	\$944
for QC-9		28-10361-9	70	\$952
<b>Drape Deflector Includes 180 Hood - Factory Installed</b>				
for QC-5		28-10312-5	65	\$1,084
for QC-6		28-10312-6	70	\$1,084
for QC-7		28-10312-7	75	\$1,197
for QC-8		28-10312-8	80	\$1,312
for QC-9		28-10312-9	85	\$1,417
<b>Drape Deflector Includes 180 Hood - Field Installed</b>				
for QC-5		28-10362-5	65	\$1,084
for QC-6		28-10362-6	70	\$1,084
for QC-7		28-10362-7	75	\$1,197
for QC-8		28-10362-8	80	\$1,312
for QC-9		28-10362-9	85	\$1,417

\*customer supplied water source or other suitable kit required

\*\*customer supplied mounting system required (do not mount directly to sweeper hood)

## UTILITY TRACTOR LOADER ANGLE SWEEPER - HYDRAULIC DRIVE (QCTL)



- Drive slips out of core without removing hydraulic lines from wheel motor
- Brush core is reversible for even brush wear
- 32" diameter brush for longer life
- Angles manually 30° left/right
- Faceted hood design provides maximum strength at ends of the hood
- Choose poly or poly/wire brush

Specifications						
Model #	Width	Width @ 30°	Motors	Brush Diameter	Weight (approx.)	GPM Range
22059	60"	54"	single	32"	793	10-18
22060	60"	54"	single	32"	793	12-25
22061	60"	54"	dual	32"	829	18-36
22071	72"	64"	single	32"	852	10-18
22072	72"	64"	single	32"	852	12-25
22073	72"	64"	dual	32"	890	18-36
22083	84"	75"	single	32"	915	10-18
22084	84"	75"	single	32"	915	12-25
22085	84"	75"	dual	32"	953	18-36
22096	96"	85"	single	32"	982	12-25
22097	96"	85"	dual	32"	1,022	18-36

### HOW TO ORDER YOUR SWEEPER

**Step 1:**  
Choose Sweeper

**Step 2:**  
Choose Angle Control

**Step 3:**  
Choose Mount

example: 22060P + M + 0913 = 22060PM-0913

## UTILITY TRACTOR LOADER ANGLE SWEEPER - HYDRAULIC DRIVE (QCTL)



BRUSH HEAD AND BRUSH MATERIAL	ORDER CODE	SHIP WEIGHT (LBS)	LIST PRICE
<b>BRUSH HEAD WITH SINGLE MOTOR - 10-18 GPM, 2000-3500 PSI</b>			
<b>Brush Head with Single Motor - All Polypropylene Brush</b>			
QC 5 ft hydraulic drive brush head	22059P	793	\$7,910
QC 6 ft hydraulic drive brush head	22071P	852	\$8,425
QC 7 ft hydraulic drive brush head	22083P	915	\$8,966
<b>Brush Head with Single Motor - Polypropylene &amp; Wire Brush</b>			
QC 5 ft hydraulic drive brush head	22059M	793	\$7,910
QC 6 ft hydraulic drive brush head	22071M	852	\$8,425
QC 7 ft hydraulic drive brush head	22083M	915	\$8,966

# SWEEPERS

## UTILITY TRACTOR LOADER ANGLE SWEEPER - HYDRAULIC DRIVE (QCTL) CONT.

BRUSH HEAD AND BRUSH MATERIAL	ORDER CODE	SHIP WEIGHT (LBS)	LIST PRICE
<b>BRUSH HEAD WITH SINGLE MOTOR - 12-25 GPM, 2000-3000 PSI</b>			
<b>Brush Head with Single Motor - All Polypropylene Brush</b>			
QC 5 ft hydraulic drive brush head	22060P	831	\$7,910
QC 6 ft hydraulic drive brush head	22072P	890	\$8,425
QC 7 ft hydraulic drive brush head	22084P	953	\$8,966
QC 8 ft hydraulic drive brush head	22096P	1020	\$9,534
<b>Brush Head with Single Motor - Polypropylene &amp; Wire Brush</b>			
QC 5 ft hydraulic drive brush head	22060M	831	\$7,910
QC 6 ft hydraulic drive brush head	22072M	890	\$8,425
QC 7 ft hydraulic drive brush head	22084M	953	\$8,966
QC 8 ft hydraulic drive brush head	22096M	1020	\$9,534
<b>BRUSH HEAD WITH DUAL MOTOR - 20-36 GPM, 2000-3500 PSI</b>			
<b>Brush Head with Dual Motor - All Polypropylene Brush</b>			
QC 5 ft hydraulic drive brush head	22061P	831	\$7,910
QC 6 ft hydraulic drive brush head	22073P	890	\$8,425
QC 7 ft hydraulic drive brush head	22085P	953	\$8,966
QC 8 ft hydraulic drive brush head	22097P	1020	\$9,534
<b>Brush Head with Dual Motor - Polypropylene &amp; Wire Brush</b>			
QC 5 ft hydraulic drive brush head	22061M	831	\$7,910
QC 6 ft hydraulic drive brush head	22073M	890	\$8,425
QC 7 ft hydraulic drive brush head	22085M	953	\$8,966
QC 8 ft hydraulic drive brush head	22097M	1020	\$9,534
<b>ANGLE TYPE MANUAL OR HYDRAULIC (ONE REQUIRED)</b>			
<b>Contact Customer Service for Mounting Information on Specific Tractors</b>			
manual angle change	M	n/a	Included
hydraulic angle change with electric valve 12 volt	H	22	\$2,391
hydraulic angle change with electric valve 24 volt	H2	22	\$2,391
hydraulic angle change cylinder and 72" hoses	H3	10	\$445
hydraulic angle change cylinder and 144" hoses	H4	20	\$678
hydraulic angle change cylinder only - no hoses	H5	17	\$445
Bi-directional sweeping valve 12 volt	H6	22	\$2,391
<b>Hydraulic Angle Control Options (one required)</b>			
Control box w/ power lead	28-10754	5	\$383
5 ft of extra cable for H or H2	07-7155	2	\$311
<b>MOUNTING (ONE REQUIRED)</b>			
<b>Contact Customer Service for Mounting Availability</b>			
Standardized mounting with the exception of ACS, Balderson, CAT Fusion, Bobcat X-Change, JRB 420, and Volvo L150			\$1,592
OPTIONS CONTINUED NEXT PAGE			

## UTILITY TRACTOR LOADER ANGLE SWEEPER - HYDRAULIC DRIVE (QCTL) CONT.

OPTIONS	ORDER CODE	SHIP WEIGHT (LBS)	LIST PRICE
sight indicator flag	11-5897	10	\$252
sight indicator ball	28-9965	10	\$529
<b>Independent Hydraulic System</b>			
independent hydraulic system pump (rear PTO tank mount to 3-Point 20 GPM with pressure relief valve)	11-7691	150	\$5,168
quick coupler kit for 3-Point hydraulic system	28-10014	24	\$169
<b>Sprinkler Kits (select system and tank to complete kit)</b>			
pump filter nozzles sprinkler system fits all nozzles mounts to hood 12V - field installed	28-9919*	25	\$1,356
sprinkler system pump, filter, nozzles 12V - factory installed	28-10114	25	\$1,356
sprinkler system tank 25 gallon with shut-off	28-4319**	75	\$882
<b>180 Hood - Factory Installed</b>			
for QC-5	28-10311-5	50	\$580
for QC-6	28-10311-6	55	\$698
for QC-7	28-10311-7	60	\$823
for QC-8	28-10311-8	65	\$944
<b>180 Hood - Field Installed</b>			
for QC-5	28-10361-5	50	POR
for QC-6	28-10361-6	55	\$698
for QC-7	28-10361-7	60	\$823
for QC-8	28-10361-8	65	\$944
<b>Drape Deflector Includes 180 Hood - Factory Installed</b>			
for QC-5	28-10312-5	65	\$1,084
for QC-6	28-10312-6	70	\$1,084
for QC-7	28-10312-7	75	\$1,197
for QC-8	28-10312-8	80	\$1,312
<b>Drape Deflector Includes 180 Hood - Field Installed</b>			
for QC-5	28-10362-5	65	\$1,084
for QC-6	28-10362-6	70	\$1,084
for QC-7	28-10362-7	75	\$1,197
for QC-8	28-10362-8	80	\$1,312

\*customer supplied water source or other suitable kit required

\*\*customer supplied mounting system required (do not mount directly to sweeper hood)

# SWEEPERS

## SSL COLLECTOR SWEEPER - HYDRAULIC DRIVE (SB HOPPER)



Standard duty pickup cleanup

- Direct-drive motor powered from loader hydraulics
- 10-25 GPM flow required (2,000-3,500 psi)
- 26" brush diameter
- 5', 6', 7' brush widths available
- Brush head reversible for "dust-panning" debris
- Dump bucket by lifting arms
- Quick change core

### Specifications

Model #	Working Width	Overall Width	Weight (approx.)	Brush Diameter	Hopper Capacity	Min. Hydraulic Flow	Max. Hydraulic Flow	PSI Range
21559	60"	72.3"	808 lbs	26"	13.9 ft <sup>3</sup>	15 GPM	25 GPM	2000-3000
21560	60"	72.3"	955 lbs	26"	13.9 ft <sup>3</sup>	15 GPM	25 GPM	2000-3000
21571	72"	84.3"	916 lbs	26"	16.8 ft <sup>3</sup>	15 GPM	25 GPM	2000-3500
21572	72"	84.3"	1063 lbs	26"	16.8 ft <sup>3</sup>	15 GPM	25 GPM	2000-3500
21583	84"	96.3"	1033 lbs	26"	19.8 ft <sup>3</sup>	15 GPM	25 GPM	2000-3500
21584	84"	96.3"	1183 lbs	26"	19.8 ft <sup>3</sup>	15 GPM	25 GPM	2000-3500

## SSL COLLECTOR SWEEPER-HYDRAULIC DRIVE (SB HOPPER)



BRUSH HEAD AND BRUSH MATERIAL	ORDER CODE	SHIP WEIGHT (LBS)	LIST PRICE
<b>Brush Head - All Polypropylene Brush GPM Range 10-18</b>			
SB Hopper 5 ft hydraulic drive brush head	21559P-0022	808	POR
SB Hopper 6 ft hydraulic drive brush head	21571P-0022	916	\$7,485
SB Hopper 7 ft hydraulic drive brush head	21583P-0022	1033	POR
<b>Brush Head - Polypropylene &amp; Wire Brush</b>			
SB Hopper 5 ft hydraulic drive brush head	21559M-0022	808	\$6,750
SB Hopper 6 ft hydraulic drive brush head	21571M-0022	913	\$7,485
SB Hopper 7 ft hydraulic drive brush head	21583M-0022	1033	\$8,010
<b>Brush Head - All Polypropylene Brush GPM Range 15-25</b>			
SB Hopper 5 ft hydraulic drive brush head	21560P-0022	955	\$6,750
SB Hopper 6 ft hydraulic drive brush head	21572P-0022	1063	\$7,150
SB Hopper 7 ft hydraulic drive brush head	21584P-0022	1183	\$7,464
<b>Brush Head - Polypropylene &amp; Wire Brush</b>			
SB Hopper 5 ft hydraulic drive brush head	21560M-0022	955	\$6,750
SB Hopper 6 ft hydraulic drive brush head	21572M-0022	1063	\$7,150
SB Hopper 7 ft hydraulic drive brush head	21584M-0022	1183	\$7,464

## SSL COLLECTOR SWEEPER - HYDRAULIC DRIVE (SB HOPPER) CONT.

MOUNTING (ONE REQUIRED)	ORDER CODE	SHIP WEIGHT (LBS)	LIST PRICE
<b>Contact Customer Service for Mounting Availability</b>			
universal skid steer mounting SAE J2513	0022	n/a	POR
OPTIONS	ORDER CODE	SHIP WEIGHT (LBS)	LIST PRICE
<b>Sprinkler System</b>			
sprinkler kit 25 gallon tank 12 volt - factory installed	28-10136	47	\$1,896
sprinkler kit 25 gallon tank 24 volt - factory installed	28-10137	47	\$1,896
sprinkler kit 50 gallon tank 12 volt - factory installed	28-11100	-	\$2,646
sprinkler kit 50 gallon tank 24 volt - factory installed	28-11101	-	POR
sprinkler kit 25 gallon tank 12 volt - field installed	28-9139	47	\$1,896
sprinkler kit 25 gallon tank 24 volt - field installed	28-9193	47	\$1,896
sprinkler kit 50 gallon tank 12 volt - field installed	28-11098	-	\$2,639
sprinkler kit 50 gallon tank 24 volt - field installed	28-11099	-	POR
<b>Gutter Broom Kits</b>			
gutter broom kit poly brush - factory installed	28-10323-P	89	\$2,414
gutter broom kit wire brush - factory installed	28-10323-W	95	\$2,414
gutter broom shut off kit - factory installed	11-5449	20	\$719
gutter brush kit poly brush - field installed	28-10327-P	89	\$2,414
gutter brush kit wire brush - field installed	28-10327-W	95	\$2,414
gutter brush shut off kit - field installed	11-5449	20	\$719

## SSL PICKUP SWEEPER - HYDRAULIC DRIVE HEAVY-DUTY (SB HOPPER)



- Direct-drive motor powered from loader hydraulics
- 10-25 GPM flow required (2000-3500 psi)
- 26" brush diameter
- 5', 6', 7' brush widths available
- Brush head reversible for "dust panning" debris
- Dump bucket by lifting arms
- Quick change core

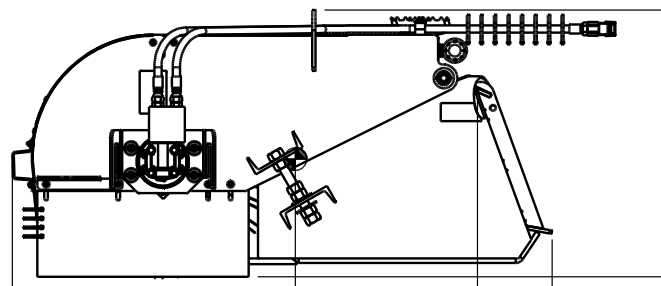

# SWEEPERS

## SSL PICKUP SWEEPER - HYDRAULIC DRIVE HEAVY-DUTY (SB HOPPER) CONT.



SWEEPERS

Specifications								
Model #	Working Width	Overall Width	Weight (approx.)	Brush Diameter	Hopper Capacity	Min. Hydraulic Flow	Max. Hydraulic Flow	PSI Range
21571-0022HD	72"	78"	1060 lbs	26"	16.8 ft <sup>3</sup>	10 GPM	14 GPM	2000-3500
21572-0022HD	72"	78"	1060 lbs	26"	16.8 ft <sup>3</sup>	18 GPM	25 GPM	2000-3500
21584-0022HD	84"	96.4"	1350 lbs	26"	19.8 ft <sup>3</sup>	15 GPM	25 GPM	2000-3500

## SSL PICKUP SWEEPER - HYDRAULIC DRIVE HEAVY-DUTY (SB HOPPER)



**TO ORDER: CHOOSE BRUSH HEAD & BRUSH MATERIAL.**  
**INCLUDES: BRUSH HEAD & BRUSH MATERIAL AND UNIVERSAL SSL MOUNTING**

BRUSH HEAD AND BRUSH MATERIAL	ORDER CODE	SHIP WEIGHT (LBS)	LIST PRICE
<b>Brush Head - All Polypropylene Brush GPM Range 10-18</b>			
SB Hopper 6 ft hydraulic drive brush head	21571P-0022HD	916	POR
<b>Brush Head - Polypropylene &amp; Wire Brush</b>			
SB Hopper 6 ft hydraulic drive brush head	21571M-0022HD	916	\$8,194
<b>Brush Head - All Polypropylene Brush GPM Range 15-25</b>			
SB Hopper 6 ft hydraulic drive brush head	21572P-0022HD	1063	POR
SB Hopper 7 ft hydraulic drive brush head	21584P-0022HD	1334	POR
<b>Brush Head - Polypropylene &amp; Wire Brush</b>			
SB Hopper 6 ft hydraulic drive brush head	21572M-0022HD	1063	\$8,604
SB Hopper 7 ft hydraulic drive brush head	21584M-0022HD	1334	\$8,671

MOUNTING (ONE REQUIRED)	ORDER CODE	SHIP WEIGHT (LBS)	LIST PRICE
<b>Contact Customer Service for Mounting Availability</b>			
heavy duty bucket option	-0022HD	varies	POR

OPTIONS	ORDER CODE	SHIP WEIGHT (LBS)	LIST PRICE
<b>Sprinkler System - Factory Installed</b>			
sprinkler kit 25 gallon tank 12 volt	28-10136	47	\$1,896
sprinkler kit 25 gallon tank 24 volt	28-10137	47	\$1,896
<b>Sprinkler System - Field Installed</b>			
sprinkler kit 25 gallon tank 12 volt	28-9139	47	\$1,896
sprinkler kit 25 gallon tank 24 volt	28-9193	47	\$1,896
<b>Gutter Broom Kits - Factory Installed</b>			
gutter broom kit poly brush	28-10323-P	89	\$2,414
gutter broom kit wire brush	28-10323-W	95	\$2,414
<b>Gutter Broom Kits - Field Installed</b>			
gutter broom kit poly brush	28-10327-P	89	\$2,414
gutter broom kit wire brush	28-10327-W	95	\$2,414
<b>Replacement Parts</b>			
0.63" x 6.0" edge for 60" bucket (11.25" bolt spacing)	28-10722-5	65	\$246
0.63" x 6.0" edge for 72" bucket (11.25" bolt spacing)	28-10722-6	77	\$269
0.63" x 6.0" edge for 84" bucket (11.25" bolt spacing)	28-10722-7	90	\$353

## SSL COLLECTOR SWEEPER-HYDRAULIC DRIVE COLD PLANER SPECIAL (SB HOPPER)

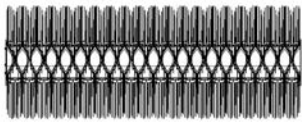

Standard 215 Core



Cold Planer Special

### Cold Planer Special Option

- Designed to clean up millings after cold planer operations
- Brush is operated in reverse to collect millings in bucket
- Brush sections are compacted dense-filled wafers optimized for clearing the millings

Specifications								
Model #	Working Width	Overall Width	Weight (approx.)	Brush Diameter	Heaped Capacity	Min. Hydraulic Flow	Max. Hydraulic Flow	PSI Range
21560P	60"	66"	955 lbs	26"	13.9 ft <sup>3</sup>	15 GPM	25 GPM	2000-3000
21572P	72"	78"	1063 lbs	26"	16.8 ft <sup>3</sup>	15 GPM	25 GPM	2000-3500
21584P	84"	90"	1183 lbs	26"	19.8 ft <sup>3</sup>	15 GPM	25 GPM	2000-3500

## SSL COLLECTOR SWEEPER-HYDRAULIC DRIVE COLD PLANER SPECIAL (SB HOPPER)



i

**TO ORDER: CHOOSE BRUSH HEAD & BRUSH MATERIAL, INCHES OF COMPACTED BRUSHES AND MOUNTING INCLUDES: BRUSH HEAD & BRUSH MATERIAL AND UNIVERSAL SSL MOUNTING**

BRUSH HEAD AND BRUSH MATERIAL	ORDER CODE	SHIP WEIGHT (LBS)	LIST PRICE
<b>Brush Head - All Polypropylene Brush GPM Range 15-25</b>			
SB Hopper 5 ft hydraulic drive brush head	21560P-0022	955	\$6,750
SB Hopper 6 ft hydraulic drive brush head	21572P-0022	1063	\$7,150
SB Hopper 7 ft hydraulic drive brush head	21584P-0022	1183	\$7,464

COLD PLANER SPECIAL SWEEPERS - USE AFTER MILLING, HEAVIER DESIGN WITH CENTER BRUSHES DENSELY PACKED		LIST PRICE
<b>Inches of Densely-Packed Center Brushes</b>		
16" - 36" (16", 18", 24", 30", 36")	specify inches	
>36" (40", 48", 60", 72", 84")	specify inches	

MOUNTING (ONE REQUIRED)	ORDER CODE	SHIP WEIGHT (LBS)	LIST PRICE
<b>Contact Customer Service for Mounting Availability</b>			
universal skid steer mounting SAE J2513	0022	n/a	

OPTIONS	ORDER CODE	SHIP WEIGHT (LBS)	LIST PRICE
<b>Sprinkler System</b>			
sprinkler kit 25 gallon tank 12 volt - factory installed	28-10136	47	\$1,896
sprinkler kit 25 gallon tank 24 volt - factory installed	28-10137	47	\$1,896
sprinkler kit 50 gallon tank 12 volt - factory installed	28-11100	-	\$2,646
sprinkler kit 50 gallon tank 24 volt - factory installed	28-11101	-	POR
sprinkler kit 25 gallon tank 12 volt - field installed	28-9139	47	\$1,896
sprinkler kit 25 gallon tank 24 volt - field installed	28-9193	47	\$1,896
sprinkler kit 50 gallon tank 12 volt - field installed	28-11098	-	\$2,639
sprinkler kit 50 gallon tank 24 volt - field installed	28-11099	-	POR
<b>Gutter Broom Kits</b>			
gutter broom kit poly brush - factory installed	28-10323-P	89	\$2,414
gutter broom kit wire brush - factory installed	28-10323-W	95	\$2,414
gutter broom kit poly brush - field installed	28-10327-P	89	\$2,414
gutter broom kit wire brush - field installed	28-10327-W	95	\$2,414
gutter broom shut off kit - field installed	11-5449	20	\$719

# SWEEPERS

## SSL COLLECTOR SWEEPER - HYDRAULIC DRIVE (VRS)



- Exclusive Volumizer™ feature increases bucket capacity 22%
- High dump design holds sweeper head clear of dumping bucket
- Quick change brush without breaking hydraulic lines
- Hydraulic motor can be removed for brush change without tools

### Specifications

Model #	Sweeping Width	Overall Width	Overall Length	Weight (approx.)	Hopper Capacity	GPM Range	PSI Range	Brush Diameter
VRS5	60"	76"	72.5"	1235 lbs	15 ft <sup>3</sup>	15-25	2000-3000	26"
VRS6	72"	88"	72.5"	1351 lbs	18 ft <sup>3</sup>	15-25	2000-3000	26"
VRS7	84"	100"	72.5"	1467 lbs	21 ft <sup>3</sup>	15-25	2000-3000	26"

## SSL COLLECTOR SWEEPER - HYDRAULIC DRIVE (VRS)



**TO ORDER: CHOOSE BRUSH HEAD & BRUSH MATERIAL AND MOUNTING  
INCLUDES: BRUSH HEAD & BRUSH MATERIAL AND UNIVERSAL SSL MOUNTING**

BRUSH HEAD AND BRUSH MATERIAL	ORDER CODE	SHIP WEIGHT (LBS)	LIST PRICE
<b>Hydraulic Drive Brush Head - All Polypropylene Brush</b>			
VRS 5 ft hydraulic drive brush head	VRS5P-0022	1235	\$8,005
VRS 6 ft hydraulic drive brush head	VRS6P-0022	1351	\$9,327
VRS 7 ft hydraulic drive brush head	VRS7P-0022	1467	\$11,709
<b>Hydraulic Drive Brush Head - Polypropylene and Wire Brush</b>			
VRS 5 ft hydraulic drive brush head	VRS5M-0022	1235	\$7,459
VRS 6 ft hydraulic drive brush head	VRS6M-0022	1351	\$8,691
VRS 7 ft hydraulic drive brush head	VRS7M-0022	1467	\$10,910

MOUNTING (ONE REQUIRED)	ORDER CODE	SHIP WEIGHT (LBS)	LIST PRICE
<b>Contact Customer Service for Additional Mounting Availability</b>			
universal skid steer mounting SAE J2513	0022	n/a	



**NOTE: Some skid steer loaders require special brackets supplied by the OEM manufacturer to attach the chains for the high dump feature. Check with the skid steer dealer for information on brackets required.**

OPTIONS	ORDER CODE	SHIP WEIGHT (LBS)	LIST PRICE
sprinkler kit without tank	28-9140	31	\$1,223
<b>Sprinkler System</b>			
sprinkler kit 25 gallon tank 12 volt - factory installed	28-10136	47	\$1,896
sprinkler kit 25 gallon tank 24 volt - factory installed	28-10137	47	\$1,896
sprinkler kit 50 gallon tank 12 volt - factory installed	28-11100	-	\$2,646
sprinkler kit 50 gallon tank 24 volt - factory installed	28-11101	-	POR
sprinkler kit 25 gallon tank 12 volt - field installed	28-9139	47	\$1,896
sprinkler kit 25 gallon tank 24 volt - field installed	28-9193	47	\$1,896
sprinkler kit 50 gallon tank 12 volt - field installed	28-11098	-	\$2,639
sprinkler kit 50 gallon tank 24 volt - field installed	28-11099	-	POR

OPTIONS CONTINUED NEXT PAGE

## SSL COLLECTOR SWEEPER - HYDRAULIC DRIVE (VRS) CONT.

OPTIONS CONT.	ORDER CODE	SHIP WEIGHT (LBS)	LIST PRICE
<b>Gutter Broom Assembly</b>			
gutter broom assembly poly - factory installed	28-10323-P	90	\$2,414
gutter broom assembly wire - factory installed	28-10323-W	90	\$2,414
dual gutter broom assembly poly - factory installed	28-10324-P	180	\$5,180
dual gutter broom assembly wire - factory installed	28-10324-W	180	\$5,180
gutter brush shut off kit - factory installed	11-5449	20	\$719
gutter broom assembly poly - field installed	28-10327-P	90	\$2,414
gutter broom assembly wire - field installed	28-10327-W	90	\$2,414

## SSL COLLECTOR SWEEPER WITH WATERLESS DUST ABATEMENT - HYDRAULIC DRIVE (VS)



- Patented waterless dust abatement
- Volumizer® Bar increases bucket capacity 22%
- High dump feature
- Heavy duty cleanup
- Brush automatically follows ground contour
- Powered from SSL hydraulics
- 15-25 GPM flow required
- 26" brush diameter
- 5', 6', 7' brush widths available
- Quick change core
- Tool-less brush adjustment



Motor and Fan Unit



Filter Unit



Shaker

Specifications										
Model #	Sweeping Width	Sweeping Width w/ Optional Gutter Brush	Overall Width	Overall Length	Overall Height	Weight (approx.)	Hopper Capacity	GPM Range	PSI Range	Maximum Back Pressure
VSS5	60"	72"	70.5"	69"	30"	1446 lbs	15 ft <sup>3</sup>	15-25	2000-3000	
VSS6	72"	84"	82.5"	69"	30"	1562 lbs	18 ft <sup>3</sup>	15-25	2000-3000	
VSS7	84"	96"	94.5"	69"	30"	1678 lbs	21 ft <sup>3</sup>	15-25	2000-3000	
Waterless Dust Abatement Attachment			59"	26.5"	6.5"	235 lbs				350 PSI

VS CONTINUED NEXT PAGE

# SWEEPERS

## SSL COLLECTOR SWEEPER WITH WATERLESS DUST ABATEMENT - HYDRAULIC DRIVE (VS) CONT.



**TO ORDER: CHOOSE BRUSH HEAD & BRUSH MATERIAL, MOUNTING AND FILTER SHAKER CONTROL SWITCH INCLUDES: BRUSH HEAD & BRUSH MATERIAL AND UNIVERSAL SSL MOUNTING**

BRUSH HEAD AND BRUSH MATERIAL	ORDER CODE	SHIP WEIGHT (LBS)	LIST PRICE
<b>Hydraulic Drive Brush Head - All Polypropylene Brush</b>			
5 ft hydraulic drive brush head	VSS5P-0022	1446	\$17,478
6 ft hydraulic drive brush head	VSS6P-0022	1562	\$19,065
7 ft hydraulic drive brush head	VSS7P-0022	1678	\$20,454
<b>Hydraulic Drive Brush Head - Polypropylene and Wire Brush</b>			
5 ft hydraulic drive brush head	VSS5M-0022	1446	\$17,478
6 ft hydraulic drive brush head	VSS6M-0022	1562	\$19,065
7 ft hydraulic drive brush head	VSS7M-0022	1678	\$20,454

MOUNTING (ONE REQUIRED) Contact Customer Service for Additional Mounting Availability	ORDER CODE	SHIP WEIGHT (LBS)	LIST PRICE
universal skid steer mounting SAE J2513	0022	n/a	



**NOTE: Some skid steer loaders require special brackets supplied by the OEM manufacturer to attach the chains for the high dump feature. Check with the skid steer dealer for information on brackets required.**

FILTER SHAKER CONTROL SWITCH (ONE REQUIRED)	ORDER CODE	SHIP WEIGHT (LBS)	LIST PRICE
Control box w/ power lead	28-10754	5	\$383
Wire Harness (multi function in cab controls) for CNH, JCB, Bobcat, Mustang, Kubota, Takeuchi, Volvo 14 Pin-8 Pin	LAF9360-0000	5	\$268
Wire harness for CNH (8-pin rectangular)	LAF9393	5	\$222
control wire harness for Komatsu 8 pin	07-10057	5	\$585
Wire harness for CAT pre-B (8-pin Deutsch)	07-10021	5	\$372
control wire harness for John Deere 14 pin	07-9437	5	\$1,012
5 ft of extra cable	07-7155	2	\$311

OPTIONS	ORDER CODE	SHIP WEIGHT (LBS)	LIST PRICE
<i>Note: Vacuum should not be used when operating gutter broom(s)</i>			
replacement vacuum filter	07-6679	n/a	\$614
<b>Gutter Broom Assembly - Factory Installed</b>			
gutter broom assembly poly	28-10323-P	90	\$2,414
gutter broom assembly wire	28-10323-W	90	\$2,414
dual gutter broom assembly poly	28-10324-P	180	\$5,180
dual gutter broom assembly wire	28-10324-W	180	\$5,180
<b>Gutter Broom Assembly - Field Installed</b>			
gutter broom assembly poly	28-10327-P	90	\$2,414
gutter broom assembly wire	28-10327-W	90	\$2,414



# SWEEPERS

## UTILITY TRACTOR LOADER COLLECTOR SWEEPER - HYDRAULIC DRIVE (CS) CONT.

BRUSH HEAD AND BRUSH MATERIAL CONT.			ORDER CODE	SHIP WEIGHT (LBS)	LIST PRICE
<b>26" DIAMETER BRUSH HEAD CONT.</b>					
<b>26" Diameter Brush Heads - Polypropylene &amp; Wire Brush - Single Motor</b>					
CS26 6 ft hydraulic bucket sweeper brush head	93"	0.4 yd <sup>3</sup>	20372M	1383	\$14,863
CS26 7 ft hydraulic bucket sweeper brush head	105"	0.53 yd <sup>3</sup>	20384M	1478	\$14,863
CS26 8 ft hydraulic bucket sweeper brush head	117"	0.61 yd <sup>3</sup>	20396M	1573	\$16,302
<b>26" Diameter Brush Heads - All Polypropylene Brush - Dual Motor</b>					
	<b>Overall Width</b>	<b>Hopper Capacity</b>	<b>GPM Range 26-50</b>		
CS26 6 ft hydraulic bucket sweeper brush head	93"	0.4 yd <sup>3</sup>	20373P	1418	\$14,863
CS26 7 ft hydraulic bucket sweeper brush head	105"	0.53 yd <sup>3</sup>	20385P	1513	\$14,863
CS26 8 ft hydraulic bucket sweeper brush head	117"	0.61 yd <sup>3</sup>	20397P	1608	\$16,302
<b>26" Diameter Brush Heads - Polypropylene &amp; Wire Brush - Dual Motor</b>					
CS26 6 ft hydraulic bucket sweeper brush head	93"	0.4 yd <sup>3</sup>	20373M	1418	\$14,863
CS26 7 ft hydraulic bucket sweeper brush head	105"	0.53 yd <sup>3</sup>	20385M	1513	\$14,863
CS26 8 ft hydraulic bucket sweeper brush head	117"	0.61 yd <sup>3</sup>	20397M	1608	\$16,302
<b>32" DIAMETER BRUSH HEAD</b>					
<b>32" Diameter Brush Heads - All Polypropylene Brush - Dual Motor</b>					
	<b>Overall Width</b>	<b>Hopper Capacity</b>	<b>GPM Range 26-50</b>		
CS32 8 ft hydraulic bucket sweeper brush head	117"	0.94 yd <sup>3</sup>	20497P	1837	\$25,268
CS32 9 ft hydraulic bucket sweeper brush head	129"	1.02 yd <sup>3</sup>	20409P	1948	\$28,070
<b>32" Diameter Brush Heads - Polypropylene &amp; Wire Brush - Dual Motor</b>					
CS32 8 ft hydraulic bucket sweeper brush head	117"	0.94 yd <sup>3</sup>	20497M	1837	\$25,268
CS32 9 ft hydraulic bucket sweeper brush head	129"	1.02 yd <sup>3</sup>	20409M	1948	\$28,070

MOUNTING (ONE REQUIRED)		ORDER CODE	SHIP WEIGHT (LBS)	LIST PRICE
<b>Contact Customer Service for Mounting Availability</b>				
various quick-attaches		varies	125	\$1,592
Standardized mounting with the exception of ACS, CAT Fusion and Bobcat X-Change				

OPTIONS		ORDER CODE	SHIP WEIGHT (LBS)	LIST PRICE
<b>Hose Kits - Hoses from the sweeper to the loader are not supplied. Hose packages available are listed below or the dealer can make up their own hoses. Hose quick couplers are not supplied.</b>				
3 ft CS hose kit .75" hoses FFS hose ends		28-10148-3	20	\$311
6 ft CS hose kit .75" hoses FFS hose ends		28-10148-6	23	\$512
9 ft CS hose kit .75" hoses FFS hose ends		28-10148-9	26	\$581
12 ft CS hose kit .75" hoses FFS hose ends		28-10148-12	29	\$699
<b>Sprinkler Kit - Without Tank - Factory Installed</b>				
sprinkler kit no tank includes pump, filter, nozzles, 12 volt		28-10114	30	\$1,356
sprinkler kit no tank includes pump, filter, nozzles, 24 volt		28-10115	30	\$1,516

OPTIONS CONTINUED NEXT PAGE

## UTILITY TRACTOR LOADER COLLECTOR SWEEPER - HYDRAULIC DRIVE (CS) CONT.

OPTIONS CONT.	ORDER CODE	SHIP WEIGHT (LBS)	LIST PRICE
<b>Sprinkler Kit - Without Tank - Field Installed</b>			
sprinkler kit no tank includes pump, filter, nozzles, 12 volt	28-9919*	30	\$1,356
sprinkler kit no tank includes pump, filter, nozzles, 24 volt	28-10116	30	\$1,782
<b>Sprinkler Kit - With Tank - Factory Installed</b>			
sprinkler kit includes 85 gallon tank 12 volt (only available for use with CS32)	28-10153	130	\$4,561
sprinkler kit includes 85 gallon tank 24 volt (only available for use with CS32)	28-10156	130	\$4,561
<b>Sprinkler Kit - With Tank - Field Installed</b>			
sprinkler kit includes 25 gallon tank 12 volt	28-9139	47	\$1,896
sprinkler kit includes 25 gallon tank 24 volt	28-9193	47	\$1,896
<b>Gutter Broom Assembly - Factory Installed</b>			
gutter broom single assembly poly	28-10118	90	\$3,587
gutter broom dual assembly poly	28-10120	180	\$7,176
gutter broom single assembly wire	28-10117	90	\$3,587
gutter broom dual assembly wire	28-10119	180	\$7,127

\*customer supplied water source or other suitable kit required

## UTILITY TRACTOR LOADER COLLECTOR SWEEPER WITH WATERLESS DUST ABATEMENT - HYDRAULIC DRIVE (VCS)



- Patented waterless dust abatement
- Heavy duty cleanup
- High dump feature activated by reversing flow
- Hopper positioned in front
- Powered from loader hydraulics
- 15-50 GPM flow required
- 26" and 32" brush diameter
- 6', 7', 8', 9' brush widths available
- Quick attach mount
- Quick change core

US PATENT NO: 7,928,596

Specifications							
Model	Sweeping Width	Overall Width	Weight (Approx)	Brush Diameter	Hopper Capacity	GPM Range	PSI Range
20374*	72"	93"	1100 lbs	26"	.4 yd <sup>3</sup>	15-25	2000-3500
20375*	72"	93"	1130 lbs	26"	.4 yd <sup>3</sup>	26-50	2000-3500
20386	84"	105"	1320 lbs	26"	.53 yd <sup>3</sup>	15-25	2000-3500
20387	84"	105"	1350 lbs	26"	.53 yd <sup>3</sup>	26-50	2000-3500
20398	96"	117"	1540 lbs	26"	.61 yd <sup>3</sup>	15-25	2000-3500
20399	96"	117"	1570 lbs	26"	.61 yd <sup>3</sup>	26-50	2000-3500
20499	96"	117"	1835 lbs	32"	.91 yd <sup>3</sup>	26-50	2000-3500
20411	108"	129"	2048 lbs	32"	1.02 yd <sup>3</sup>	26-50	2000-3500

\* 6 ft sweepers require minimum 2500 lb lift capacity

VCS CONTINUED NEXT PAGE

# SWEEPERS

## UTILITY TRACTOR LOADER COLLECTOR SWEEPER WITH WATERLESS DUST ABATEMENT - HYDRAULIC DRIVE (VCS) CONT.



**TO ORDER: CHOOSE BRUSH HEAD & BRUSH MATERIAL, FILTER SHAKER CONTROL ASSEMBLY AND MOUNTING**



**NOTE: 6 ft sweepers require minimum 2500 lb lift capacity; 7-9 ft sweepers are not available for Skid-Steers; Hoses from sweeper to the loader are not supplied; Hose quick couplers are not supplied.**

BRUSH HEAD AND BRUSH MATERIAL		ORDER CODE	SHIP WEIGHT (LBS)	LIST PRICE
<b>26" DIAMETER BRUSH HEAD</b>				
<b>26" Diameter Brush Heads - All Polypropylene Brush - Single Motor</b>	Overall Width	Hopper Capacity	GPM Range 15-25	
VCS26 6 ft hydraulic bucket sweeper brush head *	93"	0.4 yd <sup>3</sup>	20374SP	1623 \$28,528
VCS26 7 ft hydraulic bucket sweeper brush head	105"	0.53 yd <sup>3</sup>	20386SP	1718 \$28,528
VCS26 8 ft hydraulic bucket sweeper brush head	117"	0.61 yd <sup>3</sup>	20398SP	1813 \$29,733
<b>26" Diameter Brush Heads - Polypropylene &amp; Wire Brush - Single Motor</b>				
VCS26 6 ft hydraulic bucket sweeper brush head *	93"	0.4 yd <sup>3</sup>	20374SM	1623 \$28,528
VCS26 7 ft hydraulic bucket sweeper brush head	105"	0.53 yd <sup>3</sup>	20386SM	1718 \$28,528
VCS26 8 ft hydraulic bucket sweeper brush head	117"	0.61 yd <sup>3</sup>	20398SM	1813 \$29,733
<b>26" Diameter Brush Heads - All Polypropylene Brush - Dual Motor</b>	Overall Width	Hopper Capacity	GPM Range 26-50	
VCS26 6 ft hydraulic bucket sweeper brush head *	93"	0.4 yd <sup>3</sup>	20375SP	1658 \$30,060
VCS26 7 ft hydraulic bucket sweeper brush head	105"	0.53 yd <sup>3</sup>	20387SP	1753 \$30,060
VCS26 8 ft hydraulic bucket sweeper brush head	117"	0.61 yd <sup>3</sup>	20399SP	1848 \$31,265
<b>26" Diameter Brush Heads - Polypropylene &amp; Wire Brush - Dual Motor</b>				
VCS26 6 ft hydraulic bucket sweeper brush head *	93"	0.4 yd <sup>3</sup>	20375SM	1658 \$30,060
VCS26 7 ft hydraulic bucket sweeper brush head	105"	0.53 yd <sup>3</sup>	20387SM	1753 \$30,060
VCS26 8 ft hydraulic bucket sweeper brush head	117"	0.61 yd <sup>3</sup>	20399SM	1848 \$31,265
<b>32" DIAMETER BRUSH HEAD</b>				
<b>32" Diameter Brush Heads - All Polypropylene Brush - Dual Motor</b>	Overall Width	Hopper Capacity	GPM Range 26-50	
VCS32 8 ft hydraulic bucket sweeper brush head	117"	0.94 yd <sup>3</sup>	20411SP	2153 \$34,665
VCS32 9 ft hydraulic bucket sweeper brush head	129"	1.02 yd <sup>3</sup>	20411SP	2287 \$36,154
<b>32" Diameter Brush Heads - Polypropylene &amp; Wire Brush - Dual Motor</b>				
VCS32 8 ft hydraulic bucket sweeper brush head	117"	0.94 yd <sup>3</sup>	20499SM	2153 \$34,665
VCS32 9 ft hydraulic bucket sweeper brush head	129"	1.02 yd <sup>3</sup>	20411SM	2287 \$36,154
<b>FILTER SHAKER CONTROL ASSEMBLY (ONE REQUIRED)</b>		ORDER CODE	SHIP WEIGHT (LBS)	LIST PRICE
12 VDC Filter Shaker Assembly (Standard configuration)		H	n/a	Included
24 VDC Filter Shaker Assembly (Select only if 24 VDC is required)		H2	n/a	Included
<b>MOUNTING (ONE REQUIRED)</b>		ORDER CODE	SHIP WEIGHT (LBS)	LIST PRICE
<b>Contact Customer Service for Mounting Availability</b>				
various quick-attaches		varies	125	\$1,592
Standardized mounting with the exception of ACS, CAT Fusion and Bobcat X-Change				

VCS CONTINUED NEXT PAGE

## UTILITY TRACTOR LOADER COLLECTOR SWEEPER WITH WATERLESS DUST ABATEMENT - HYDRAULIC DRIVE (VCS) CONT.

OPTIONS	ORDER CODE	SHIP WEIGHT (LBS)	LIST PRICE
replacement vacuum filter	07-6679	n/a	\$614
Hose Kits - Hoses from the sweeper to the loader are not supplied. Hose packages available are listed below or the dealer can make up their own hoses. Hose quick couplers are not supplied.			
3 ft CS hose kit .75" hoses FFS hose ends	28-10148-3	20	POR
6 ft CS hose kit .75" hoses FFS hose ends	28-10148-6	23	\$512
9 ft CS hose kit .75" hoses FFS hose ends	28-10148-9	26	\$581
12 ft CS hose kit .75" hoses FFS hose ends	28-10148-12	29	\$699
<b>Gutter Broom Assembly - Factory Installed</b>			
gutter broom single assembly poly	28-10118	90	\$3,587
gutter broom dual assembly poly	28-10120	180	\$7,176
gutter broom single assembly wire	28-10117	90	\$3,587
gutter broom dual assembly wire	28-10119	180	\$7,127

Add Surcharge to all products 8.85%

# SWEEPERS

## REPLACEMENT BRUSHES

Palletization is Available on Brush LIST PRICES.  
Contact Sweepster for Additional Cost.



Poly



Wire



Poly/Wire



SWEEPERS

### MECHANICAL DRIVE ANGLE SWEEPERS

Model Description	Model Name / Series	Brush Head / Order Code	Section Size (IDxOD)	Individual Section		Packs (qty of 24/25)		Complete Set		
				Poly	Mixed (Poly / Wire)	Poly	Mixed (Poly / Wire)	Poly	Set Qty	Mixed (Poly / Wire)
Commercial Turf Mower Angle Sweeper Mechanical Drive	CTM	M24P4A	6.38x24	01-5009C \$16		01-5009C-25		01-0001C \$338	24	
		M24P5A						01-0017C \$417	31	
		M24P6A						01-0537C \$509	38	
		M24C4A		01-5009C \$16	01-0015C (wire only) \$24	01-5009C-25	01-0015C-24		13P/11W	01-0013C \$423
		M24C5A							16P/15W	01-0019C \$539
		M24C6A							20P/18W	01-0539C \$646
Compact Tractor Angle Sweeper Mechanical Drive PTO	RMRM	M24P4A	6.38x24	01-5009C \$16		01-5009C-25		01-0001C \$338	24	
		M24P5A						01-0017C \$417	31	
		M24P6A						01-0537C \$509	38	
		M24C4A		01-5009C \$16	01-0015C (wire only) \$24	01-5009C-25	01-0015C-24		13P/11W	01-0013C \$423
		M24C5A							16P/15W	01-0019C \$539
		M24C6A							20P/18W	01-0539C \$646
Utility Tractor Rear Mount Angle Sweeper Mechanical Drive PTO	RHFA	RHFA5	10x32	01-5002C \$16	01-5878 \$29	01-5002C-25	01-5878-24	01-1210-5 \$823	29	01-1209-5 \$878
		RHFA6						01-1210-6 \$POR	35	01-1209-6 \$942
		RHFA7						01-1210-7 \$865	41	01-1209-7 \$1,087
		RHFA8						01-1210-8 \$1,310	47	01-1209-8 \$1,402

REPLACEMENT BRUSHES CONTINUED NEXT PAGE

## REPLACEMENT BRUSHES CONT.

HYDRAULIC DRIVE ANGLE SWEEPERS										
Model Description	Model Name / Series	Brush Head / Order Code	Section Size (IDxOD)	Individual Section		Packs (qty of 24/25)		Complete Set		
				Poly	Mixed (Poly / Wire)	Poly	Mixed (Poly / Wire)	Poly	Set Qty	Mixed (Poly / Wire)
Commercial Turf Mower Angle Sweeper Hydraulic Drive	CTH	S26-4	8x26	01-5210 \$19	01-5010 \$22	01-5210-25	01-5010-24	01-0872 \$440	26	01-1158 \$536
		S26-5						01-1161 \$787	35	01-1167 \$625
		S26-6						01-1162 \$610	41	01-1168 \$734
Compact Tractor Loader Angle Sweeper Hydraulic Drive	MRHL	S26-4	8x26	01-5210 \$19	01-5010 \$22	01-5210-25	01-5010-24	01-0872 \$440	26	01-1158 \$536
		S26-5						01-1161 \$787	35	01-1167 \$625
		S26-6						01-1162 \$610	41	01-1168 \$734
	S30-4	8x30	01-5011 \$26	01-5012 \$23						
	S30-5									
	S30-6									
	S30-7									

REPLACEMENT BRUSHES CONTINUED NEXT PAGE

Add Surcharge to all products @ 5%

# SWEEPERS

## REPLACEMENT BRUSHES CONT.

SWEEPERS

HYDRAULIC DRIVE ANGLE SWEEPERS											
Model Description	Model Name / Series	Brush Head / Order Code	Section Size (IDxOD)	Individual Section		Packs (qty of 24/25)		Complete Set			
				Poly	Mixed (Poly / Wire)	Poly	Mixed (Poly / Wire)	Poly	Set Qty	Mixed (Poly / Wire)	
Compact Tractor Angle Sweeper Hydraulic Drive	MRH	S26-4	8x26	01-5210 \$19	01-5010 \$22	01-5210-25	01-5010-24	01-0872 \$440	26	01-1158 \$536	
		S26-5						01-1161 \$787	35	01-1167 \$625	
		S26-6						01-1162 \$610	41	01-1168 \$734	
		S30-4	8x30	01-5011 \$26	01-5012 \$23						
		S30-5									
		S30-6									
		S30-7									
SSL Angle Sweeper Hydraulic Drive	QCSS / 220	QC5	10x32	01-5002C \$27	01-5878 \$29	01-5002C-25	01-5878-24	01-1210-5 \$823	29	01-1209-5 \$878	
		QC6						01-1210-6 \$POR	35	01-1209-6 \$942	
		QC7						01-1210-7 \$865	41	01-1209-7 \$1,087	
		QC8						01-1210-8 \$1,310	47	01-1209-8 \$1,402	
Utility Tractor Rear Mount Angle Sweeper Hydraulic Drive PTO	RLH	QC5	10x32	01-5002C \$27	01-5878 \$29	01-5002C-25	01-5878-24	01-1210-5 \$823	29	01-1209-5 \$878	
		QC6						01-1210-6 \$POR	35	01-1209-6 \$942	
		QC7						01-1210-7 \$865	41	01-1209-7 \$1,087	
		QC8						01-1210-8 \$1,310	47	01-1209-8 \$1,402	
		QC9						01-1210-9 \$1,514	53	01-1209-9 \$1,483	
Utility Tractor Loader Angle Sweeper Hydraulic Drive	QCTL / 220	QC5	10x32	01-5002C \$27	01-5878 \$29	01-5002C-25	01-5878-24	01-1210-5 \$823	29	01-1209-5 \$878	
		QC6						01-1210-6 \$POR	35	01-1209-6 \$942	
		QC7						01-1210-7 \$865	41	01-1209-7 \$1,087	
		QC8						01-1210-8 \$1,310	47	01-1209-8 \$1,402	
		QC9						01-1210-9 \$1,514	53	01-1209-9 \$1,483	

REPLACEMENT BRUSHES CONTINUED NEXT PAGE

## REPLACEMENT BRUSHES CONT.

HYDRAULIC DRIVE ANGLE SWEEPERS										
Model Description	Model Name / Series	Brush Head / Order Code	Section Size (IDxOD)	Individual Section		Packs (qty of 24/25)		Complete Set		
				Poly	Mixed (Poly / Wire)	Poly	Mixed (Poly / Wire)	Poly	Set Qty	Mixed (Poly / Wire)
Utility Tractor Angle Sweeper Hydraulic Drive PTO	AH/CH	QC5	10x32	01-5002C \$27	01-5878 \$29	01-5002C-25	01-5878-24	01-1210-5 \$823	29	01-1209-5 \$878
		QC6						01-1210-6 \$POR	35	01-1209-6 \$942
		QC7						01-1210-7 \$865	41	01-1209-7 \$1,087
		QC8						01-1210-8 \$1,310	47	01-1209-8 \$1,402
Truck and Wheel Loader Angle Sweeper Hydraulic Drive	LA / 221	QC8	10x32	01-5002C \$27	01-5878 \$29	01-5002C-25	01-5878-24*	01-1210-8 \$1,310	47	01-1209-9 \$1,483
		QC9						01-1210-9 \$1,514	53	01-1209-9 \$1,483
Truck and Large Wheel Loader Angle Sweeper Hydraulic Drive	WLA / 223	WLA10	10x36	01-5003C \$27	01-5014C \$34	01-5003C-25	01-5014C-25	01-1212-10 \$1,300	58	01-1211-10 \$1,765
		WLA12						01-1212-12 \$1,689	70	01-1211-12 \$2,088

HYDRAULIC DRIVE PICK-UP SWEEPERS										
Model Description	Model Name / Series	Brush Head / Order Code	Section Size (IDxOD)	Individual Section		Packs (qty of 24/25)		Complete Set		
				Poly	Mixed (Poly / Wire)	Poly	Mixed (Poly / Wire)	Poly	Set Qty	Mixed (Poly / Wire)
SSL Collector Sweeper Hydraulic Drive	SB / 215	21560	8x26	01-5210 \$19	01-5010 \$22	01-5210-25	01-5010-24	01-1161 \$787	35	01-1167 \$625
		21572						01-1162 \$610	41	01-1168 \$734
		21584						01-9279 \$1,080	47	01-9278 \$1,146
SSL Collector Sweeper Hydraulic Drive	VRS	VRS5	8x26	01-5210 \$19	01-5010 \$22	01-5210-25	01-5010-24	*01-1161 \$787	35	01-1167 \$625
		VRS6						*01-1162 \$610	41	01-1168 \$734
		VRS7						*01-9279 \$1,080	47	01-9278 \$1,146
SSL Collector Sweeper Hydraulic Drive w/ Dust Abatement System	VSS	VSS5	8x26	01-5210 \$19	01-5010 \$22	01-5210-25	01-5010-24	*01-1161 \$787	35	01-1167 \$625
		VSS6						*01-1162 \$610	41	01-1168 \$734
		VSS7						*01-9279 \$1,080	47	01-9278 \$1,146
Utility Tractor Loader Collector Sweeper Hydraulic Drive	CS26 / 203	20372	8x26	01-5210 \$19	01-5010 \$22	01-5210-25	01-5010-24	01-1161 \$787	35	01-1167 \$625
		20384						01-1162 \$610	41	01-1168 \$734
		20396						01-9279 \$1,080	47	01-9278 \$1,146

REPLACEMENT BRUSHES CONTINUED NEXT PAGE

# SWEEPERS

## REPLACEMENT BRUSHES CONT.

SWEEPERS

### HYDRAULIC DRIVE PICK-UP SWEEPERS

Model Description	Model Name / Series	Brush Head / Order Code	Section Size (IDxOD)	Individual Section		Packs (qty of 24/25)		Complete Set		
				Poly	Mixed (Poly / Wire)	Poly	Mixed (Poly / Wire)	Poly	Set Qty	Mixed (Poly / Wire)
Utility Tractor Loader Collector Sweeper Hydraulic Drive	CS32 / 204	20497	10x32	01-5002C \$27	01-5878 \$29	01-5002C-25	01-5878-24	*01-1210-8 \$1,310	47	*01-1209-8
		20409						*01-1210-9 \$1,514	53	*01-1209-9
Utility Tractor Loader Collector Sweeper Hydraulic Drive	VCS26 / 203	20372	8x26	01-5210 \$19	01-5010 \$22	01-5210-25	01-5010-24	01-1161 \$787	35	01-1167
		20384						01-1162 \$610	41	01-1168
		20396						01-9279 \$1,080	47	01-9278
Utility Tractor Loader Collector Sweeper Hydraulic Drive	VCS32 / 204	20497	10x32	01-5002C \$27	01-5878 \$29	01-5002C-25	01-5878-24	01-1210-8 \$1,310	47	01-1209-8
		20409						01-1210-9 \$1,514	53	01-1210-9

### \*BRUSH REPLACEMENT SUPERCESSION

Current Set	Superseded Set(s)	Current Set	Superseded Set(s)	Current Set	Superseded Set(s)
*01-1209-5	01-0274C	*01-1210-5	01-0272C	*01-9270	01-0716
*01-1209-6	01-0022C	*01-1210-6	01-0020C	*01-9271	01-0715
*01-1209-7	01-0081C	*01-1210-7	01-0079C	*01-1161	01-0873, 01-0851
*01-1209-8	01-0933, 01-0082C	*01-1210-8	01-0080C	*01-1162	01-9370, 01-0853
*01-1209-9	01-1148, 01-9279	*01-1210-9	01-0530C	*01-1167	01-1156, 01-9274
				*01-1168	01-9371
				*01-9279	01-1163
				*01-9278	01-1169

## TILLERS



- Efficiently breaks up sod and clumps of soil, mixes in compost, prepares soil for seeding
- Hardened, replaceable tines cut 6" deep
- Bi-directional shaft undercuts and top cuts in both directions of travel
- Works next to walls, fences and other obstacles

Carrier Specifications	
Lift Capacity	Operating Weight
<9,000 lbs.	<11,000 lbs.

## TILLERS



**INCLUDES: TILLER AND UNIVERSAL SSL MOUNTING**



TILLER			
CHECK LOADER CAPACITY BEFORE ORDERING	ORDER CODE	SHIP WEIGHT (LBS)	LIST PRICE
<b>Fixed Offset</b>			
52" working width Tiller	LAF3452-0022	620	\$7,339
68" working width Tiller	LAF3468-0022	715	\$7,760
<b>Adjustable offset - Tiller offsets to cover right tire</b>			
<b>52" Tiller</b>			
6" tines, 14 to 17 GPM	102000-D6-0022	660	\$9,696
6" tines, 18 to 28 GPM	102000-E6-0022	660	\$9,696
<b>68" Tiller</b>			
6" tines, 14 to 17 GPM	100935-D6-0022	880	\$8,795
6" tines, 18 to 28 GPM	100935-E6-0022	880	\$8,196
6" tines, 29 to 44 GPM	100935-H6-0022	880	\$9,836
<b>78" Tiller</b>			
6" tines, 29 to 44 GPM	103286-H6-0022	1110	\$10,391

OPTIONAL - ACCESSORIES			
	ORDER CODE	SHIP WEIGHT (LBS)	LIST PRICE
<b>Scarifiers</b>			
scarifier kit 52" set of 4	102071	40	\$680
scarifier kit 68" set of 5	102072	50	\$609
scarifier kit 78" set of 6	102307	60	\$674

# TREE TOOLS

## TREE FORKS



- Position plants, trees, & large shrubs quickly and with ease
- Will grasp up to 44" tree balls
- 6" tread plate on forks to firmly grip bags, boxes, pots, and rocks
- 3,000 lb. carrying capacity



## TREE FORKS

TREE FORKS	ORDER CODE	SHIP WEIGHT (LBS)	LIST PRICE
tree fork universal mount	101502	630	\$5,141
66" hoses flat face couplers	103577	10	\$365
94" hoses flat face couplers	103603	10	\$305

OPTIONAL	ORDER CODE	SHIP WEIGHT (LBS)	LIST PRICE
pressure control valve kit	107016	40	\$632

## TREE SCOOP



- Transports and places trees and shrubbery
- Digs holes for incoming trees
- Efficiently removes tree stumps
- Perfect for placing large decorative rocks and stones
- .375" plate with sharp, tapered edge

Carrier Specifications	
Lift Capacity	Operating Weight
<10,000 lbs.	<32,000 lbs.



## TREE SCOOP

**i** INCLUDES: SCOOP AND UNIVERSAL SSL MOUNTING  
TO ORDER: CHOOSE SCOOP AND MOUNTING

TREE SCOOP	ORDER CODE	SHIP WEIGHT (LBS)	LIST PRICE
36" Ball Size Tree Scoop	LAF1836-0022	278	\$2,163
42" Ball Size Tree Scoop	LAF1842-0022	380	\$2,293
48" Ball Size Tree Scoop	LAF1848-0022	445	\$2,511

MOUNTING - ADDITIONAL COST MAY APPLY	ORDER CODE	SHIP WEIGHT (LBS)
Contact Customer Service at (833) 723-1843		

## TREE SPADE



- Available in 2 series:  
25° modified truncated series  
30° cone model
- Standard electric control joystick to function the hydraulic valve
- Overlapping blades to clean cut roots
- Adjustable legs slide to control ball depth
- Wide gate opening to engage tree easily

Specifications								
Model	Overall Height	Overall Width	Digging Depth	Blades	Ball Dia.	Blade Angle	Ball Weight	Weight w/o chain (lbs)
2030	42"	46"	16"	3	16" - 20"	30°	80 - 120 lbs	650
2625	48"	56"	22"	3	18" - 26"	25°	150 - 350 lbs	1150
3625	65"	66"	31"	3	24" - 36"	25°	250 - 1000 lbs	1550
4425	65"	63"	31"	4	32" - 44"	25°	1200 - 1500 lbs	1825

## TREE SPADE



**INCLUDES: TREE SPADE AND UNIVERSAL SSL MOUNTING  
TO ORDER: CHOOSE SPADE, BLADE SET (IF REQUIRED) AND MOUNTING**



**NOTE: Consult Factory for specific mounts. See specs to determine spade size and machine capacity requirement.**

TREE SPADE WITH ELECTRIC VALVE & JOYSTICK CONTROL				ORDER CODE	SHIP WEIGHT (LBS)	LIST PRICE
<b>Tree Spade</b>						
2030 model with blade (mount required)				25605	650	\$11,933
<b>25 Series - (includes blades) (no under cutter)</b>						
2625 model 25° with blades*				25670	1150	\$13,017
3625 model 25° with blades*				25370	1550	\$19,068
4425 model 25° with blades*				25570	1875	\$24,152
OPTIONS				ORDER CODE	SHIP WEIGHT (LBS)	LIST PRICE
12' long control cable extension cord for use on tractor and wheel loader mounts				25519	10	\$711
16' long control cable extension cord for use on tractor and wheel loader mounts				25874	10	\$773
25' long control cable extension cord for use on tractor and wheel loader mounts				25869	10	\$923
replaceable joystick included in base unit				25425	10	\$2,568
MOUNTS FOR 2030 (INCLUDES HYDRAULIC KIT)				ORDER CODE	SHIP WEIGHT (LBS)	LIST PRICE
mini loader universal mount for 2030				25608	68	\$538
universal skid steer mount for 2030				25696	250	\$805
ASV RC30 / Polaris ASL 300 / Polaris				25744	150	\$912
Bobcat MT50 / MT52 mount for 2030				25689	150	\$854

Add Surcharge to all products 8.85%

# TRENCHERS



# TRENCHERS

**Bradco Trenchers**, by Paladin, can mount to skid-steer loaders, compact skid-steer loaders and 3-point PTO HP hydrostatic tractors. Several boom lengths are available to match your job's specifications.



## HOW TO ORDER AN ATTACHMENT

Since many of our attachments are customized to your needs, when you place your order you will need to choose your attachment, the mounting, and any options you would like. As you look through the products, notice the red headings in the charts - they will alert you to the choices you need to make.

Choose your attachment

TRENCHER ASSEMBLY (INCLUDES 4 FOOT HOSES WITH 6 FJX HOSE END)	ORDER CODE	SHIP WEIGHT (LBS)
330 trencher assembly, 15 - 30 HP	11135	465

Choose assemblies

BOOM & CRUMBER ASSEMBLIES	ORDER CODE	SHIP WEIGHT (LBS)
30" digging depth (29 stations)	111385	85
36" digging depth (32 stations)	111374	85

The blue information bar will tell you what is included in the LIST PRICE and what you need to choose to order a complete attachment. It may also include other helpful information.



**INCLUDES: 612 TRENCHER, PTO DRIVE SHAFT (20-45 HP) AND HYDRAULIC HOOK-UP KIT**  
**TO ORDER: CHOOSE TRENCHER ASSEMBLY, BOOM & CRUMBER ASSEMBLY AND CHAIN & TEETH ASSEMBLY**

The warning box contains important information pertaining to the attachment and prime mover and/or other safety information.



**IMPORTANT: Front counter weight may be necessary for proper transportation of the tractor and trencher attachment. Requires rear hydraulics to run machine.**

## TRENCHER MODEL 330

### 3-POINT HITCH (CATEGORY 1) HYDROSTATIC TRANSMISSION AND REAR REMOTES



- Category 1ASAE S217.12 standard, 3-point mount for 15-30 PTO HP hydrostatic tractors
- Maintenance free PTO shaft drive with automatic slip clutch for overload protection
- 14" discharge auger
- 30" & 36" digging depth available to fit most applications
- 38,000 lb 1.654" anti-back flex-chain for tooth pattern versatility to support many soil types and conditions
- Compatible with model 615 chains
- ASAE S278.6 standard quick attach compatible
- Support stand is a standard feature

#### Specifications - Transport

Trench Depth w/ Auger at 65° Digging Angle	Chain Width	Recom'd Trenching Angle	Headshaft Height (Auger Touching Ground)	Overall Length	Overall Width	Overall Height	Spoil Discharge Reach	Length from 3-Point to Headshaft (center of gravity)	Transport Angle	Weight w 6"x 36" Chain, Boom & Crumber
30"	3", 4.5", 6", 8"	65°	8.5"	73"	38"	29"	21"	24"	48°	650 lbs
36"	3", 4.5", 6", 8"	65°	8.5"	79"	38"	29"	21"	24"	48°	650 lbs

#### Specifications - Hydraulic System

Operating Hydraulic System	Rear PTO RPM Rating	Rear PTO HP Rating
2,000 to 2,500 PSI	540 RPM	15 to 30 HP



**IMPORTANT:** Front counter weight may be necessary for proper transportation of the tractor and trencher attachment. Requires rear hydraulics to run machine.

## TRENCHER MODEL 330



**TO ORDER: CHOOSE TRENCHER ASSEMBLY, BOOM & CRUMBER ASSEMBLY AND CHAIN & TEETH ASSEMBLY**

#### TRENCHER ASSEMBLY (INCLUDES 4 FOOT HOSES WITH 6 FJX HOSE END)

	ORDER CODE	SHIP WEIGHT (LBS)	
330 trencher assembly, 15 - 30 HP	111135	465	\$8,791

#### BOOM & CRUMBER ASSEMBLIES

	ORDER CODE	SHIP WEIGHT (LBS)	
30" digging depth (29 stations)	111385	85	\$1,219
36" digging depth (32 stations)	111374	85	\$1,239

330 TRENCHER CONTINUED ON THE NEXT PAGE

# TRENCHERS

## TRENCHER MODEL 330 CONT.

TRENCHERS

CHAIN & TEETH ASSEMBLIES (MUST MATCH BOOM & CRUMBER SIZE)		ORDER CODE	SHIP WEIGHT (LBS)	LIST PRICE
<b>38,000# / 1.654 Pitch / Cut-Type Teeth / Tooth Every Station</b>				
for 30" boom 3" wide chain		112533	65	\$1,226
for 30" boom 4.5" wide chain		16687	70	\$1,215
for 30" boom 6" wide chain		16686	76	\$1,358
for 30" boom 8" wide chain		16685	88	\$1,438
for 36" boom 3" wide chain		112531	70	\$1,325
for 36" boom 4.5" wide chain		89822	76	\$1,366
for 36" boom 6" wide chain		89823	84	\$1,287
for 36" boom 8" wide chain		89824	96	\$1,551
<b>38,000# / 1.654 Pitch / 70/30 Combination Shark-Type / Cup-Type Teeth / Tooth Every Station</b>				
for 30" boom 3" wide chain		112454	70	\$1,505
for 30" boom 4.5" wide chain		112562	73	\$1,584
for 30" boom 6" wide chain		18767	80	\$1,584
for 30" boom 8" wide chain		18768	86	\$1,608
for 36" boom 3" wide chain		112453	100	\$1,496
for 36" boom 4.5" wide chain		89825	76	\$1,740
for 36" boom 6" wide chain		89826	83	\$1,620
for 36" boom 8" wide chain		89827	92	\$1,956
OPTIONS		ORDER CODE	SHIP WEIGHT (LBS)	LIST PRICE
Valve assembly for use when tractor is not equipped with rear remote couplers		112573	20	\$843
REPLACEMENT PARTS		ORDER CODE	SHIP WEIGHT (LBS)	LIST PRICE
Tooth Left 1.654 - Cup Style		31595		\$11
Tooth Right 1.654 - Cup Style		31596		\$11
Tooth Center 1.654 - Shark Style		31592		\$28
Tooth Left 1.654 - Shark Style		31593		\$34
Tooth Right 1.654 - Shark Style		31594		\$34
Digging Chain,30" - Bare		17013		POR
Digging Chain,36" - Bare		17014		\$736
Hose .25x48 6fj-6fj90s 100r2at		37751		POR
Cylinder Assembly		111389		\$614

## TRENCHER MODEL 612

### 3-POINT HITCH (CATEGORY 1) HYDROSTATIC TRANSMISSION AND REAR REMOTES



- PTO shaft-drive with heavy duty slip clutch for overload protection
- Gearbox drive with chain reduction to the headshaft giving productive digging chain speed
- 24" discharge auger, places dirt well away from the trench
- Several tooth options available
  - cup
  - shark
  - rock & frost
- 50,000 lb 2" anti-back flex-chain

#### Specifications - 3-Point Mounting

Trench Depth	Trench Width	Trenching Angle	Auger Diameter	Width	Headshaft Height (Auger Touching Ground)	Length from 3-Point to Headshaft	Spoil Discharge Reach	Transport Height	Center of Trencher to End of Auger	Trencher Length with 4' Boom
30", 36", 48", 60"	6", 8", 10", 12"	65°	24"	43"	12"	24"	29"	Varies	27"	96"

#### Maximum Trenching Depths Based on Trench Width

6" Wide	8" Wide	10" Wide	12" Wide
60" Deep	48" Deep	36" Deep	30" Deep

#### Digging Chain Specifications

Double Standard, anti-backflex	Standard Chain Pitch
50,000 lbs	2"



**IMPORTANT:** Front counter weight may be necessary for proper transportation of the tractor and trencher attachment. Shipped fully assembled, ready to mount on tractor.

## TRENCHER MODEL 612



**INCLUDES:** 612 TRENCHER, PTO DRIVE SHAFT (20-45 HP) AND HYDRAULIC HOOK-UP KIT  
**TO ORDER:** CHOOSE TRENCHER ASSEMBLY, BOOM & CRUMBER ASSEMBLY AND CHAIN & TEETH ASSEMBLY

#### TRENCHER ASSEMBLY

	ORDER CODE	SHIP WEIGHT (LBS)	LIST PRICE
612 Trencher	78592	615	\$10,418

#### BOOM & CRUMBER ASSEMBLY

	ORDER CODE	SHIP WEIGHT (LBS)	LIST PRICE
30" digging depth 23 stations	110631	101	\$773
36" digging depth 26 stations	110632	111	\$791
48" digging depth 33 stations	110633	149	\$948
60" digging depth 40 stations	110634	188	\$1,349



**NOTE:** 48" & 60" boom & crumber assembly includes chain tightener kit, not required on 30" and 36" assemblies due to design.

612 TRENCHER CONTINUED ON THE NEXT PAGE

# TRENCHERS

## TRENCHER MODEL 612 CONT.

TRENCHERS

CHAIN & TEETH ASSEMBLY (MUST MATCH BOOM & CRUMBER SIZE)		ORDER CODE	SHIP WEIGHT (LBS)	LIST PRICE
<b>50,000# Chain / 2.00" Pitch / Tooth Every Station</b>				
for 30" boom 6" wide chain		80044	107	\$981
for 30" boom 8" wide chain		80045	115	\$1,058
for 30" boom 10" wide chain		80046	127	\$1,181
for 30" boom 12" wide chain		80047	142	\$1,427
for 36" boom 6" wide chain		80048	132	\$1,134
for 36" boom 8" wide chain		80049	139	\$1,209
for 36" boom 10" wide chain		80050	152	\$1,503
for 36" boom 12" wide chain		80822	190	\$1,672
for 48" boom 6" wide chain		80051	157	\$1,375
for 48" boom 8" wide chain		80052	167	\$1,474
for 60" boom 6" wide chain		80053	173	\$1,532
<b>50,000# Chain / 2.00" Pitch / Tooth Every Other Station</b>				
for 30" boom 6" wide chain		80034	86	\$603
for 30" boom 8" wide chain		80035	91	\$880
for 30" boom 10" wide chain		80036	95	\$1,086
for 30" boom 12" wide chain		80037	105	\$1,098
for 36" boom 6" wide chain		80038	100	\$926
for 36" boom 8" wide chain		80039	105	\$961
for 36" boom 10" wide chain		80040	113	\$1,120
for 48" boom 6" wide chain		80041	127	\$1,134
for 48" boom 8" wide chain		80042	134	\$1,209
for 60" boom 6" wide chain		80043	149	\$1,388
<b>Combination Chain Assemblies: 50/50 Rock &amp; Frost / Cup Teeth</b>				
for 30" boom 6" wide chain		83702	145	\$562
for 36" boom 6" wide chain		83703	165	\$3,468
for 48" boom 6" wide chain		83704	205	\$3,878
<b>Combination Chain Assemblies: 70/30 Aggressive Shark-Style / Cup Teeth</b>				
for 30" boom 6" wide chain		31539	99	\$1,242
for 36" boom 6" wide chain		31540	117	\$1,462
for 48" boom 6" wide chain		31541	155	\$1,782
for 60" boom 6" wide chain		31542	195	\$2,091
<b>Shark-Style Tooth Chain Assemblies: 50,000# ABF Chain / 2.00" Pitch</b>				
for 30" boom 6" wide chain		31543	105	\$813
for 36" boom 6" wide chain		31544	130	\$1,562
for 48" boom 6" wide chain		31545	170	\$1,745
<b>OPTIONS</b>		<b>ORDER CODE</b>	<b>SHIP WEIGHT (LBS)</b>	
stand for model 612 trencher		88167	20	\$177

special paint color - contact factory for order code

## TRENCHER MODEL 612 CONT.

REPLACEMENT PARTS	ORDER CODE	SHIP WEIGHT (LBS)	LIST PRICE
Tooth,Left,2.00p - Cup Style	54431		\$21
Tooth,Right,2.00p - Cup Style	54432		\$21
Tooth Left 2.00 - Shark Style	31600		\$54
Tooth Center 2.00 - Shark Style	31599		\$37
Tooth Right 2.00 - Shark Style	31601		\$54
Hose .38x50 6mp-6fj 100r2at Hs	35871		POR
Cylinder Assembly	60964		\$731

## TRENCHER MODEL 625 UNIVERSAL SKID-STEER MOUNTING



- 30", 36", 42" & 48" digging depth available to fit most applications
- Heavy-duty boom & crumpler with replaceable wear strips
- Allows tight fit with single side spoil augering
- Replaces dedicated machines at a fraction of the cost
- Several tooth options available
  - cup
  - shark
  - rock & frost
- 50,000 lb 2" anti-back flex-chain for tooth pattern versatility to support many soil types and conditions
- Two position manual side shift mounting with optional infinite position using hydraulic side shift cylinder assembly

Specifications									
Boom Size	Trench Depth w/ Auger at 65° Digging Angle	Chain Width	Recom'd Trenching Angle	Headshaft Height (Auger Touching Ground)	Overall Length	Overall Width	Overall Height	Spoil Discharge Reach	Side Shift, Right of Center
30"	30"	6", 8", 10", 12"	65°	8"	66"	53"	32"	18"	17"
36"	36"	6", 8", 10"	65°	8"	73"	53"	32"	18"	17"
42"	42"	6", 8", 10"	65°	8"	79"	53"	32"	18"	17"
48"	48"	6", 8"	65°	8"	86"	53"	32"	18"	17"

Specifications - Hydraulic System	
GPM Requirements	Operating Pressure
Min 14 / Max 22	2000 to 3000 PSI

## TRENCHER MODEL 625

COMPLETE 625 TRENCHER WITH BOOM, CHAIN/TEETH ASSEMBLIES & HOSES	ORDER CODE	SHIP WEIGHT (LBS)	LIST PRICE
36" digging depth, 6" wide chain, tooth every station	103584	962	\$7,825
48" digging depth, 6" wide chain, tooth every station	117765	1150	\$7,786
48" digging depth, 6" wide chain, 70/30 tooth every station	117766	1150	\$8,195

625 TRENCHER CONTINUED NEXT PAGE

# TRENCHERS

## TRENCHER MODEL 625 CONT.



**TO ORDER: CHOOSE TRENCHER ASSEMBLY, BOOM & CRUMBER ASSEMBLY, CHAIN & TEETH ASSEMBLY AND HYDRAULIC KIT**

TRENCHERS

TRENCHER ASSEMBLY		ORDER CODE	SHIP WEIGHT (LBS)	LIST PRICE
model 625 trencher 14 to 22 GPM		89220	850	\$5,194

BOOM & CRUMBER ASSEMBLIES		ORDER CODE	SHIP WEIGHT (LBS)	LIST PRICE
30" digging depth (24 stations)		89281	104	\$979
36" digging depth (27 stations)		89282	115	\$973
42" digging depth (31 stations)		89283	128	\$1,079
48" digging depth (34 stations)		89284	140	\$1,103

CHAIN & TEETH ASSEMBLIES (MUST MATCH BOOM & CRUMBER SIZE)		ORDER CODE	SHIP WEIGHT (LBS)	LIST PRICE
<b>50,000# Chain / 2.00" Pitch / Tooth Every Station</b>				
for 30" boom 6" wide chain		79154	110	\$981
for 30" boom 8" wide chain		79155	118	\$1,115
for 30" boom 10" wide chain		79156	130	\$1,342
for 30" boom 12" wide chain		79157	145	\$1,433
for 36" boom 6" wide chain		79099	135	\$1,340
for 36" boom 8" wide chain		79100	142	\$1,125
for 36" boom 10" wide chain		79158	155	\$1,387
for 36" boom 12" wide chain		81120	190	\$1,593
for 42" boom 6" wide chain		82114	148	\$1,161
for 42" boom 8" wide chain		82115	156	\$1,324
for 42" boom 10" wide chain		82116	170	\$1,539
for 48" boom 6" wide chain		79101	160	\$1,553
for 48" boom 8" wide chain		79102	170	\$1,567
<b>50,000# Chain / 2.00" Pitch / Tooth Every Other Station</b>				
for 30" boom 6" wide chain		79181	89	\$828
for 30" boom 8" wide chain		79182	94	\$1,401
for 30" boom 10" wide chain		79183	98	\$1,589
for 30" boom 12" wide chain		79184	108	\$1,134
for 36" boom 6" wide chain		79185	103	\$1,009
for 36" boom 8" wide chain		79186	108	\$981
for 36" boom 10" wide chain		79187	116	\$1,011
for 42" boom 6" wide chain		82117	117	\$1,073
for 42" boom 8" wide chain		82118	123	\$1,067
for 42" boom 10" wide chain		82119	132	\$1,128
for 48" boom 6" wide chain		79188	130	\$1,134
for 48" boom 8" wide chain		79189	137	\$1,209

625 TRENCHER CONTINUED NEXT PAGE

## TRENCHER MODEL 625 CONT.

CHAIN & TEETH ASSEMBLIES (MUST MATCH BOOM & CRUMBER SIZE)	ORDER CODE	SHIP WEIGHT (LBS)	LIST PRICE
<b>Combination Chain Assembly: 50/50 Rock &amp; Frost / Bullet Teeth / Cup Teeth</b>			
for 30" boom 6" wide chain	83706	152	\$2,509
for 36" boom 6" wide chain	83707	182	\$2,632
for 42" boom 6" wide chain	83708	212	\$2,948
for 48" boom 6" wide chain	83709	242	\$3,197
<b>Combination Chain Assembly: 70/30 Aggressive Shark-Style Teeth / Cup Teeth</b>			
for 30" boom 6" wide chain	31546	118	\$1,195
for 36" boom 6" wide chain	31547	133	\$1,443
for 42" boom 6" wide chain	31563	153	\$1,562
for 48" boom 6" wide chain	31548	168	\$1,601
<b>Shark-Style Tooth Chain Assembly: 50,000# ABF Chain 2.00" Pitch</b>			
for 30" boom 6" wide chain	31549	121	\$1,449
for 36" boom 6" wide chain	31550	137	\$1,692
for 42" boom 6" wide chain	31551	151	POR
for 48" boom 6" wide chain	31552	172	\$2,088

HYDRAULIC KITS	ORDER CODE	SHIP WEIGHT (LBS)	LIST PRICE
97" long hose/coupler universal flat face	19709	20	\$506
97" long hoses & case old style couplers (XT series)	89603	20	\$569
82" long hoses ONLY	89604	15	\$245
97" long hoses ONLY (XT series)	89605	17	\$339
<b>Skid-Steer Loader Universal Hydraulic Quick Couplers</b>			
flat face female coupler (.5" pipe thread)	84925	2	\$87
flat face male coupler (.5" pipe thread)	84924	2	\$59
flat face female coupler (12 o-ring)	22518	2	\$80
flat face male coupler (12 o-ring)	22519	2	\$55

OPTIONS	ORDER CODE	SHIP WEIGHT (LBS)	LIST PRICE
hydraulic side shift with diverter valve	89412	52	\$1,136
hydraulic side shift without diverter valve (requires 2 sets of auxiliary outlets)	89279	40	\$362

REPLACEMENT PARTS	ORDER CODE	SHIP WEIGHT (LBS)	LIST PRICE
Tooth,Left,2.00p - Cup Style	54431		\$21
Tooth,Right,2.00p - Cup Style	54432		\$21
Tooth Left 2.00 - Shark Style	31600		\$54
Tooth Center 2.00 - Shark Style	31599		\$37
Tooth Right 2.00 - Shark Style	31601		\$54
Chain,Trencher,2.00p, Bare	79018		\$24

# TRENCHERS

## TRENCHER MODEL 640 UNIVERSAL SKID-STEER MOUNTING

TRENCHERS



- 5 motor options to match the flow of many skid-steer loaders
- Two position manual side shaft mounting with optional infinite position
- 30", 36", 42" & 48" digging depth available to fit most applications, 60" high flow only
- Mechanical side shift
- Fixed length booms available featuring spring-loaded, self adjusting idler with full rock guards
- Heavy-duty boom & crumber
- Several tooth options available
  - cup
  - shark
  - rock & frost
- 50,000 lb 2" anti-back flex-chain for tooth pattern versatility to support many soil types and conditions

Specifications										
Boom Size	Trench Depth w/ Auger at 65° Digging Angle	Chain Width	Recom'd Trenching Angle	Headshaft Height (Auger Touching Ground)	Overall Length	Overall Width	Overall Height	Spoil Discharge Reach	Side Shift, Right of Center	
30"	30"	6", 8", 10", 12"	65°	8"	66"	53"	32"	18"	17"	
36"	36"	6", 8", 10", 12"	65°	8"	73"	53"	32"	18"	17"	
42"	42"	6", 8", 10"	65°	8"	79"	53"	32"	18"	17"	
48"	48"	6", 8"	65°	8"	86"	53"	32"	18"	17"	
60"	60"	6"	65°	8"	94"	55"	57"	24"	17"	

Specifications - Hydraulic System		
GPM Requirements (standard flow)	GPM Requirements (high flow)	Operating Pressure
14 to 28	29 to 44	Max 3500 PSI

## TRENCHER MODEL 640



**TO ORDER: CHOOSE TRENCHER ASSEMBLY, BOOM & CRUMBER ASSEMBLY, CHAIN & TEETH ASSEMBLY AND HYDRAULIC KIT**

COMPLETE 640 TRENCHER WITH BOOM & CHAIN/TEETH ASSEMBLIES (INLCLUDES HOSES)-MUST ORDER COUPLERS	ORDER CODE	SHIP WEIGHT (LBS)	LIST PRICE
48" digging depth, 6" wide chain, 18-26 gpm, 70/30 tooth every station	122395	1158	\$8,753

TRENCHER ASSEMBLY	ORDER CODE	SHIP WEIGHT (LBS)	LIST PRICE
<b>Basic Trencher (Includes Hoses) - must order couplers</b>			
model 640 14-18 GPM (Standard Flow)	100268	850	\$6,175
model 640 18-26 GPM (Standard Flow)	100269	850	\$6,013
model 640 25-28 GPM (Standard Flow)	102326	850	\$6,205
model 640 29-35 GPM drain line required (High Flow)	100270	900	\$7,768
model 640 36-44 GPM drain line required (High Flow)	102325	900	\$7,812

640 TRENCHER CONTINUED NEXT PAGE

## TRENCHER MODEL 640 CONT.

BOOM & CRUMBER ASSEMBLIES		ORDER CODE	SHIP WEIGHT (LBS)	LIST PRICE
30" digging depth (24 stations)	<b>\$1,532</b>	892281	104	\$979
36" digging depth (27 stations)		89282	115	\$973
42" digging depth (31 stations)		89283	128	\$1,079
48" digging depth (34 stations)		89284	140	\$1,103
60" digging depth (40 stations) (for 100270 / 102325)		100272	180	\$1,890

CHAIN & TEETH ASSEMBLIES (MUST MATCH BOOM & CRUMBER SIZE)		ORDER CODE	SHIP WEIGHT (LBS)	LIST PRICE
<b>50,000# Chain / 2.00" Pitch / Tooth Every Station</b>				
for 30" boom 6" wide chain		79154	110	\$981
for 30" boom 8" wide chain		79155	118	\$1,115
for 30" boom 10" wide chain		79156	130	\$1,342
for 30" boom 12" wide chain		79157	145	\$1,433
for 36" boom 6" wide chain		79099	135	\$1,340
for 36" boom 8" wide chain		79100	142	\$1,125
for 36" boom 10" wide chain		79158	155	\$1,387
for 36" boom 12" wide chain		81120	190	\$1,593
for 42" boom 6" wide chain		82114	148	\$1,161
for 42" boom 8" wide chain		82115	156	\$1,324
for 42" boom 10" wide chain		82116	170	\$1,539
for 48" boom 6" wide chain		79101	160	\$1,553
for 48" boom 8" wide chain		79102	170	\$1,567
for 60" boom 6" wide chain		80053	173	\$1,532
<b>50,000# Chain / 2.00" Pitch / Tooth Every Other Station</b>				
for 30" boom 6" wide chain		79181	89	\$828
for 30" boom 8" wide chain		79182	94	POR
for 30" boom 10" wide chain		79183	98	POR
for 30" boom 12" wide chain		79184	108	\$1,134
for 36" boom 6" wide chain		79185	103	\$1,009
for 36" boom 8" wide chain		79186	108	\$981
for 36" boom 10" wide chain		79187	116	\$1,011
for 42" boom 6" wide chain		82117	117	\$1,073
for 42" boom 8" wide chain		82118	123	\$1,067
for 42" boom 10" wide chain		82119	132	\$1,128
for 48" boom 6" wide chain		79188	130	\$1,134
for 48" boom 8" wide chain		79189	137	\$1,209
for 60" boom 6" wide chain		80043	149	\$1,388
<b>Combination Chain Assembly: 50/50 Rock &amp; Frost / Bullet Teeth / Cup Teeth</b>				
for 30" boom 6" wide chain		83706	152	\$2,509
for 36" boom 6" wide chain		83707	182	\$2,632
for 42" boom 6" wide chain		83708	212	\$2,948
for 48" boom 6" wide chain		83709	242	\$3,197
for 60" boom 6" wide chain		83705	265	\$3,959

640 TRENCHER - GROUP 3 CONTINUED NEXT PAGE

# TRENCHERS

## TRENCHER MODEL 640 CONT.

CHAIN & TEETH ASSEMBLIES CONT. (MUST MATCH BOOM & CRUMBER SIZE)		ORDER CODE	SHIP WEIGHT (LBS)	LIST PRICE
<b>Combination Chain Assembly: 70/30 Aggressive Shark-Style Teeth / Cup Teeth</b>				
for 30" boom 6" wide chain		31546	118	\$1,195
for 36" boom 6" wide chain		31547	133	\$1,443
for 42" boom 6" wide chain		31563	153	\$1,562
for 48" boom 6" wide chain		31548	168	\$1,601
for 60" boom 6" wide chain		31542	195	\$2,091
<b>Shark-Style Tooth Chain Assembly: 50,000# ABF Chain 2.00" Pitch</b>				
for 30" boom 6" wide chain		31549	121	\$1,449
for 36" boom 6" wide chain		31550	137	\$1,692
for 42" boom 6" wide chain		31551	151	\$1,697
for 48" boom 6" wide chain		31552	172	\$2,088
QD SETS		ORDER CODE	SHIP WEIGHT (LBS)	LIST PRICE
<b>QD Sets Standard Flow</b>				
.50" body flat face couplers		23609	4	\$173
.62" body flat face couplers		124359	4	\$552
<b>QD Sets High Flow</b>				
.50" body with .38" male drain		119996	5	\$277
.50" body with .38" female drain		119997	5	\$311
.62" body with .38" male drain		119998	5	\$454
.62" body with .38" female drain		119999	5	\$558
.75" body with .25" male drain		120000	5	\$572
.75" body with .38" male drain		120001	5	\$583
.75" body with .38" female drain		120002	5	\$596
.75" body with .50" male drain		120003	5	\$425
OPTIONS		ORDER CODE	SHIP WEIGHT (LBS)	LIST PRICE
most paint color options available		contact factory		
REPLACEMENT PARTS		ORDER CODE	SHIP WEIGHT (LBS)	LIST PRICE
Tooth,Left,2.00p - Cup Style		54431		\$21
Tooth,Right,2.00p - Cup Style		54432		\$21
Tooth Left 2.00 - Shark Style		31600		\$54
Tooth Center 2.00 - Shark Style		31599		\$37
Tooth Right 2.00 - Shark Style		31601		\$54
Chain,Trencher,2.00p, Bare		79018		\$24
Hose .62x123 10fj-12mb 100r19 Hs - Std Flow		38231		POR
Hose .75x123 12fj-12mb 100r19 Hs (Ce) - High Flow		38279		\$197
Hose .25x132 6fj-6fj 100r2at Hs - High Flow		37482		\$109

## TRENCHER CHAIN SELECTION GUIDE

### TOOTH EVERY STATION (TES)

Designed for standard digging conditions, light to moderately compacted, sandy, loam soils and loosely-packed gravelly soils. Typically good digging conditions.

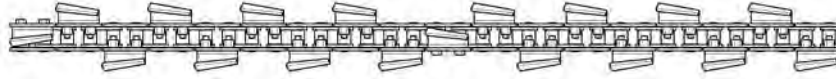

### TOOTH EVERY OTHER STATION (TEOS)

Tooth pattern designed to give the most production in wet, sticky conditions such as gumbo, wet clay, etc. TEOS allows the sticky soils to be discharged as it comes around the head shaft sprocket allowing the auger to pick it up and discharge spoil to the side of the trench. The TES chain has a tendency to hold the sticky soils causing build-up in the chain and loss of production.

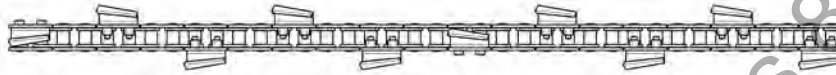

### ROCK & FROST CHAIN 50/50: COMBINATION 50% ROCK & FROST / 50% CUP TEETH (R&F)

The rock and frost chain will give the highest production in frozen ground, highly compacted soils and rock, allowing the cup teeth to pick up and clean the trench. The R&F chain is very aggressive in tough conditions, but is not as productive in the lighter, normal digging conditions.

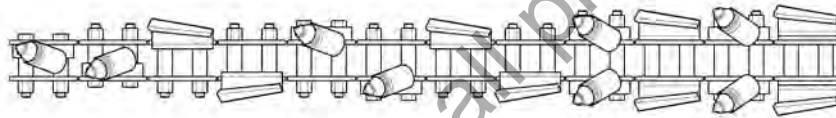

### SHARK TOOTH CHAIN 70/30: COMBINATION 70% SHARK / 30% CUP TEETH (70/30)

The 70/30 chain should be applied in compacted soils, light frozen ground, baked hard clay, shale or rocky soils. The aggressive shark teeth will slice, break and relieve the tough soils, allowing the cup teeth to follow and clean the trench. As with the R&F chain, the 70/30 chain will not be as productive in the lighter, normal conditions as the TES chain.

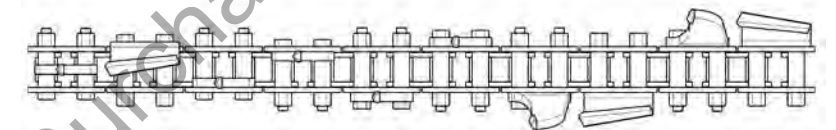

### FULL SHARK TOOTH CHAIN (100% SHARK TEETH)

The full shark tooth chain is recommended in fracturable rock, shale, caliche or conditions with little or no loose soil. This chain will not efficiently clean the trench in sand, silt and high-moisture clay conditions.

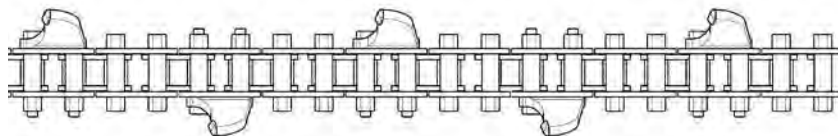

### CHAIN WIDTHS

4" wide chain

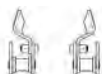

6" wide chain



8" wide chain

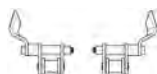

10 - 12" wide chain

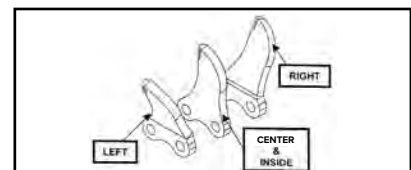

# VIBRATORY PLOWS

## VIBRATORY PLOW



- 12' turning radius
- Rotating coulter wheel frame mounted
- Optional hydraulic steering assembly
- Optional cable chute blades, reel mount, and pulling accessories available

## VIBRATORY PLOW FOR COMPACT TRACTORS



VIBRATORY PLOW ASSEMBLY	ORDER CODE	SHIP WEIGHT (LBS)	LIST PRICE
Model VP10 8 to 11 GPM	19733	467	\$11,851
Model VP10 10 to 14 GPM	19734	467	\$12,696

HYDRAULIC KITS	ORDER CODE	SHIP WEIGHT (LBS)	LIST PRICE
without steering, .50" poppet couplers	19380	10	\$343
without steering, .50" flat face couplers	19381	10	\$596
with steering, .50" poppet couplers*	19382	25	\$776
with steering, .50" flat face couplers*	19383	25	\$1,284

\*Skid-Steer must have two sets of auxiliary hydraulics

MOUNTING KITS	ORDER CODE	SHIP WEIGHT (LBS)	LIST PRICE
3-point category I mounting kit	101827	45	\$1,112

VIBRATORY PLOW BLADES	ORDER CODE	SHIP WEIGHT (LBS)	LIST PRICE
<b>.375" (3/8") Wide Blade</b>			
.375" blade 20°, 1" clevis, 6" to 12" depth	19325	25	\$382
.375" blade 30°, 1" clevis, 6" to 12" depth	19441	20	\$480
.375" blade 20°, 1" clevis, 12" to 18" depth	18690	25	\$343
.375" blade 30°, 1" clevis, 12" to 18" depth	2007030	25	\$489
<b>.50" (1/2") Wide Chute Blade</b>			
.50" chute blade 20°, 6" to 12" depth	19442	40	\$497
.50" chute blade 30°, 6" to 12" depth	19443	40	\$640
.50" chute blade 20°, 12" to 18" depth	19444	45	\$499
.50" chute blade 30°, 12" to 18" depth	19445	45	\$565
.50" chute blade 20°, 20" to 24" depth	109214	31	\$433
.50" chute blade 30°, 18" to 24" depth	112256	53	\$751

OPTIONS	ORDER CODE	SHIP WEIGHT (LBS)	LIST PRICE
pull bullet assembly, 2.5" dia	17754	5	\$158
cable pull grip, 1" to 1.24" cable	2001171	3	\$818
cable pull grip, .75" to .99" dia.	100435	3	\$766
cable pull grip, 1.25" to 1.49" dia.	100436	3	\$719
pipe bullet assembly, 1" to 1.5" pipe	18740	5	\$797
cable reel mount, 24" max. dia. reel	19085	26	\$684
hydraulic steering assembly (Must select one steering conversion kit below)	18739	29	\$1,296
steering conversion kit, .50" poppet couplers	19732	20	\$594
steering conversion kit, .50" flat face couplers	19735	20	\$712

# VIBRATORY ROLLERS

## VIBRATORY ROLLER



- Protected & isolated hydraulic drive
- High production smooth & padded rollers available
- Steel drum has adjustable steel scraper blade between the frame and drum ensuring smooth and uniform compaction

**!** **IMPORTANT: Flow range 14 to 22 GPM and max pressure of 3,000 PSI**

Specifications											
Model #	Overall Width	Drum Width	Overall Height	Overall Length	Drum Diameter	Operating Weight (lbs)	Dynamic Force (lbs)	Vibrating Speed (vpm)	Vibrating Weight (lbs)	Drum Oscillation/Tile	Hydraulic Motor Flow (gpm)
<b>Smooth Drum</b>											
105061	61"	48"	31"	39"	24"	1680	5750	2600	935	15°	25
105062	72"	66"	31"	39"	24"	2150	7800	2600	1190	15°	25
105063	79"	73"	31"	39"	24"	2300	8550	2600	1290	15°	25
105064	90"	84"	31"	39"	24"	2530	9370	2600	1440	15°	25
<b>Padded Drum</b>											
105065	61"	48"	31"	39"	20"	1630	5750	2600	507	15°	25
105066	72"	66"	31"	39"	24"	2085	7800	2600	935	15°	25
105067	79"	73"	31"	39"	24"	2230	8550	2600	1190	15°	25
105068	90"	84"	31"	39"	24"	2455	9370	2600	1290	15°	25

## VIBRATORY ROLLER FOR SKID-STEER LOADERS



**i** **INCLUDES: VIBRATORY ROLLER, 80" HOSES AND .50 BODY FLAT FACE COUPLERS**

	ORDER CODE	SHIP WEIGHT (LBS)	LIST PRICE
<b>Smooth Drum</b>			
48" smooth drum	105061	1680	\$13,724
66" smooth drum	105062	2150	\$14,021
73" smooth drum	105063	2300	\$14,619
84" smooth drum	105064	2530	\$15,268
<b>Padded Drum</b>			
48" padded drum	105065	1630	\$13,154
66" padded drum	105066	2085	\$14,974
73" padded drum	105067	2230	\$15,621
84" padded drum	105068	2455	\$16,532

# MISCELLANEOUS

MISCELLANEOUS

HOSE SAVER SPRING KIT	ORDER CODE	SHIP WEIGHT (LBS)	LIST PRICE
<b>Allows adjustment of hose routing to prevent hose pinching between quick attach implement and power unit. Easily installed by welding #10136 on any implement or loader attachment that uses hydraulics.</b>			
.25 ID hose	103177	5	\$70
.38 ID hose	103178	5	\$64
.50 ID hose	103179	5	\$69
.62 ID hose	103454	5	\$70
.75 ID hose	103455	5	\$70
nut, spring base weld-on	10136	2	\$20

Add Surcharge to all products 8.85%

# POWERFUL ATTACHMENT TOOLS



**SELECTION.  
INNOVATION.  
PERFORMANCE.**



Add Surcharge on Products 8.85%



**PALADIN®**